



KERN & Sohn GmbH

Ziegelei 1
D-72336 Balingen
E-Mail: info@kern-sohn.com

Phone: +49-[0]7433- 9933-0
Fax: +49-[0]7433-9933-149
Internet: www.kern-sohn.com

Operating manual

Analysis and precision balances

KERN AET, PET, ILT-NM

Version 2.0
01/2015
GB



AET / PET / ILT_NM-BA-e-1520



KERN AET / PET / ILT_NM

Version 2.0 01/2015

Operating manual

Analysis and precision balances

Contents

1	TECHNICAL DATA	7
1.1	Dimensions	12
1.2	Connections / interfaces:	16
2	APPLIANCE OVERVIEW	17
3	OPERATING ELEMENTS	20
3.1	Keyboard overview	20
3.2	Overview of display	21
4	BASIC INSTRUCTIONS	23
4.1	Proper use	23
4.2	Improper Use	23
4.3	Warranty	24
4.4	Monitoring of Test Resources	24
5	BASIC SAFETY PRECAUTIONS	25
5.1	Pay attention to the instructions in the Operation Manual	25
5.2	Personnel training	25
6	TRANSPORT AND STORAGE	25
6.1	Testing upon acceptance	25
6.2	Packaging / return transport	25
7	UNPACKING, SETUP AND COMMISSIONING	28
7.1	Installation Site, Location of Use	28
7.2	Unpacking and checking	28
7.2.1	Scope of delivery / serial accessories	28
7.2.2	Placing	29
7.3	Mains connection	32
7.4	Commissioning	33
7.5	Shutting down / standby mode	36
7.6	Basic Operation	37
7.6.1	Simple weighing	37
7.6.2	Zeroing	37
7.6.3	How to select a weighing unit	38
7.6.4	Weighing with tare	39
7.7	Connection of peripheral devices	40

8	SYSTEM SETTINGS (MENU)	41
8.1	Adjustment	45
8.1.1	Internal adjustment (Not available for ILT 50K-4C)	47
8.1.2	External adjustment (For weighing scales without type approval only)	48
8.1.3	User adjustment (Weighing scales without type approval only)	49
8.1.4	Adjustment test	50
8.1.5	Automatic adjustment (For weighing scales without type approval only)	51
8.1.6	Adjustment log	51
8.1.7	GLP draft	52
8.2	User	54
8.2.1	Create new user (authorisation restricted to administrator)	55
8.2.2	Editing user data	58
8.2.3	Copying deleting and editing user data	58
8.3	Authorisations	59
8.4	Profiles	62
8.4.1	Create new profile (authorisation restricted to administrator)	62
8.4.2	Defining profile	64
8.5	Communication parameters	70
8.5.1	COM 1 / COM 2	71
8.5.2	Ethernet / IP	71
8.5.3	TCP	72
8.6	Equipment	73
8.6.1	Computer	73
8.6.2	Printer	77
8.6.3	Barcode scanner	80
8.6.4	Transponder card scanner	82
8.6.5	Second display	82
8.6.6	Ambient conditions module	83
8.7	Inputs / outputs	84
8.7.1	inputs	84
8.7.2	Outputs	85
8.8	General parameters	86
8.8.1	User language	86
8.8.2	Entering date / time	87
8.8.3	Signal tone when pressing button	87
8.8.5	Setting sensitivity of sensors	89
8.8.6	Auto test	89
8.8.7	Setting start logo (authorisation required)	95
8.8.8	Read error memory (Authorisation required)	95
8.9	Environment	96
8.10	Info about system	98
9	APPLICATION SETTINGS	99
9.1	Selecting an application	99
9.2	Selecting parameters	100

10	WEIGHING	101
10.1	Selecting an application	101
10.2	Selecting parameters	102
10.2.1	Settings	102
10.2.2	Buttons	109
10.2.3	< Select information texts >	110
10.2.4	Define report	111
10.2.5	Profile	117
11	PARTS COUNTING	118
11.1	Selecting an application	118
11.2	Selecting parameters	119
11.2.1	Settings	119
11.3	Carry out parts counting	121
11.3.1	Determination of the reference piece weight by weighing	121
11.3.2	Enter reference single weight as numerical value	123
11.3.3	Load reference single weight from the product database	124
11.4	Assigning a reference single weight to a product in the database	124
11.5	Adding up with tolerance control	125
11.6	Adding-up to target value	128
12	CHECKWEIGHING	131
12.1	Selecting an application	131
12.2	Selecting parameters	132
12.2.1	Settings	132
12.3	Carrying out checkweighing	134
12.3.1	Enter limit values via function key	134
12.3.2	Load limit values from database	136
13	DOSING	137
13.1	Selecting an application	137
13.2	Selecting parameters	138
13.2.1	Settings	138
13.2.2	Information texts	139
13.3	Carry out dosing	140
13.3.1	Enter target weight manually	140
13.3.2	Load target weight from product database	142
14	PERCENT DETERMINATION	143
14.1	Selecting an application	143
14.2	Selecting parameters	144
14.3	Carrying out percentage determination	145
14.3.1	Determination of the reference weight by weighing	145
14.3.2	Entering a reference weight as sign	146
14.3.3	Loading a reference weight from the product database	147
14.4	Tolerance control in percent determination mode	148
14.5	Determine initial weight according to target value [%]	151

15	DENSITY DETERMINATION	154
15.1	Selecting an application	154
15.2	Density determination of solids	155
15.2.1	Determine density of sinking solid bodies ($d > 1 \text{ g/cm}^3$).....	158
15.2.2	Determine density of floating solid bodies ($d > 1 \text{ g/cm}^3$)	160
15.3	Determining density of liquids.....	161
15.4	Log density determination	166
16	ANIMAL WEIGHING	168
16.1	Selecting an application	168
16.2	Selecting parameters	169
16.3	Start animal weighing	170
16.3.1	Previous adjustments	170
16.3.2	Animal weighing using manual start.....	171
16.3.3	Animal weighing using automatic start	172
17	FORMULATION	173
17.1	Selecting an application	173
17.2	Selecting parameters	175
17.2.1	Settings	175
17.2.2	Information texts	176
17.2.3	Printouts.....	178
17.3	Free Formulation (without using formula database)	179
17.4	Defining formula in database	181
17.5	Process formula from database.....	184
17.6	Weigh in formula from database according to target value.....	187
17.7	Logging formulas	188
18	STATISTICS.....	190
18.1	Selecting an application	190
18.2	Selecting parameters	191
18.3	Settings for statistical returns	191
19	PIPETTE CALIBRATION	194
19.1	Selecting an application	194
19.2	Selecting parameters	195
19.2.1	Settings	196
19.3	Defining pipette in database	197
19.4	Performing a pipette test	200
19.5	Logging a pipette test	203

20	DATABASE	205
20.1	General database operations (authorised users only)	207
20.2	General database operations (Authorised users only)	209
20.3	Description for individual databases	210
21	COMMUNICATION	214
21.1	Overview interface commands	214
21.2	General reply format	215
21.3	Detailed information to interface reports.....	216
21.3.1	Zeroing.....	216
21.3.2	Taring.....	216
21.3.3	Query tare value	217
21.3.4	Set tare value.....	217
21.3.5	Send stable weighing value in standard weighing unit.....	217
21.3.6	Send weighing value immediately in standard weighing unit	218
21.3.7	Send weighing values for all platforms immediately.....	219
21.3.8	Send stable weighing value in current weighing value.....	219
21.3.9	Send weighing value immediately in current weighing unit	220
21.3.10	Start continuous output in standard weighing unit.....	220
21.3.11	Stop continuous output in standard weighing unit	220
21.3.12	Start continuous output in current weighing unit.....	221
21.3.13	Stop continuous output in current weighing unit.....	221
21.3.14	Set value for "lower threshold"	221
21.3.15	Set value for "upper threshold"	221
21.3.16	Retrieve value for "lower threshold"	222
21.3.17	Retrieve value for "upper threshold"	222
21.3.18	Press simulation "PRINT key".....	222
21.3.19	Send all implemented messages.....	222
21.4	Data format.....	223
22	SERVICING, MAINTENANCE, DISPOSAL	224
22.1	Cleaning	224
22.2	Servicing, maintenance	224
22.3	Disposal.....	224
23	TROUBLESHOOTING GUIDE / ERROR MESSAGES	225
26	DECLARATION OF CONFORMITY	239

1 Technical data

KERN	AET 100-5M	AET 200-4M
Readability (d)	0.01 mg	0.1 mg
Weighing range (max)	110 g	220 g
Minimum load (Min)	1 mg	10 mg
Verification value (e)	1 mg	1 mg
Verification class	I	I
Reproducibility	0.05 mg	0.2 mg
Linearity	± 0.1 mg	± 0.3 mg
Stabilization time	5 sec.	2 sec.
Adjustment weight	internal	
Warm-up time	8 h	
Reference quantities at piece counting	10, 20, 50, freely selectable	
Dimensions weighing platform, stainless steel	ø 85mm	
Net weight	12.7 kg	6.2 kg
Permissible ambient condition	+18° C to +30° C	
Humidity of air	30 ~ 80 % relative (not condensing)	
Input voltage – power supply unit	110 - 230 V - 240 V AC	
Input voltage - Appliance	13.5 - 16 V	
Interfaces standard	Digital I/O, Ethernet, RS-232, USB	
Underfloor weighing device	Brackets included	
Languages User interface	German, English, French, Italian, Polish, Romanian, Spanish, Turkish, Czech, Hungarian see chap. 8.2	

KERN	AET 200-5DM	AET 500-4
Readability (d)	0.01 / 0.1 mg	0.1 mg
Weighing range (max)	82 g / 220 g	510 g
Minimum load (Min)	1 mg	-
Verification value (e)	1 mg	-
Verification class	I	-
Reproducibility	0.04 / 0.1 mg	0.2 mg
Linearity	± 0.1/0.2 mg	± 0.5 mg
Stabilization time	5 sec / 3.5 sec	2 sec.
Adjustment weight	internal	
Warm-up time	8 h	
Reference quantities at piece counting	10, 20, 50, freely selectable	
Dimensions weighing platform, stainless steel	ø 85mm	
Net weight	12.7 kg	6.2 kg
Permissible ambient condition	+18° C to +30° C	
Humidity of air	30 ~ 80 % relative (not condensing)	
Input voltage – power supply unit	110 - 230 V - 240 V AC	
Input voltage - Appliance	13.5 - 16 V	
Interfaces standard	Digital I/O, Ethernet, RS-232, USB	
Underfloor weighing device	Brackets included	
Languages User interface	German, English, French, Italian, Polish, Romanian, Spanish, Turkish, Czech, Hungarian, see chap. 8.2	

KERN	PET 600-3M	PET 1000-3M
Readability (d)	0.001 g	0.001 g
Weighing range (max)	600 g	1000 g
Minimum load (Min)	0.02 g	0.02 g
Verification value (e)	0.01 g	0.01 g
Verification class	II	II
Reproducibility	0.002 g	0.002 g
Linearity	± 0.003 g	± 0.003 g
Stabilization time	2 sec.	
Adjustment weight	internal	
Warm-up time	8 h	
Reference quantities at piece counting	10, 20, 50, freely selectable	
Dimensions weighing platform, stainless steel	128 x 128 mm	
Net weight	5.2 kg	
Permissible ambient condition	+15° C to +35° C	
Humidity of air	30 ~ 80 % relative (not condensing)	
Input voltage – power supply unit	110 - 230 V - 240 V AC	
Input voltage - Appliance	13.5 - 16 V	
Interfaces standard	Digital I/O, Ethernet, RS-232, USB	
Underfloor weighing device	Brackets included	
Languages User interface	German, English, French, Italian, Polish, Romanian, Spanish, Turkish, Czech, Hungarian, see chap. 8.2	

KERN	PET 2500-2M	PET 6000-2M
Readability (d)	0.01 g	0.01 g
Weighing range (max)	2500 g	6000 g
Minimum load (Min)	0.5 g	0.5 g
Verification value (e)	0.01 g	0.01 g
Verification class	II	II
Reproducibility	0.01 g	0.02 g
Linearity	± 0.02 g	± 0.03 g
Stabilization time	1.5 sec.	
Adjustment weight	internal	
Warm-up time	2 h	4 h
Reference quantities at piece counting	10, 20, 50, freely selectable	
Dimensions weighing platform, stainless steel	128 x 128 mm	
Net weight	5.8 kg	
Permissible ambient condition	+15° C to +35° C	
Humidity of air	30 ~ 80 % relative (not condensing)	
Input voltage – power supply unit	110 - 230 V - 240 V AC	
Input voltage - Appliance	13.5 - 16 V	
Interfaces standard	Digital I/O, Ethernet, RS-232, USB	
Underfloor weighing device	Brackets included	
Languages User interface	German, English, French, Italian, Polish, Romanian, Spanish, Turkish, Czech, Hungarian, see chap. 8.2	

KERN	ILT 10K-5NM	ILT 35K-4NM	ILT 50K-4C
Readability (d)	0.01 g	0.1 g	0.1 g
Weighing range (max)	10 kg	35 kg	50 kg
Minimum load (Min)	0.5 g		-
Verification value (e)	0.1 g	1 g	-
Verification class	II	II	-
Reproducibility	0.01 g	0.1 g	0.2 g
Linearity	± 0.02 g	± 0.3 g	± 0.5 g
Stabilization time	4 sec.	3 sec.	3 sec.
Adjustment weight	internal		50 kg (E2 class) not included
Warm-up time	8 h	2 h	4 h
Reference quantities at piece counting	10, 20, 50, freely selectable		
Dimensions weighing platform, stainless steel	347 x 259 mm		
Net weight	19.9 kg		13.5 kg
Permissible ambient condition	+15° C to +35° C		
Humidity of air	30 ~ 80 % relative (not condensing)		
Input voltage – power supply unit	110 - 230 V - 240 V AC		
Input voltage - Appliance	13.5 - 16 V		
Interfaces standard	Digital I/O, Ethernet, RS-232, USB		
Underfloor weighing device	Brackets included		
Languages User interface	German, English, French, Italian, Polish, Romanian, Spanish, Turkish, Czech, Hungarian, see chap. 8.2		

1.1 Dimensions

Terminal:

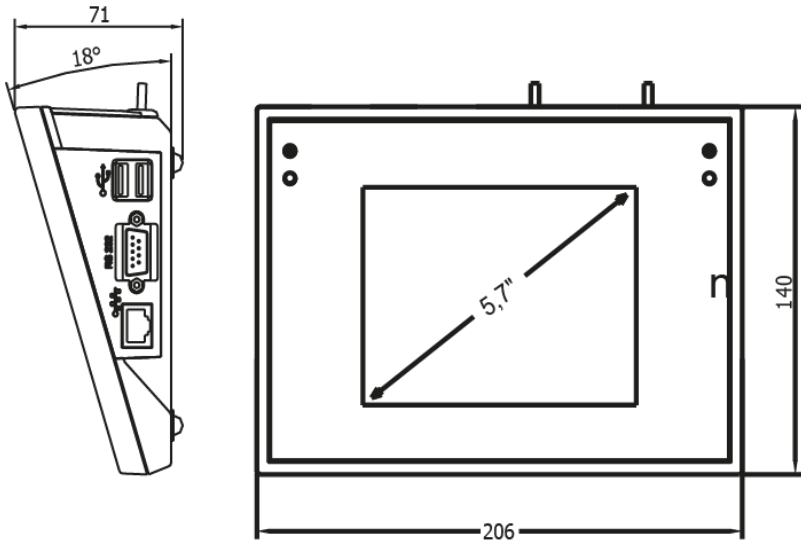

AET [d] = 0.1 mg:

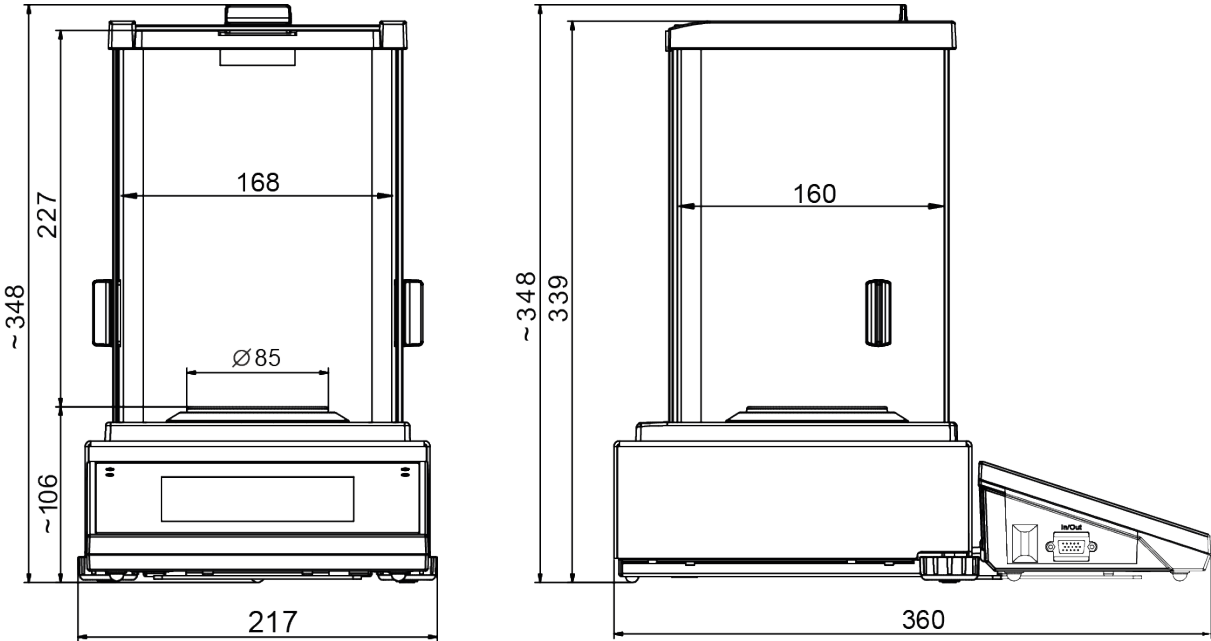

AET [d] = 0.01 mg:

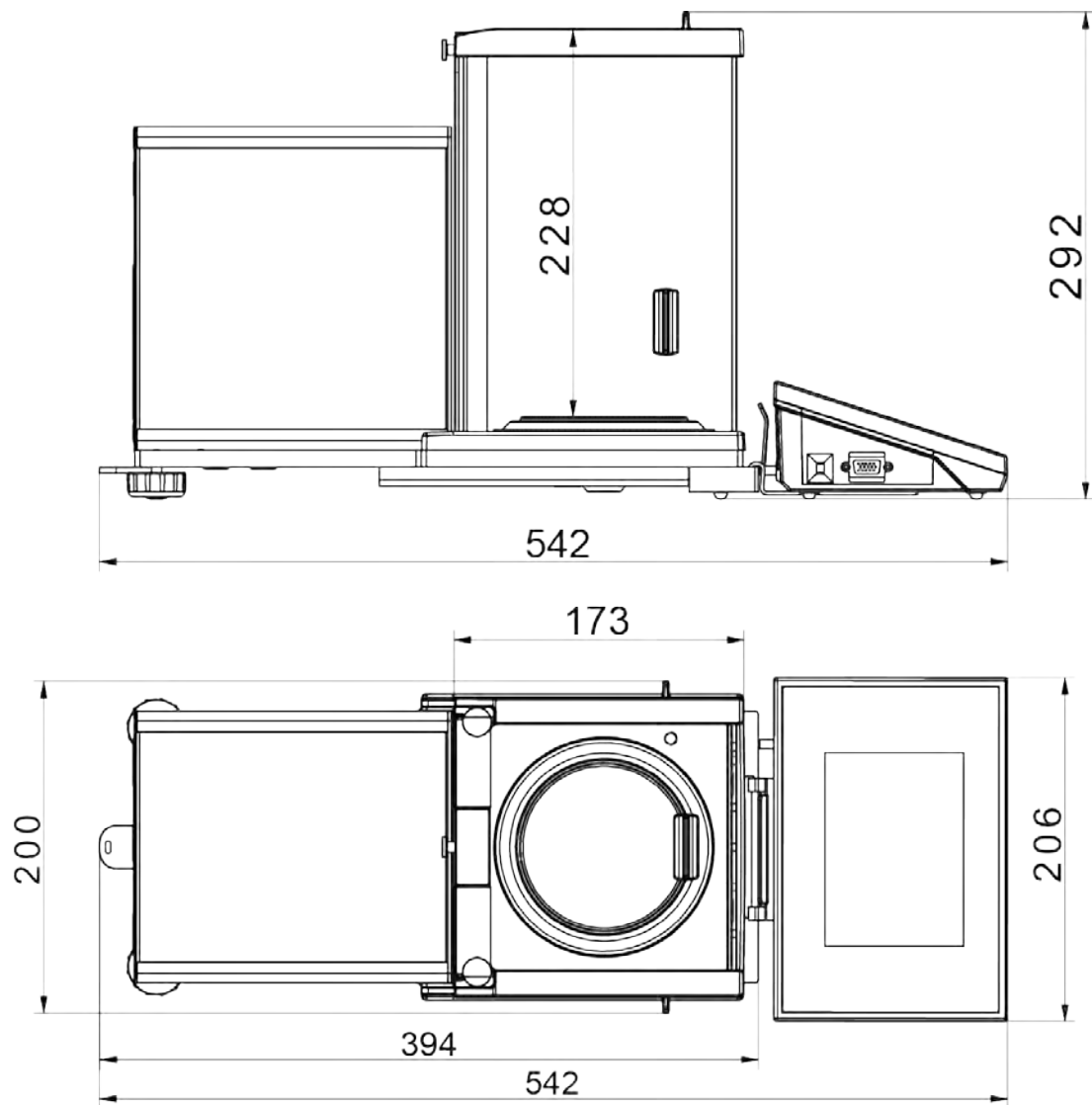

PET [d] =0.001 g:

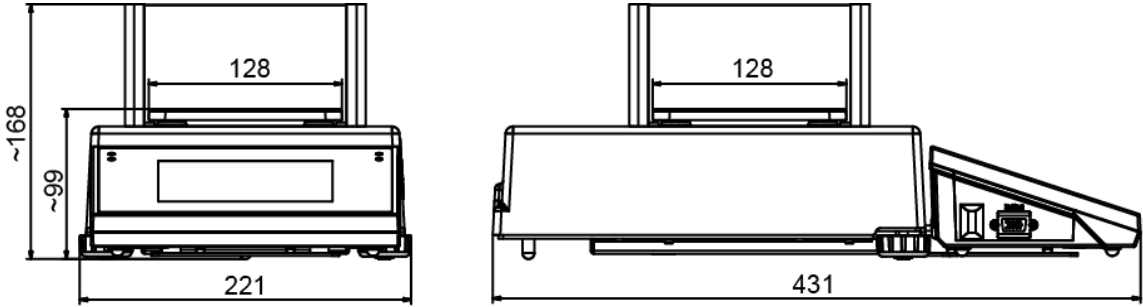

PET [d] =0.01 g:

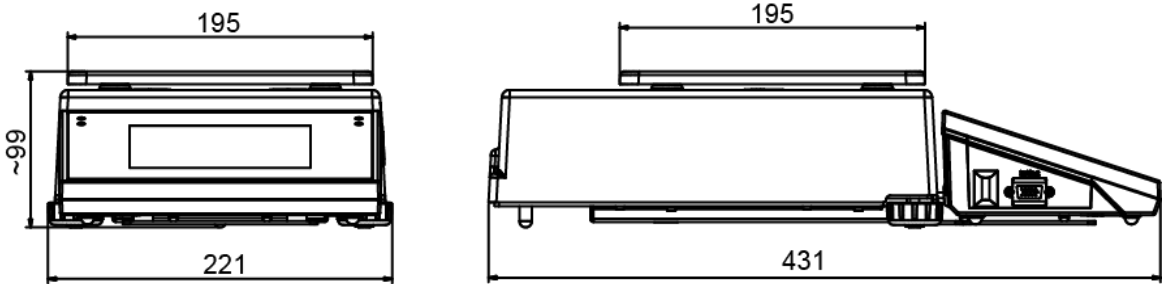

ILT:

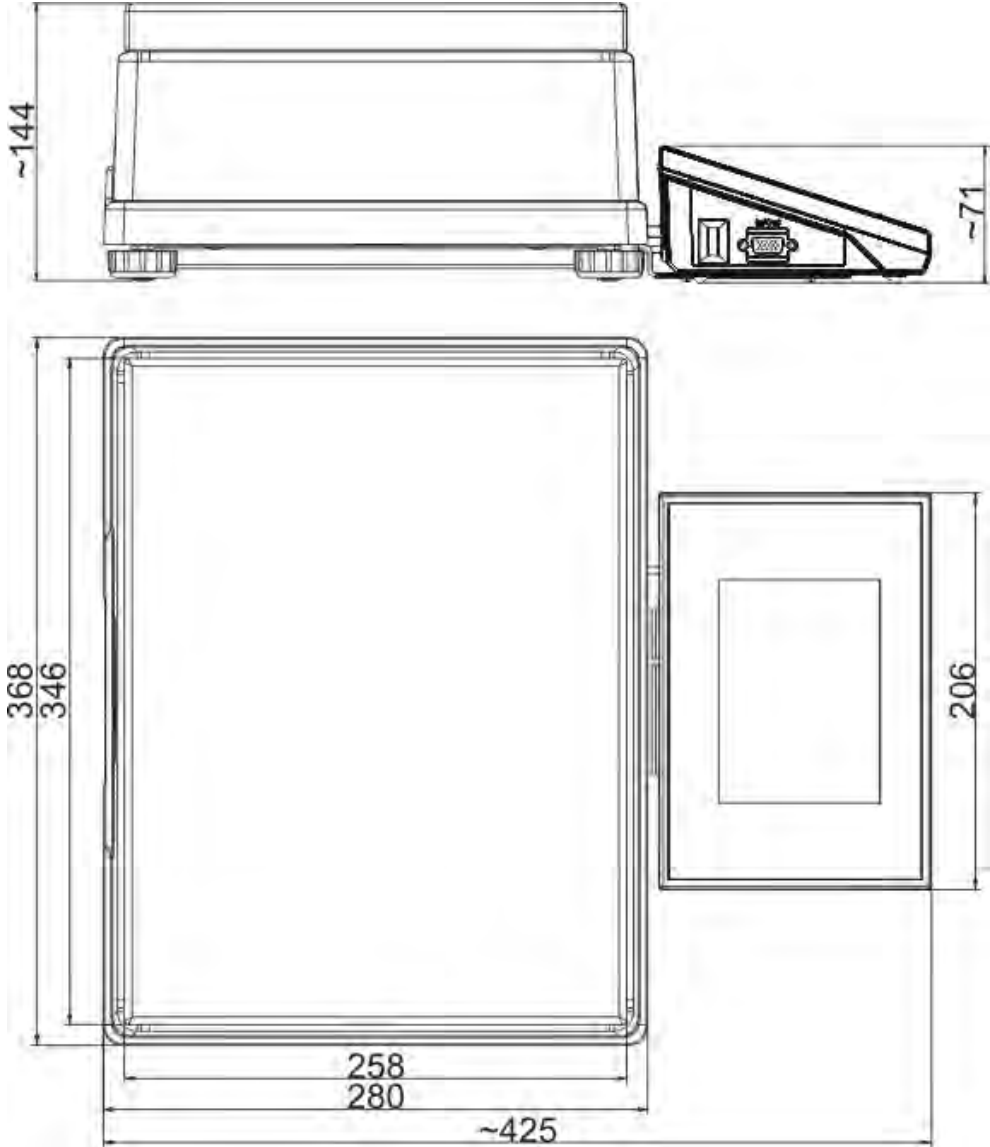

1.2 Connections / interfaces:

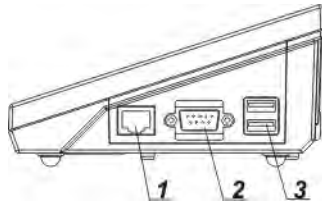

1. Ethernet
2. RS232 (COM1)
3. USB port

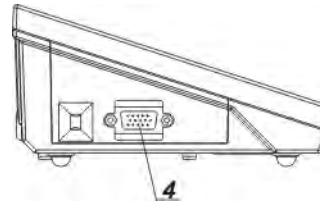

4. Digital I/O (COM2)

Pin allocation (front view)

- RS232 DB9/M (male connector, 9-pin)**

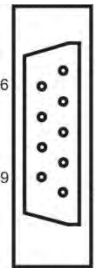

- Pin2 - RxD
- Pin3 - TxD
- Pin5 - GND

- Digital I/O, RS232 DSUB15/F (female connector, 15-pin)**

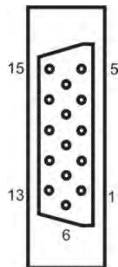

- Pin1 - GNDWE
- Pin2 - OUT1
- Pin3 - OUT2
- Pin4 - COMM
- Pin5 - 6÷9VDC
- Pin6 - IN4
- Pin7 - IN3
- Pin8 - TxD2
- Pin9 - 5VDC
- Pin10 - GNDRS
- Pin11 - IN2
- Pin12 - IN1
- Pin13 - RxD2
- Pin14 - OUT4
- Pin15 - OUT3

2 Appliance overview

AET [d] = 0.01 mg:



AET [d] = 0.1 mg:

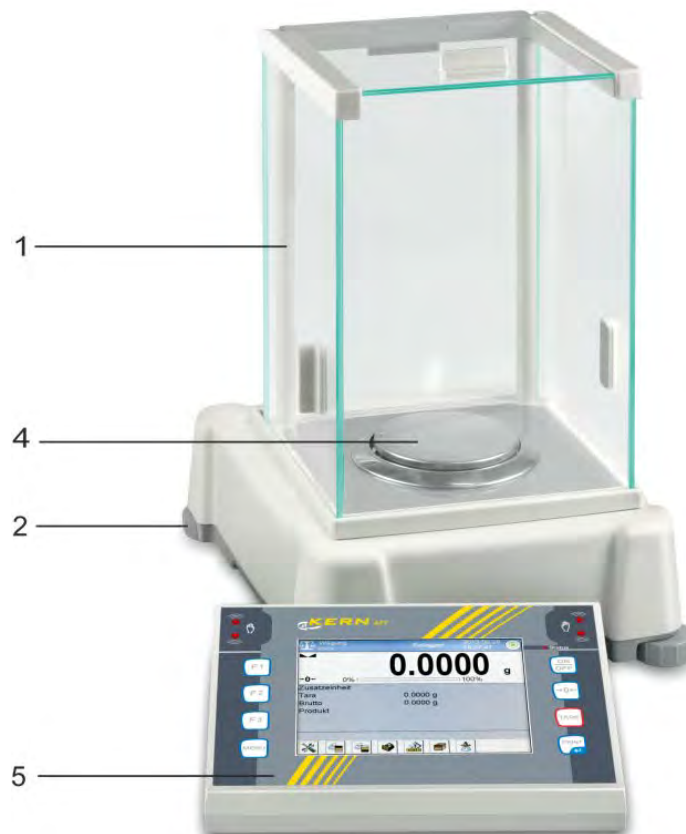

- 1 Glass wind screen
- 3 Metal draft shield
- 5 Terminal (details see chapter 3)

- 2 Levelling screw
- 4 Weighing pan

PET [d] =0.001 g:

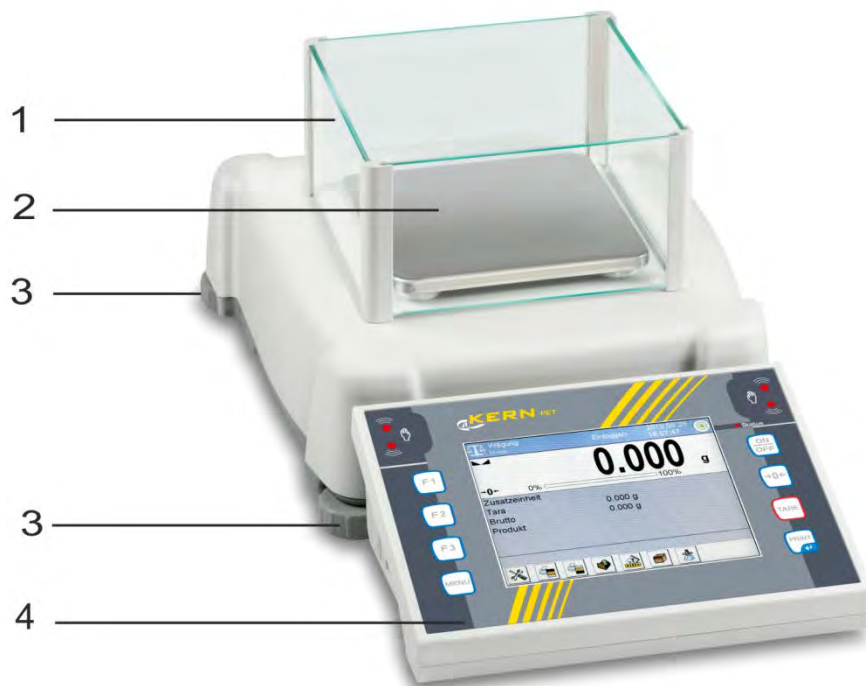

PET [d] =0.01 g:



- 1 Glass wind screen
- 3 Levelling screw

- 2 Weighing pan
- 4 Terminal (details see chapter 3)

ILT:



- 1 Weighing pan
- 3 Levelling screw

- 2 Bubble level
- 4 Terminal (details see chapter 3)

3 Operating elements

3.1 Keyboard overview



1 Non-contact sensors.

Function adjustable (such as zero setting, taring, printing) see chap. 10.2.2.

Sensitivity in menu <other → sensitivity of sensors > adjustable, see chap. 8.8.5

Execute the function by moving your hand across the respective sensor. The sensor will trigger an audio signal to confirm that it has detected the command before carrying it out. The sensor are factory-set to disabled.

2	F1	}	Short-cut configuration key for frequently repeated applications, functions and settings	Call application	Factory setting
3	F2			Call user profile	
4	F3			Start internal adjustment	
5	MENU	Call menu			
6	LED Status display	OFF: When instrument is ready for operation	ON: When weighing scale is connected to power supply	Flash ing: When the operating system is loading	
7	ON/OFF	Turn on/off			
8	→0←	Zeroing			
9	TARE	Taring			
10	PRINT	Transfer weighing data via interface			

3.2 Overview of display

The colour touch screen is a touch-sensitive display. The touch screen is not restricted to displaying information, you also can enter commands by touching certain areas of the surface.



Do not operate touch screen by using pointed or sharp objects!

This may damage the touch screen.

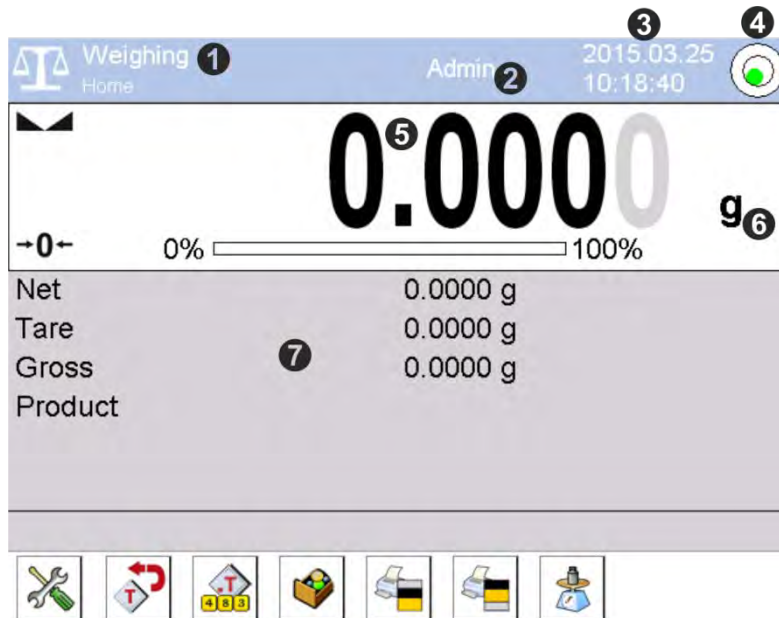

The display is divided into four areas:

1. Range



- 1 Active application.
Tapping the command button will call the menu where you can select your desired application.
- 2 Logged-in user
You can select further users by tapping the command button.
- 3 Current date/time
You can also change the date by tapping this command button.
- 4 Status of levelling
To invoke the levelling help screen, tap this command button. There you are shown in which direction to turn the levelling screws until the air bubble in the spirit level vial is in the specified circle.

2. Range



- 5 Current weighing value.
In weighing scales with type approval the non-calibrated area is presented in pale colour.
To present the weighing value in large numbers, tap this command button.
To zoom out the weighing value, tap again.
- 6 Current weighing unit
To select from the displayed menu, tap the command button.

3. Range

Net		0.0000 g
Tare		0.0000 g
Gross	7	0.0000 g
Product		

- 7 Info box
The box shows any additional information available about the enabled application.
To select which info boxes and function keys [8] you would like to select, tap this command button; see chap. 10.2.3

4. Range



- 8 Function keys
Function keys provide direct access to functions and settings frequently used for the enabled application.
For how to define function keys see chap. 0

4 Basic instructions

4.1 Proper use

The balance you purchased is intended to determine the weighing value of material to be weighed. It is intended for use as “non-automatic weighing scale”.

- Place load manually and with care onto weighing platform. Prevent loads from dropping down

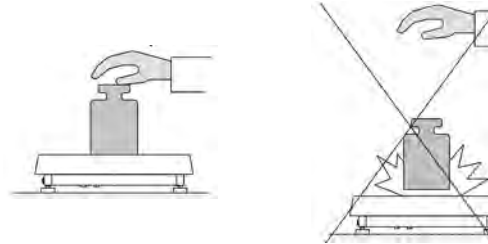

- Place load in the centre

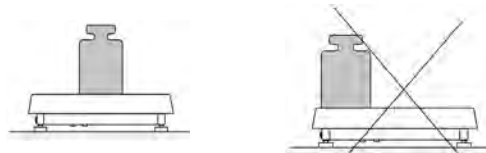

- Avoid off-centre loading as well as impacts from the side

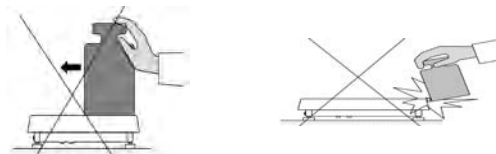

As soon as a stable weighing value is reached the weighing value can be read.

4.2 Improper Use

Do not use balance for dynamic add-on weighing procedures, if small amounts of goods to be weighed are removed or added. The “stability compensation” installed in the balance may result in displaying an incorrect measuring value! (Example: Slowly draining fluids from a container on the balance.)

Do not leave permanent load on the weighing pan. This may damage the measuring system.

Impacts and overloading exceeding the stated maximum load (max) of the balance, minus a possibly existing tare load, must be strictly avoided. Balance may be damaged by this. Never operate balance in explosive environment. The serial version is not explosion protected.

The structure of the balance may not be modified. This may lead to incorrect weighing results, safety-related faults and destruction of the balance.

The balance may only be used according to the described conditions. Other areas of use must be released by KERN in writing.

4.3 Warranty

Warranty claims shall be voided in case

- Our conditions in the operation manual are ignored
- The appliance is used outside the described uses
- The appliance is modified or opened
- Mechanical damage or damage by media, liquids, natural wear and tear
- The appliance is improperly set up or incorrectly electrically connected
- The measuring system is overloaded

4.4 Monitoring of Test Resources

In the framework of quality assurance the measuring-related properties of the balance and, if applicable, the testing weight, must be checked regularly. The responsible user must define a suitable interval as well as type and scope of this test. Information is available on KERN's home page (www.kern-sohn.com) with regard to the monitoring of balance test substances and the test weights required for this. In KERN's accredited DKD calibration laboratory test weights and balances may be calibrated (return to the national standard) fast and at moderate cost.

5 Basic Safety Precautions

5.1 Pay attention to the instructions in the Operation Manual



- Carefully read this operation manual before setup and commissioning, even if you are already familiar with KERN balances.
- All language versions contain a non-binding translation. The original German is binding.

5.2 Personnel training

The appliance may only be operated and maintained by trained personnel.

6 Transport and storage

6.1 Testing upon acceptance

When receiving the appliance, please check packaging immediately, and the appliance itself when unpacking for possible visible damage.

6.2 Packaging / return transport

- Keep all parts of the original packaging for a possibly required return.
 - Only use original packaging for returning.
- ⇒ Prior to dispatch disconnect all cables and remove loose/mobile parts.

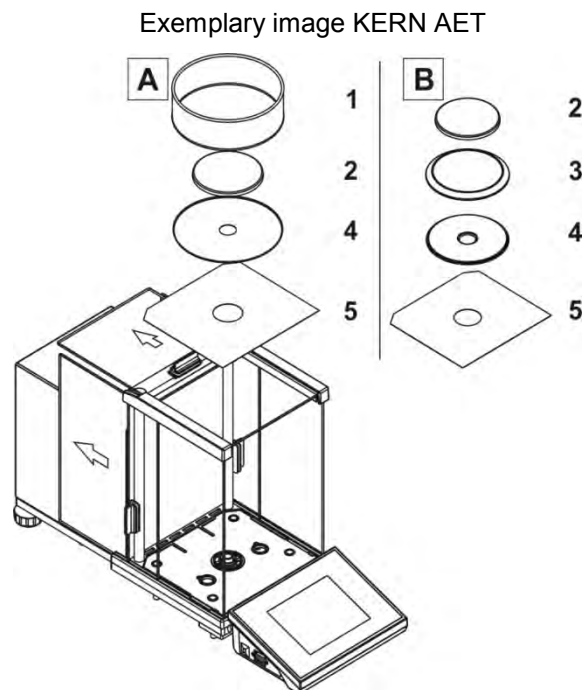

A - AET [d] = 0.01 mg | B - AET [d] = 0.1 mg

- ⇒ Reattach possibly supplied transport securing devices.
- ⇒ Pack power supply unit, weighing platform etc. in small cardboard box **[1]**.
- ⇒ Secure glass draft shield as depicted against slipping and damage



- ⇒ Fit the parts as depicted into the packaging pad.

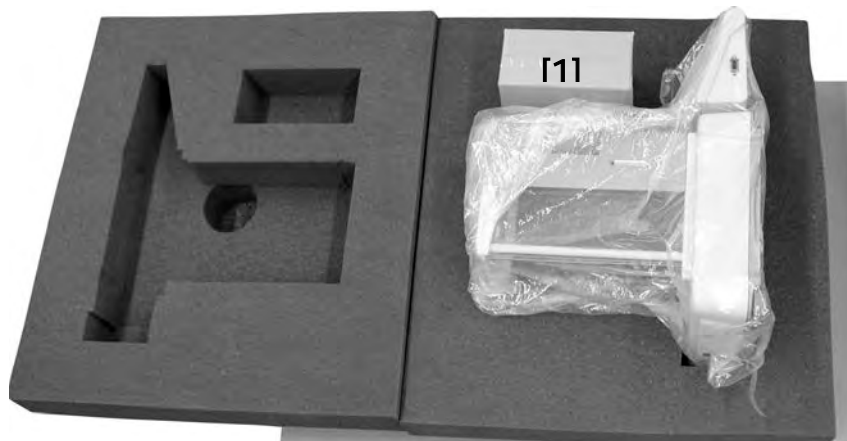

- ⇒ Place the upper packaging pad on top.



⇒ Pack as depicted and insert in shipping box.



7 Unpacking, Setup and Commissioning

7.1 Installation Site, Location of Use

The balances are designed in a way that reliable weighing results are achieved in common conditions of use.

You will work accurately and fast, if you select the right location for your balance.

Therefore, observe the following for the installation site:

- Place the balance on a firm, level surface;
- Avoid extreme heat as well as temperature fluctuation caused by installing next to a radiator or in the direct sunlight;
- Protect the balance against direct draughts due to open windows and doors;
- Avoid jarring during weighing;
- Protect the balance against high humidity, vapours and dust;
- Do not expose the device to extreme dampness for longer periods of time. Non-permitted condensation (condensation of air humidity on the appliance) may occur if a cold appliance is taken to a considerably warmer environment. In this case, acclimatize the disconnected appliance for ca. 2 hours at room temperature.
- Avoid static charge of goods to be weighed or weighing container.

If electro-magnetic fields or static charge occur, or if the power supply is unstable major deviations on the display (incorrect weighing results) are possible. In that case, the location must be changed.

7.2 Unpacking and checking

Open package, take out the appliance and accessories. Verify that there has been no damage and that all packing items are present.

7.2.1 Scope of delivery / serial accessories

- Balance, see chap. 2
- Mains adapter
- Operating manual
- Protective cover
- RS232 interface cable
- Flush-mounted hook

7.2.2 Placing

i The right place is decisive for the accuracy of the weighing results of high-resolution analytical and precision balances (see chap. 7.1).

⇒ Remove the transport locking devices [1] (models AET only)



⇒ Install weighing platform as depicted.
Assemble all parts in the right order.

Models AET

A: AET [d] = 0.01 mg | **B:** AET [d] = 0.1 mg

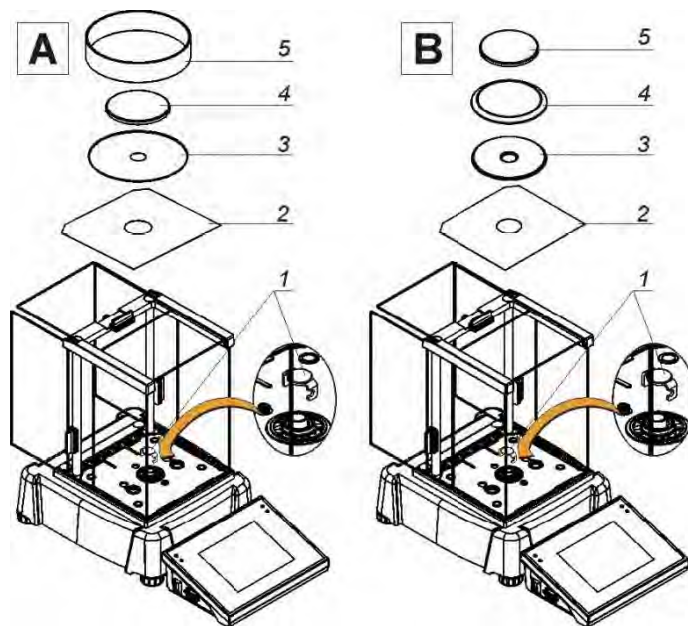

Models AET-DM

A: AET [d] = 0.01 mg | **B:** AET [d] = 0.1 mg

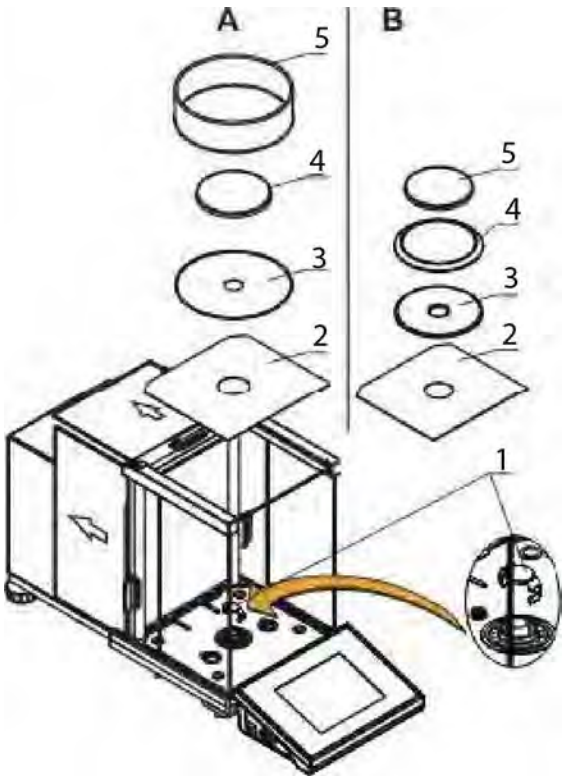

Models PET

A: PET [d] =0.001 g | **B:** PET [d] =0.01 g

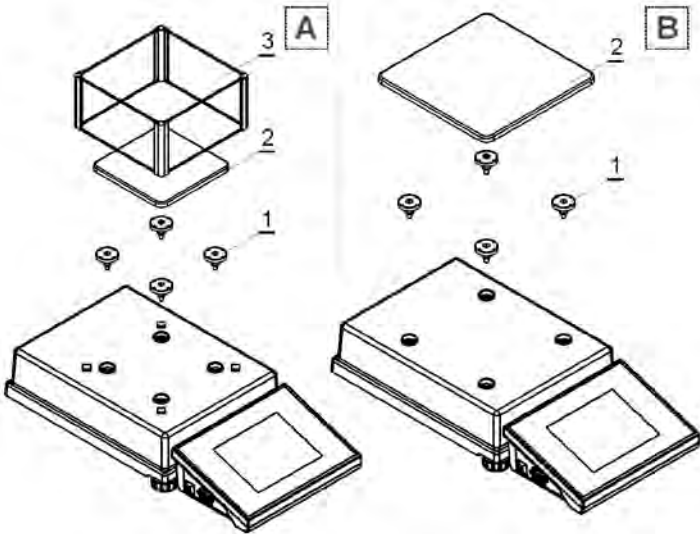

Models ILT_NM

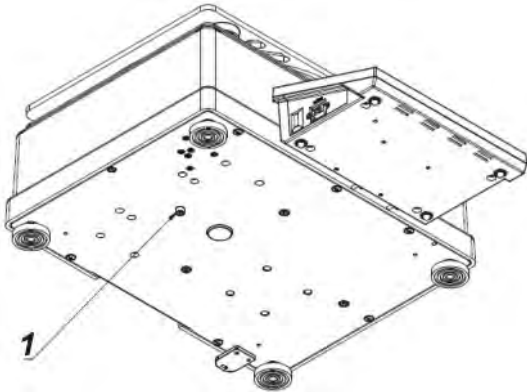

Remove transport locking screw [1]

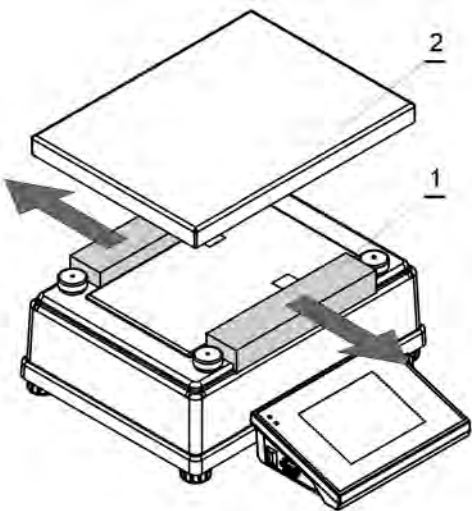

Remove transport locking devices [1] and [2]

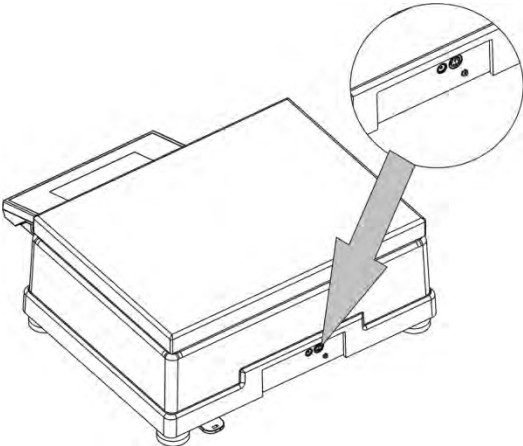

Mains adapter connection



The terminal is not mounted rigidly on the weighing scale. If required, the terminal may be placed separately anywhere in the vicinity of the weighing scale but not further away than this is permitted by the length of the cable.



7.3 Mains connection

Power is supplied via the external mains adapter. The stated voltage value must be the same as the local voltage.

Only use original KERN mains adapters. Using other makes requires consent by KERN.

7.4 Commissioning

Connect scale to power supply.

⇒ Supply balance with power via the mains adapter. The red status display is illuminated on the terminal. The motor noise of the loading system for the internal adjustment weight is audible.

⇒ Press , when the red status display starts flashing whereupon the operating system will be loading. The start screen will appear, followed by the interface. The weighing scale will carry out a self-test, followed by automatic internal adjustment.



⇒ As soon as the weight display appears, the balance is ready for weighing. Upon delivery, the weighing scale will be in a logged off state, i.e. merely simple functions such as weighing or taring will be available for use; see chap. 7.6.

To achieve full access to user parameters and editing of databases, the user must log in as administrator as described below.

i Later on the most recently used user profile will be used upon start-up.

 **Login**

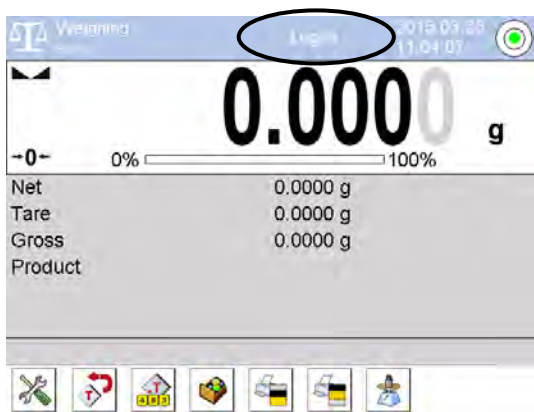

Tap the command button **<Log in>**.



The **<Operators>** window will appear.

The weighing scale will be supplied without user profile. To set preferences, the user has to log in as administrator.

Tap the **<Admin>** command button.

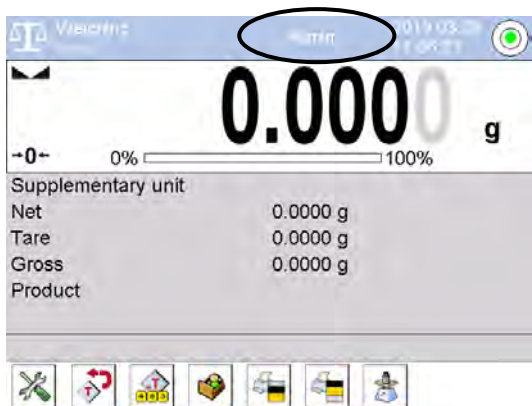

As administrator you can create additional user profiles with specific settings and user rights by going to the **<Operators>** menu; see chap. 8.2

👉 Levelling

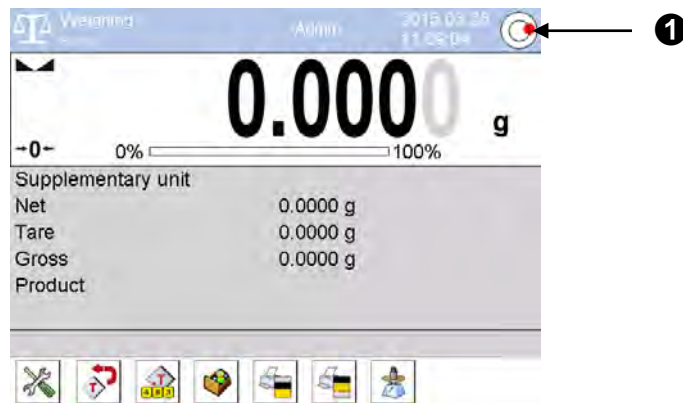

⇒ If the air bubble in the spirit level vial is not in the specified circle [1], you will have to level the weighing scale.

The weighing scale is fitted with an electronic spirit level vial that monitors correct horizontal alignment at all times. In the top right corner of the display you will find information about the status of levelling.

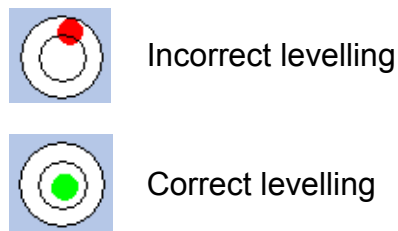

How to perform levelling:

⇒ Tap the command button in the top right corner of the display [1] and follow the instructions on the screen.

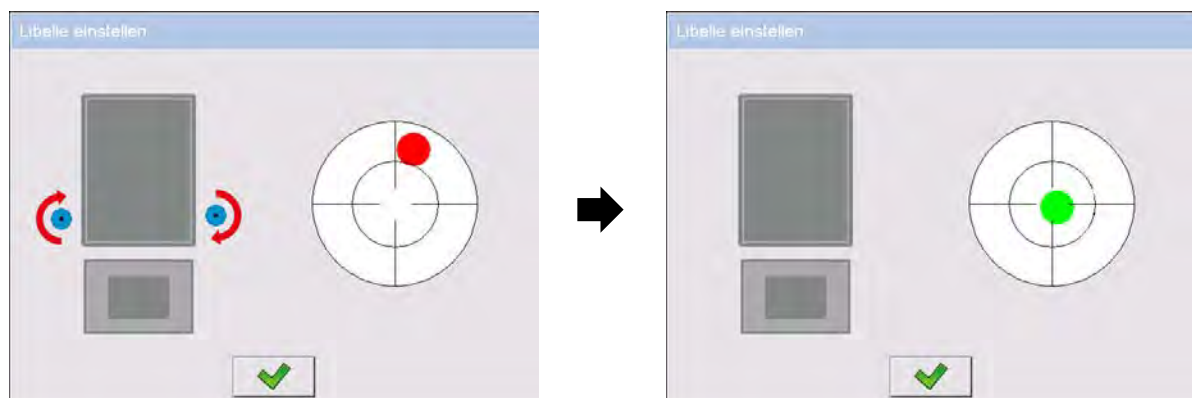

⇒ Use the levelling screws to align the weighing scale as shown until the air bubble in the spirit level vial is in the specified circle

How to set user language

German is set as the display's language upon delivery. For setting additional languages, see chap. 8.2.

i Initial Commissioning

In order to obtain exact results with the electronic balances, your balance must have reached the operating temperature (see warming up time chap. 1).

During this warming up time the balance must be connected to the power supply (mains, accumulator or battery).

To adapt to ambient conditions, open wind screen doors if necessary.

The accuracy of the balance depends on the local acceleration of gravity. Strictly observe hints in chapter Adjustment.

7.5 Shutting down / standby mode

⇒  Press and tap desired selection.

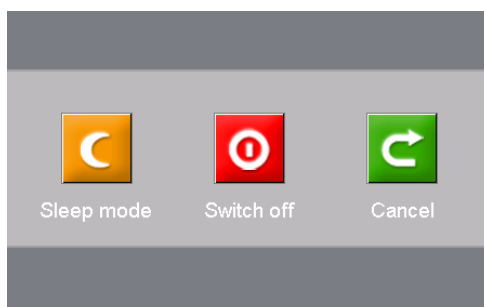

When **<Sleep>** is selected, the weighing scale will be ready for operation. It will be ready for operation immediately after start-up without requiring any warming-up time.



When **<Switch off>** is selected, the weighing scale will have to be restarted as described in chap. 7.4 and you will have to observe the required warming-up time.

7.6 Basic Operation



- ☞ A warm-up time is required for stabilisation (see chap. 1).
- ☞ For further information about specific setting options of the weighing application please see chap. 0

7.6.1 Simple weighing

- ⇒ Check zero display [$\rightarrow 0 \leftarrow$] and set to zero by  if required.
- ⇒ Position the load and close the draft shield doors if open.
- ⇒ Wait until the stability display appears (.
- ⇒ Read weighing result.

After pressing  you can save the weighing value and print it if an optional printer is connected.

7.6.2 Zeroing

In order to obtain optimal weighing results, reset to zero the balance before weighing. Zero setting is restricted to the range of $\pm 2\%$ max. For values greater than $\pm 2\%$ max error message "Err2" will appear.

- ⇒ Unload the balance
- ⇒ Press , zero display as well as indicator $\rightarrow 0 \leftarrow$ will appear.

7.6.3 How to select a weighing unit

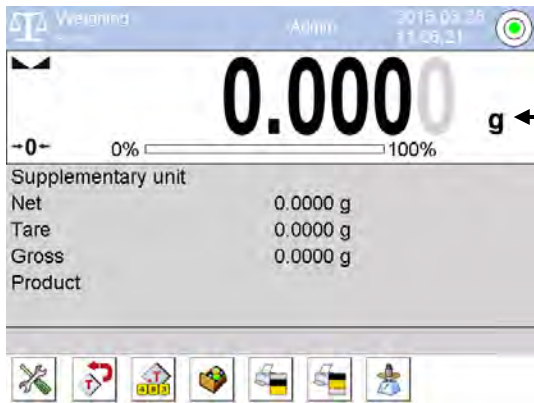

← To select from the displayed list, tap a unit.





The list of available weighing units depends on the model and calibration of the weighing scale. For non-calibrated weighing scales all weighing units are available.

Unit	Designation	Verified models:	Non verified models
Gram	[g]	yes	yes
Milligram	[mg]	yes	yes
Kilogram	[kg]	yes	yes
Carat	[ct]	yes	yes
Pound	[lb]	no	yes
Ounce	[oz]	no	yes
Unze troy	[ozt]	no	yes
pennyweight	[dwt]	no	yes
Taele Hongkong	[tlh]	no	yes
Taele Singapur	[tls]	no	yes
Taele Tajwan	[tlt]	no	yes
Taele Chiny	[tlc]	no	yes
Momme	[mom]	no	yes
Grain	[gr]	no	yes
Newton	[N]	no	yes
Tical	[ti]	no	yes

7.6.4 Weighing with tare

➤ Taring



The dead weight of any weighing container may be tared away by pressing a button, so that the following weighing procedures show the net weight of the goods to be weighed.

- ⇒ Put weighing container on weighing plate and close the wind screen doors.
- ⇒ Wait until the stability display appears () , then press . Zero display and indicator (**Net**) appear. The weight of the container is now internally saved.
- ⇒ Weigh initial load and close the draft shield doors, if open.
- ⇒ Wait until the stability display appears () .
- ⇒ Read net weight.







- You can assign the tare weight to a product in the database. When this product is selected, its tare weight will be loaded automatically.
- When the balance is unloaded the saved taring value is displayed with negative sign.
- Do not tare negative values! Attempts of taring negative values will result in error message “Err 3”.
- The taring process can be repeated any number of times. The limit is reached when the whole weighing range is exhausted.

➤ Numeric entering of tare weight

- ⇒ Press the function key  to display the numerical input window.
- ⇒ Enter known tare weight and confirm by pressing . The display returns to weighing mode.
The entered weight will be saved as tare weight and indicator (**Net**) and the tare weight will be shown with minus sign.
- ⇒ Position the filled weighing container.
- ⇒ Wait until the stability display appears () .
- ⇒ Read net weight.

➤ Delete tare

1. Unload weighing plate and press .
The **(Net)** indicator turns off, the zero display appears.
2. Pressing  when the weighing plate is loaded, is restricted to zero setting range 2% max. (>2% max. triggers error message "Err 2").
The **(Net)** indicator turns off, the zero display appears.
3. With the weighing platform loaded or unloaded (<2% Max.) press the <Switch off tare> function key  (configuration of function key see chap. 0.)
The **(Net)** indicator turns off, the zero display appears.
If a function key is configured as <restore tare>  the most recently used tare value will be recalled (configuration of function key see chap. 0).

7.7 Connection of peripheral devices

Before connecting or disconnecting of additional devices (printer, PC) to the data interface, always disconnect the balance from the power supply.

With your balance, only use accessories and peripheral devices by KERN, as they are ideally tuned to your balance.

8 System settings (menu)



The system settings allow you to adapt the behaviour of the weighing scale to your requirements (such as ambient conditions, special weighing processes).













- The system settings apply to all user profiles and applications.
- For any change of settings the user must be logged in as **<Administrator>**.
- Not all settings are available for weighing scales with type approval.

Activating system settings (menu)

To open system settings press  or  and the options for system settings will be displayed.



















Menu overview

System settings are sub-divided into the following menu blocks:

 <p>ADJUSTMENT see chap. 8.1</p>	 <p>USER see chap. 8.2</p>	 <p>PROFILES see chap. 8.4</p>
 <p>DATA BASES see chap. 20</p>	 <p>COMMUNICATION see chap 8.5.</p>	 <p>DEVICES see chap. 8.6</p>
 <p>INPUTS / OUTPUTS see chap. 8.7</p>	 <p>AUTHORISATIONS see chap. 8.3</p>	 <p>OTHERS see chap. 8.8</p>
 <p>ENVIRONMENT see chap. 8.9</p>	 <p>UPDATE Not documented</p>	 <p>INFORMATION ON SYSTEM see chap. 8.10</p>

To call and change individual settings tap the icons.

Navigation in the menu

 or 	Call up menu
	Scroll down
	Scroll up
	Scroll "from top to bottom".
	Confirm entry, back to last view
	Cancel entry, back to last view
	Add item to database
	Search for date in database
	Search for name in database
	Search for code in database
	Print item from database
	Delete editing field
	Hide/show keyboard
	Retrieve data from USB storage medium
	Show selection list for all available variables
	Display goes back one level to last view
	Display goes back directly to start screen

Exit menu / back to weighing mode.

Press , display will go back one level to last view.

Back to start screen, press  **repeatedly**,

or

⇒ In the top bar press  **once**, the device will return immediately to the start screen.

All changes entered will be saved automatically after returning to the last view or start screen.



8.1 Adjustment

As the acceleration value due to gravity is not the same at every location on earth, each balance must be coordinated - in compliance with the underlying physical weighing principle - to the existing acceleration due to gravity at its place of location (only if the balance has not already been adjusted to the location in the factory). This adjustment process must be carried out for the first commissioning, after each change of location as well as in case of fluctuating environment temperature. To receive accurate measuring values it is also recommended to adjust the balance periodically in weighing operation.



- The internal adjustment weight is available at all times for starting adjustment via keyboard stroke.

The weighing scales are set by the factory in such a way that adjustments based on time or temperature control are carried out automatically.

The moment a change in temperature is detected this function uses the internal tare weight to carry out fully-automatic adjustment with the help of a temperature sensor.

In weighing scales with type approval adjustment takes place automatically in weighing mode under the conditions below [Parameter (1) and (2) can only be changed in the service menu, a process that results in loss of validity for the calibration]. In weighing scales without type approval parameter (1) and (2) can be adjusted in the menu; see chap. 8.1.5 **<Automatic adjustment>**.

(1) When there is a change in ambient temperature (Δt 2°C)

(2) When about four hours has passed since the previous adjustment.

(3) When the weighing scale is switched from standby status to weighing mode.

- Observe stable environmental conditions. A warming up time (see chapter 1) is required for stabilization.
- Ensure that there are no objects on the weighing pan.

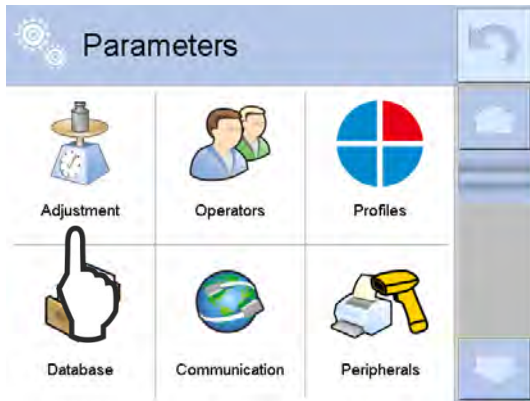

Tap <Adjustment>.

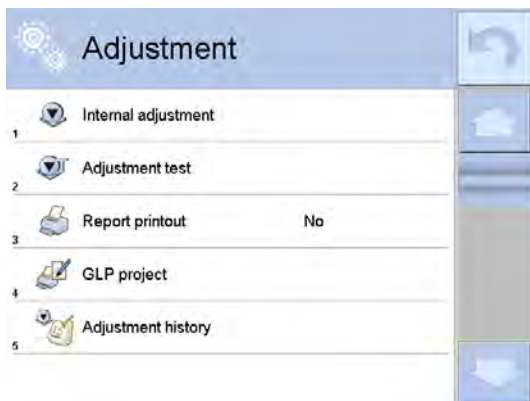

Display example for weighing scales with type approval

The selection list will appear.

Selection list for weighing scales with type approval:

- Internal adjustment
- Adjustment test
- Print receipt (report)
- GLP draft
- Adjustment history

Selection list for weighing scales without type approval:

- Internal adjustment
- External adjustment
- User adjustment
- Adjustment test
- Automatic adjustment
- Time automatic Adjustment
- Print receipt (report)
- GLP draft
- Adjustment history

8.1.1 Internal adjustment (Not available for ILT 50K-4C)



Tap <Internal Adjustment>.

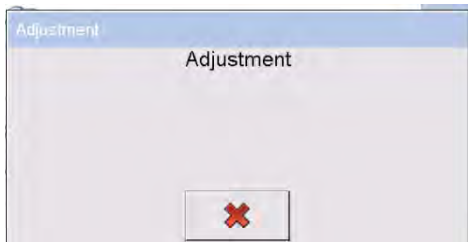

The adjustment process is started.



Back to menu after successful adjustment with .

Return to weighing mode using



i Where an optional printer is connected and the setting <print receipt yes> selected an adjustment report will be printed automatically.

Printout example KERN YKB-01N:

-----Adjustment internal -----	
Date	2014.06.05
Time	08:55.12
Balance type	PET
Balance ID	132012
Operator	Admin
Difference	0.002
Temperature	20 °C

Signature	-----
.....	

8.1.2 External adjustment (For weighing scales without type approval only)

Provide required adjustment weight; see chap. 1.

The adjustment weight to be used depends on the capacity of the weighing scale. Carry out adjustment as closely as possible to the maximum load. Info about test weights can be found on the Internet at: <http://www.kern-sohn.com>

In the selection list

tap **<External Adjustment>**



Ensure that there are no objects on the weighing plate.

Tap , **<Determine starting weight>** will be displayed.

Wait until the weighed value for the required adjustment weight appears.

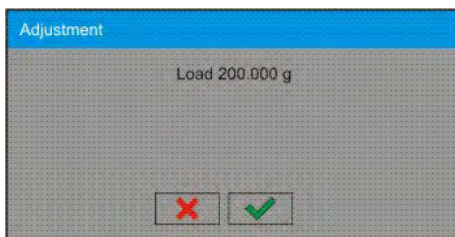

Place the displayed adjustment weight carefully in the centre of the weighing platform. Close draft shield doors completely, as required.

Acknowledge with .

Upon display of **<Remove load from weighing pan>** remove the adjustment weight and close the draft shield doors, as required.

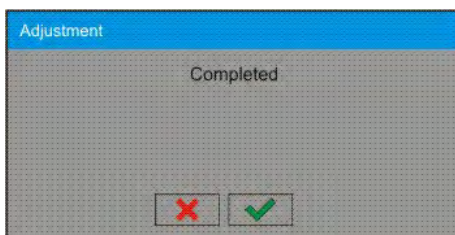

Wait until display **<zero>** followed by **<finished>** appears.

Take away adjustment weight.

Return to menu by .

Return to weighing mode using .

8.1.3 User adjustment (Weighing scales without type approval only)

The user adjustment function is used for the adjustment of the weighing scale based on a weight (0.15 max – max) defined by the user.

- Tap < **User adjustment** > in the selection list.
- Enter a value defined by the user in the displayed input window and apply by



When the message “Load on platform (weighing pan) appears, make sure that there are no objects on the weighing platform.

- Tap  <Determine initial weight> and zero will appear.
- Wait until the weight value of the defined adjustment weight is displayed.
- Place the displayed adjustment weight carefully in the centre of the weighing platform.

Close draft shield doors, as required. Acknowledge with .

- When the message <Remove load from weighing pan weighing platform> appears, remove the adjustment weight and close the draft shield doors, as required.
- Wait until the message “zero setting”, followed by “finished”, appears.

- Return to menu by .

- Return to weighing mode using .

8.1.4 Adjustment test

This function is applied to compare the internal adjustment weight with the saved value. The test is carried out automatically. The result will be shown on the display and, where an optional printer is connected and the setting <print receipt yes> set will be printed via the RS 232 interface.

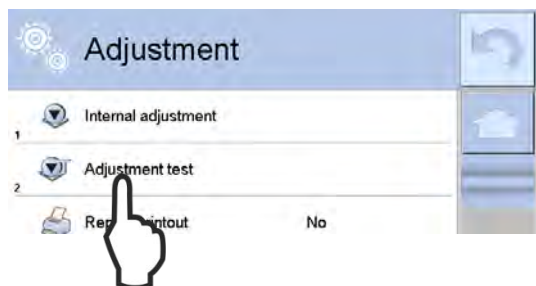

Tap <Adjustment Test> in the selection list.

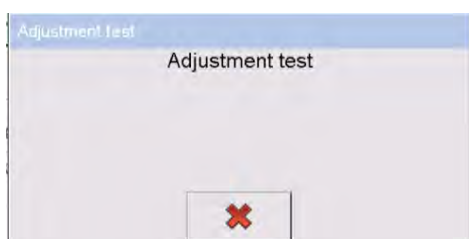

Adjustment test is started

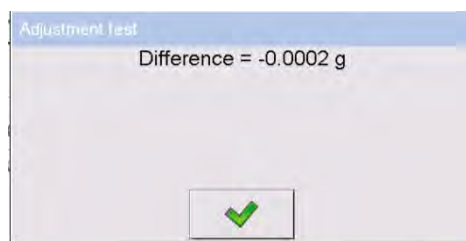

After the adjustment test go back to menu by .

Return to weighing mode using .

8.1.5 Automatic adjustment (For weighing scales without type approval only)

This function is used to define the parameters for automatic adjustment.

⇒ Tap < **Automatic adjustment** > in the selection list.

The available parameters will appear on the screen:

- **None** Automatic adjustment disabled
- **Time** Time controlled automatic adjustment.
Enter the time period after which automatic adjustment is to be started. See chapter below >time automatic adjustment
- **Temperature** Automatic adjustment only upon change of temperature
- **Both** Automatic adjustments are time and temperature controlled.

1. Automatic adjustment time (For weighing scales without type approval only)

This function is used to define the time period after which automatic adjustment must start.

⇒ Tap < **Automatic adjustment time** > in the selection list.

Tap time of your choice, available for selection 1 – 12 h.

8.1.6 Adjustment log

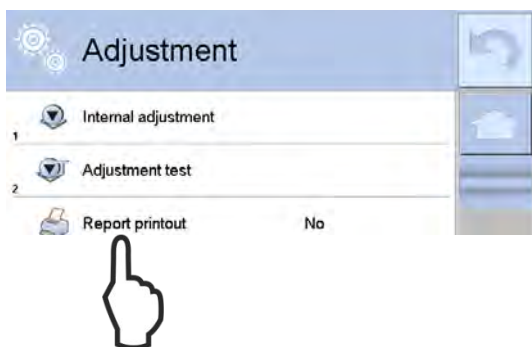

Tap <**Report printout**> in the selection list.



When <**Yes**> is set, an adjustment report will be printed automatically after the adjustment / adjustment test, provided an optional printer is connected.

8.1.7 GLP draft

Quality assurance systems require logs of weighing results as well as of correct adjustment of the balance stating date and time and balance identification. The easiest way is to have a printer connected.

This function is used to determine the content for the data output. All parameters set to “**Yes**“ will be issued.

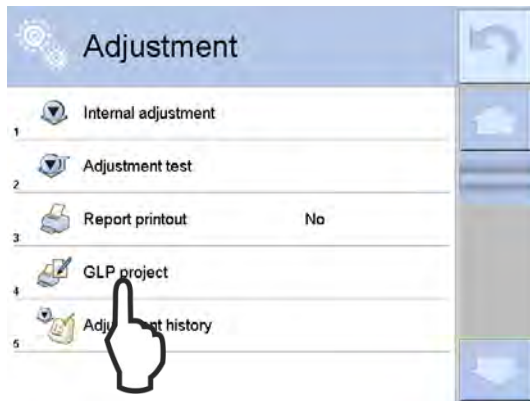

Tap < **GLP project** >.



The selection list will appear.

All parameters set to “**Yes**“ will be issued.

2. Adjustment history

The weighing scale draws and saves all adjustment dates and test results carried out. As soon as the memory is full, the oldest data will be deleted and overwritten by the new ones.

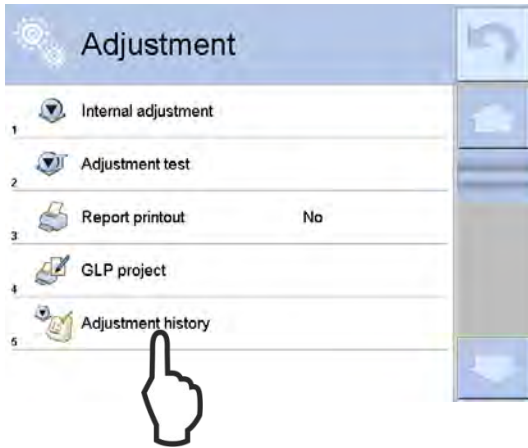

Tap **< Adjustment history >**.

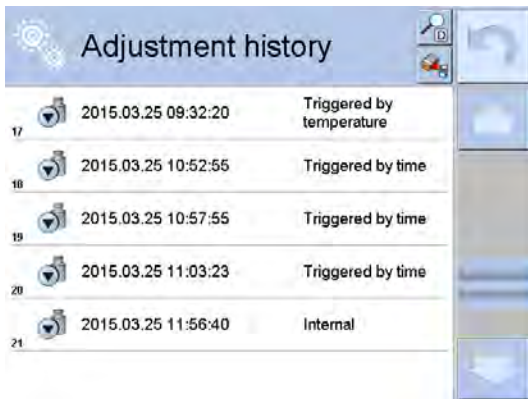

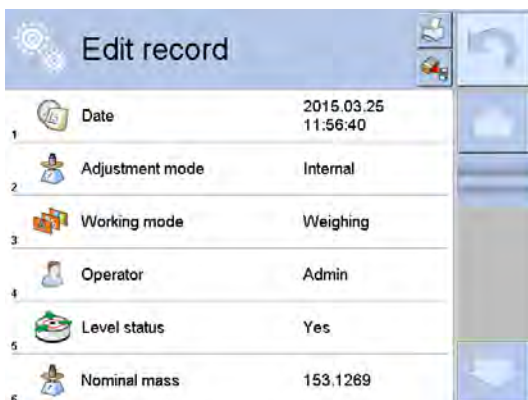

The list of executed adjustments will appear.

Press  to search for the date of the adjustment.



Select data record and all specific data for adjustment will be shown.

Press  to print the adjustment report.

Press  to export data with the help of an USB storage medium.



8.2 User

This function provides the following options for settings:

- Create new user profile (authorisation restricted to administrator)
- Edit, copy or delete user profiles

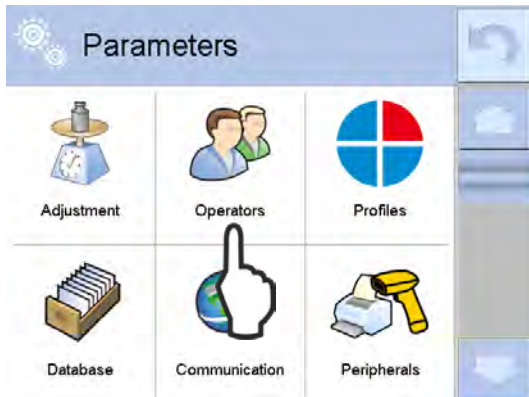

Tap <Operators>.



The user menu will appear.

Tab. 1:

Authorisation level	Available rights and functions
Administrator	<p>The administrator is authorised to use all functions and has all rights of access.</p> <p>There is only one administrator.</p>
Advanced user	<ul style="list-style-type: none"> ⇒ Start and carry out weighing processes. ⇒ Delete old data from the database ⇒ Access to the following functions: <ul style="list-style-type: none"> <Operating modes> <Profile ➔ Readout> <Communication> <Devices> <Other> except <Date / Time>
User	<ul style="list-style-type: none"> ⇒ Start and carry out weighing processes. ⇒ Define universal variables ⇒ Export weighing data ⇒ View data from the database ⇒ Access to the following functions: <ul style="list-style-type: none"> <Profile ➔ Readout> <Other> except <Date / Time>
Guest	<ul style="list-style-type: none"> ⇒ Carry out weighing processes. ⇒ No access to menu or database.



Activating users

The name of the user is displayed at the top of the display during operation. To display the user menu, tap this command button.

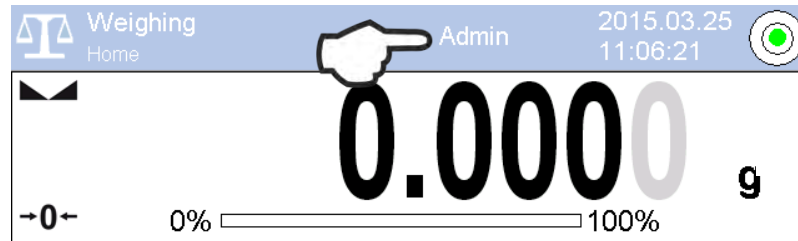

Select user from the list.

If the user is password-protected, enter password and confirm by



The display will change to operating mode, the selected user will be called and shown at the top of the display.

8.2.2 Editing user data



Tap the user data to be changed



Select and change the setting

8.2.3 Copying deleting and editing user data



Press and hold button for user name.

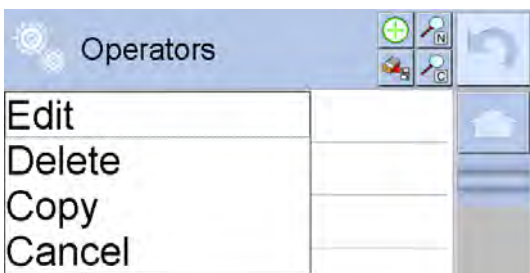

Select option:

- **Edit**
- **Delete**
- **Copy**
- **Cancel**



8.3 Authorisations

i The **<Authorisations >** function will only be available if you have logged in as **<Administrator>**.

This function is used by the administrator to change the settings for user rights (See chap. 8.2.1/ Tab. 1) and to assign rights to a logged-in operator of the weighing scales „Anonymous user“).

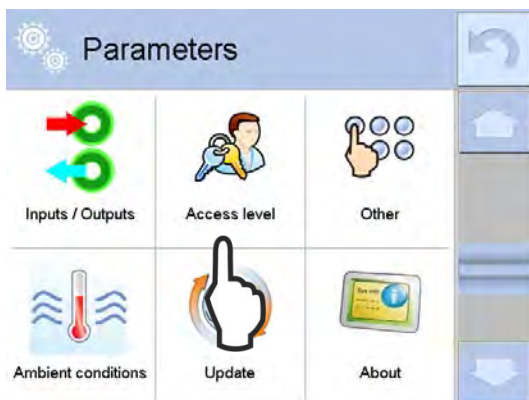

Tap **<Access level>**.



1. Anonymous user

This function is used to assign rights to an operator of the weighing scale who is not logged-in.



Tap **<Anonymous operator>**

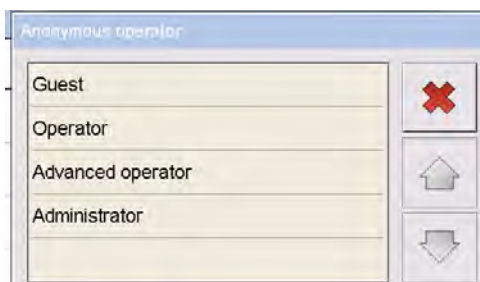

The selection list will appear.

For available rights and functions of each option see chap. 8.2.1 / Tab. 1.



2. Date and time

This function is used to allow the user access to <Date and time>



Tap < **Date and time** >

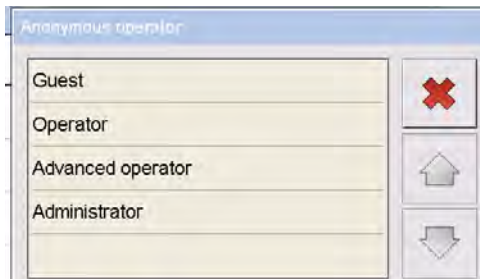

The selection list will appear.

Select the user to be assigned right of access.



3. Printouts

This function is used to assign the user the right to define reports (See chap.10.2.4).



Tap < **Printouts** >

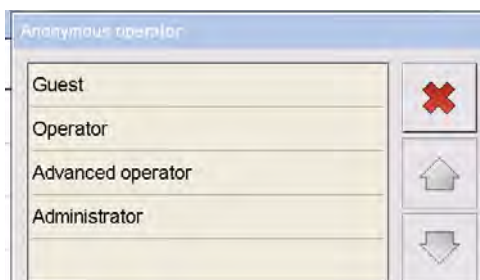

The selection list will appear.

Select the user to be assigned right of access.



4. Database

This function is used to define which functions the user has access to in the database.



Tap **<Database>**



The selection list will appear.

Select the database to which the right of access is to be assigned.



8.4 Profiles

8.4.1 Create new profile (authorisation restricted to administrator)

The default profile is named **<Home>**.

There are two changing options:

- Copy existing default profile and then modify
- Add new profile

1. Copy existing default profile

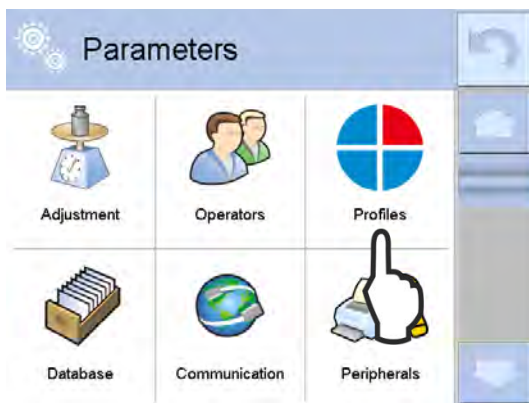

Tap **<Profiles>**.



Press and hold name of profile to be copied.



Select **<Copy>** option

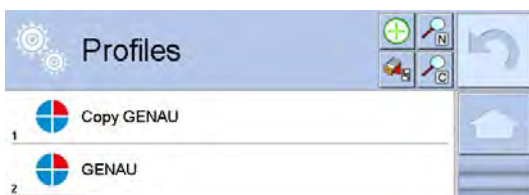

A copy of "Name" will be created and all settings applied by the basic profile.

For further settings see chap. 8.4.2

2. Add new profile

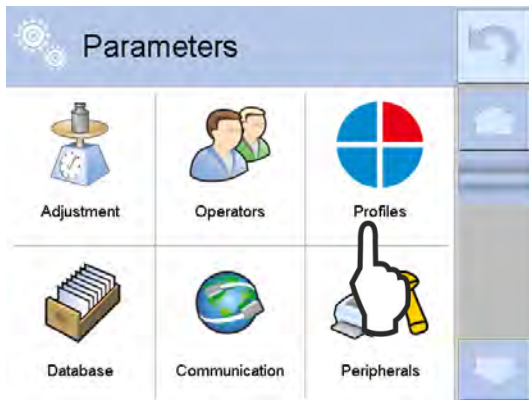

Tap <Profiles>.



Tap .
Further settings see chap. 8.4.2

3. Delete profile

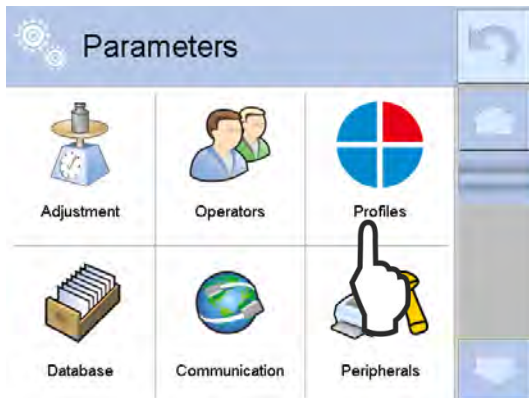

Tap <Profile>.

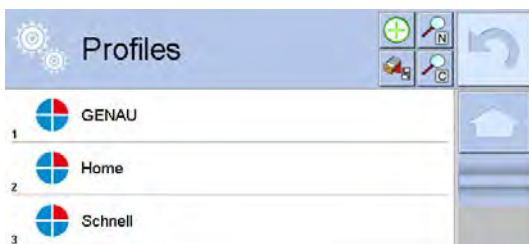

Press and hold the name of the profile to be deleted.



Select <Delete> option.
Confirm query <Confirm to delete> by



8.4.2 Defining profile



- ⇒ Administrator rights required
- ⇒ Ensure that the profile to be changed is enabled.



Tap profile to be changed such as <Copy Home>.

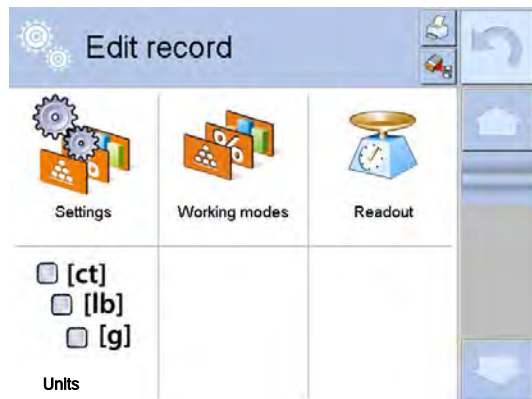

The following records will be shown.

- Settings
- Applications
- Weighing parameter
- Weighing Units

To call and change individual settings tap the icons.



1. Settings

This is where the name and default working mode (operating mode loaded as starting mode after selecting a profile) are defined.



Tap <Name>.

The numerical input window will appear.

Enter name for default profile and

confirm by .



Tap <Default working mode>.

The available modes will be displayed and applied by tapping.

When <none> is selected, the weighing scale will remain in the most recently used mode.



2. Applications

This function provides the following settings for every application selected:

- Additional settings for the application
- Function keys
- Information texts
- Define report

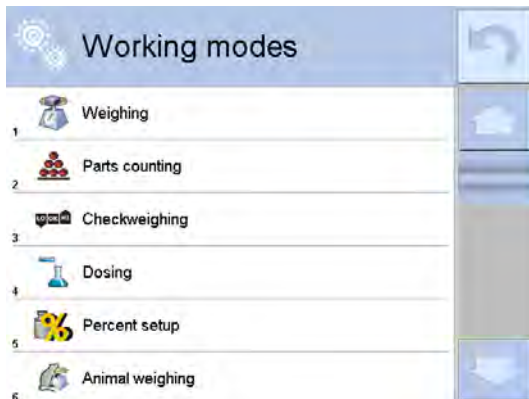

Select application from menu

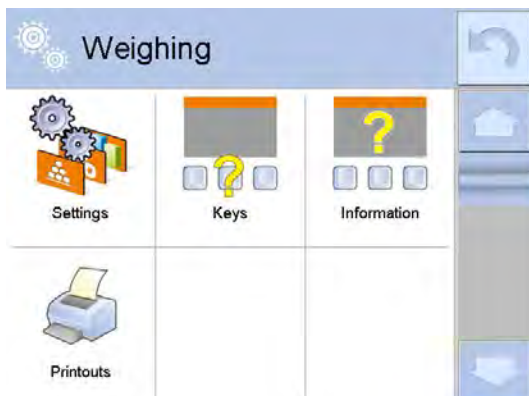

The available settings will be displayed. To call and change individual settings tap the icons.

- Settings, see chap. 10.2.1
- Function keys, see chap. 10.2.2
- Information texts, see chap. 10.2.3
- Defining report, see chap. 10.2.4

Return to menu by . Call the next application for changing application related settings.



3. Determining weighing parameters

This function is used to adapt the behaviour of the weighing scale to ambient conditions or specific requirements.

- Filter
- Confirming results
- Autozero
- Autozero: Dosing
- Last digit
- Environment

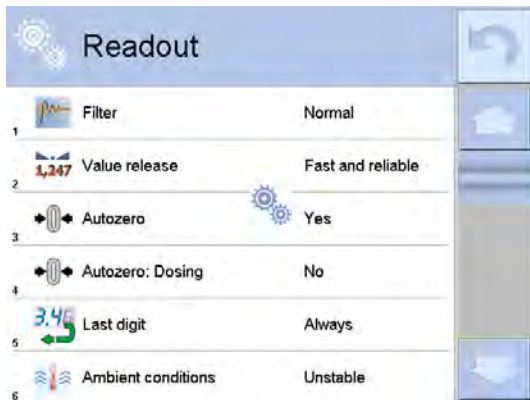

To call up and change individual settings tap the icons.

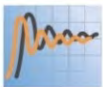

Filter

This setting is used to adapt the behaviour to ambient conditions.



Tap **<Filter>**

The selection list will appear.

We recommend the following settings:

Analytical balances *Extra fast ÷ medium*

Precision balances *Medium ÷ extra slow*

<Very fast>

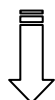

<Very slow>

The balance reacts quickly and in a sensitive manner, quiet set-up location.



The balance reacts slowly and in a robust manner, busy set-up location



Stability display

The stabilisation sign will light up as soon as the weighing result remains constant within the defined range.
Options: Fast, fast and accurate, accurate.

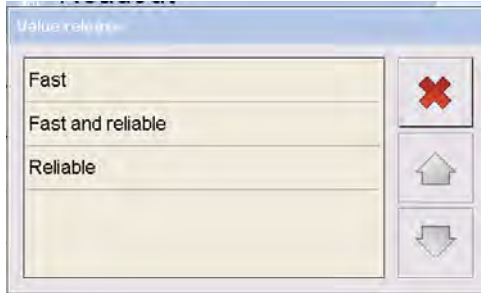

Tap **<Value release>**

The selection list will appear.



Auto Zero

The automatic zero point correction (auto zero) provides continuous adjustment for minor weight fluctuations, such as soiling on the weighing platform.

In the event that small quantities are removed or added to the material to be weighed, incorrect weighing results can be displayed due to the "stability compensation". (e.g. slow flow of liquids from a container placed on the balance, evaporating processes).

When apportioning involves small variations of weight, it is advisable to switch off this function.



Tap **< Auto-Zero >**

The selection list will appear.

No Auto zero function disabled

Yes Auto zero function enabled



Auto Zero: Dosing

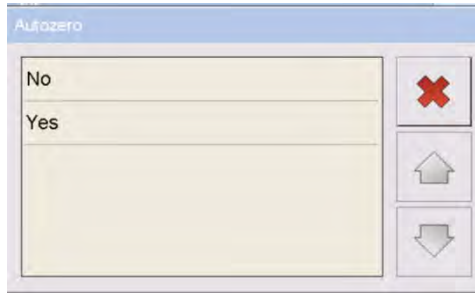

Tap < **Auto Zero Dosing** >

The selection list will appear.

No Auto zero function disabled

Yes Auto zero function enabled



Display exactness

Less display accuracy will result in a faster display.



Tap < **Last digit** >

The selection list will appear.

Always All places on

Never Last place off

When stable Last place only when stable weighing value on



Environment

This setting is used to adapt the weighing scale to ambient conditions at the place of installation.

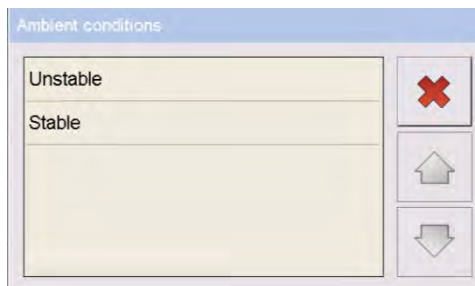

Tap < **Ambient conditions** >

The selection list will appear.

Unstable Unsteady environment / weighing scale is functioning slower

Stable Steady environment / weighing scale is functioning faster

- [ct]
- [lb]
- [g]

4. Weighing Units

This function is used to determine which weighing unit the weighing scale uses for operation.

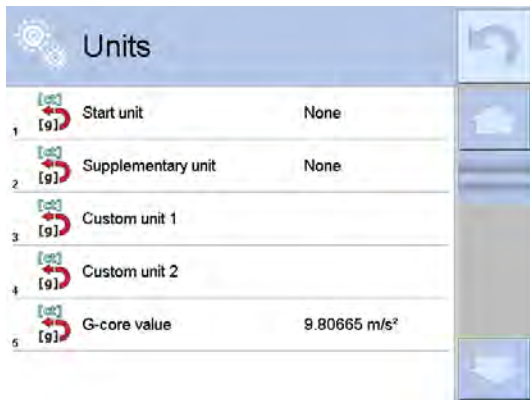

To call and change individual settings tap the icons.

< Start unit >

Unit displayed when weighing scale is started.

< Additional unit >

The selection of different units allows you to display the weighing result simultaneously in two different units.

<Definable unit 1>

Your own weighing unit can be defined in <Definable unit 1> and <Definable unit 2>.

<Definable unit 2>

These are used to determine which factor is to be used for calculating the weighing value.

<Gravitational acceleration>

Local gravitational constant is adjustable



8.5 Communication parameters

Via the interfaces weighing data may be exchanged with connected peripheral devices.

Connect balance using a suitable cable with the interface of the peripheral device. Flawless operation can only be achieved by using the optional interface cables available from KERN.

Available interfaces (see illustration chap. 1.2)

- COM 1 (RS 232)
- COM 2 (RS 232)
- Ethernet
- Tcp

Each interface must be configured according to the respective peripheral and desired function.

Call communication menu:

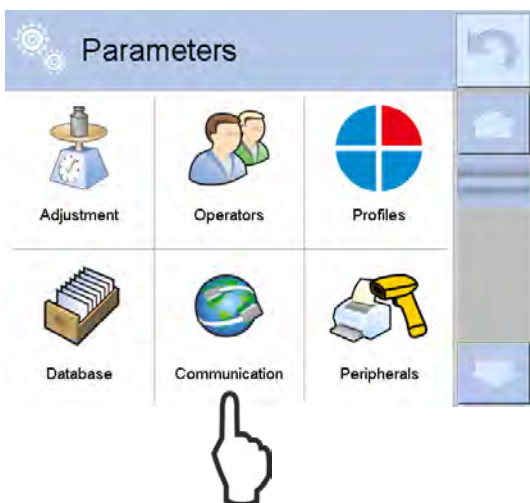

⇒ Press  or .

⇒ Tap < **Communication** >.

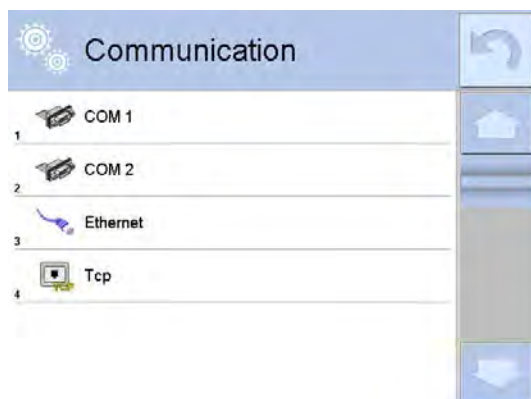

Select interface to be configured.



8.5.1 COM 1 / COM 2



Tap < **COM 1** or **COM 2**>

The configuration options will be displayed.

Select settings.

The communication parameters of weighing scale and peripheral must match.



8.5.2 Ethernet / IP

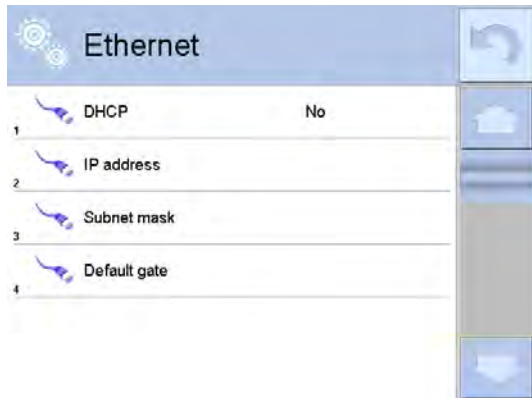

Tap < **Ethernet** >

The configuration options will be displayed.

DHCP	<input checked="" type="checkbox"/> yes	<input type="checkbox"/> no
IP-address	Automatic	manual
Subnet mask		
Default gate		



Set the transfer parameters in accordance with the local net.

After applying the changes restart using .



8.5.3 TCP



Tap <TCP>

Determine TCP port in input window.



The default value for KERN devices is "4001".



8.6 Equipment

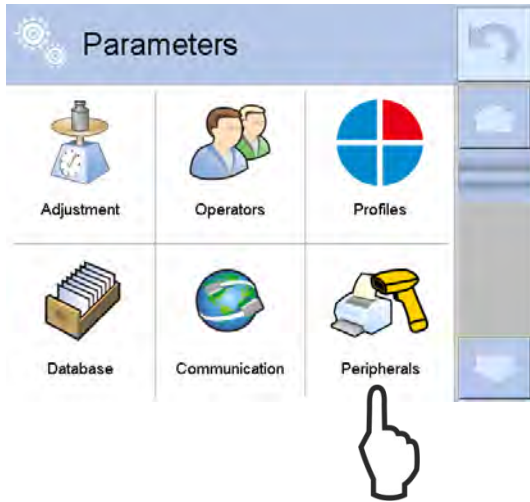

Tap <Peripherals>.

Select peripheral to be configured.



8.6.1 Computer

Selecting / configuring computer interface

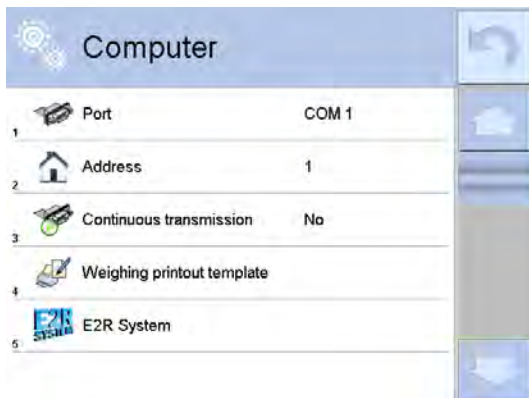

Tap < Computer >

The configuration options will be displayed.

1. Port

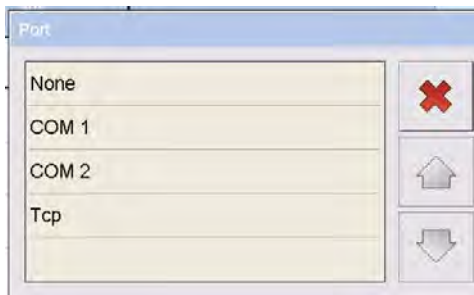

Tap **<Port>**.

The interfaces available for connecting the device to the computer will be displayed.

2. Address

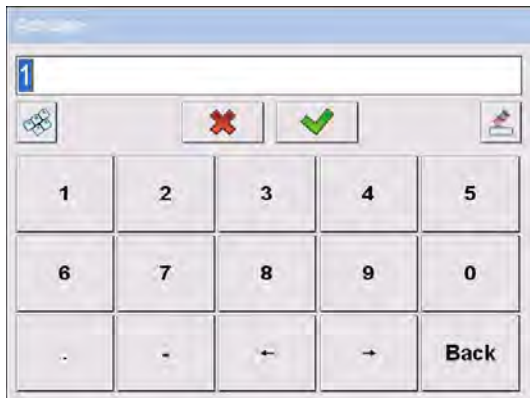



Tap **<Address>**.

Enter desired address in input window and confirm by .

3. Continuous transmission

Setting options:

-  no Continuous data transmission disabled
-  yes Continuous data transmission enabled

4. Print preview of weighing process

This is where you determine which information is to be sent to the PC.

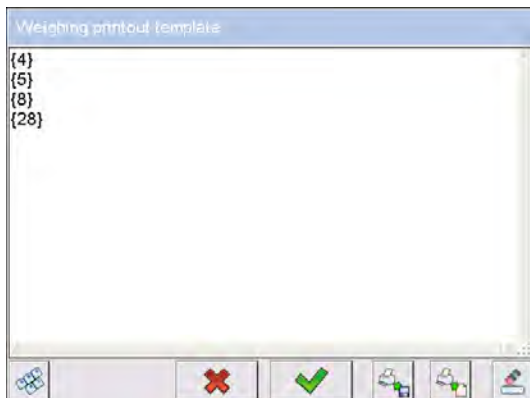

Tap < **Weighing printout template** >.

The input window will appear. Enter texts and variables (list of variables see chap.

24.1) and apply by .

⇒ Variables must be presented in curly brackets {x}.

⇒ To show the selection list of all

available variables, tap .

⇒ To insert a line break, press <Enter>.

⇒ To hide the keyboard / zoom out the

input window, press .

⇒ To retrieve a complete draft from a

USB storage medium, press .

⇒ To delete the editing field, press



5. E2R system

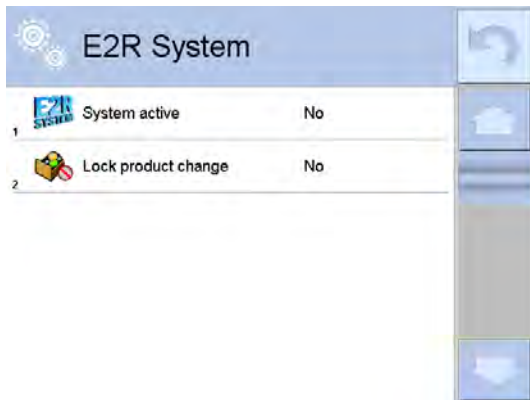



Tap < E2R System >.



The settings
<System enabled> /
<Lock product selection>
 have been locked by the manufacturer.

These settings can only be changed by
 the manufacturer!

Setting options:

-  no System disabled
-  yes System enabled

When functions are enabled, the following icons will be displayed on the top bar.

E2R System	 System enabled
	Active connection to PC software



8.6.2 Printer

Selecting / configuring printer interface

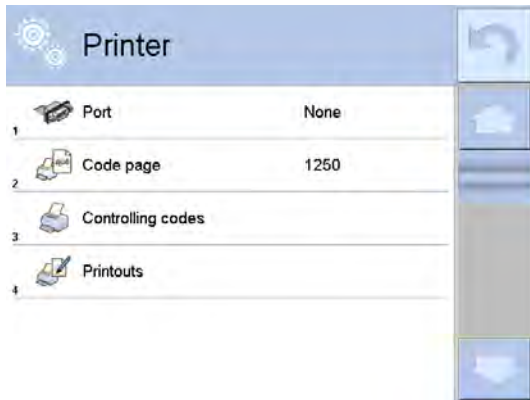

Tap **<Printer>**

The configuration options will be displayed.

1. Port

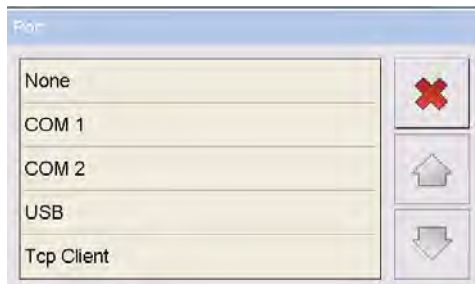

Tap **<Port>**.

The interfaces available for connecting the printer to the device will be displayed.

2. Code page



Tap **<Code page>**

Enter the desired value in the input window and confirm by .

3. Controlling code



Tap **< Controlling codes >**.

Enter the desired value in the input window and confirm by .

4. Defining reports

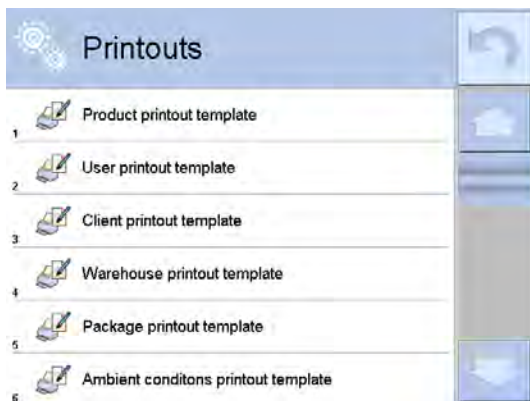

Tap **<Printouts>**.

Select report type and the input window will appear. Enter texts and variables (list of variables see chap. 24.1) and apply by .



Sample display:

Tap default report "Product" (factory setting)

⇒ Variables must be presented in curly brackets {x}.

⇒ Complete each line with "Enter"

⇒ Tap .

⇒ To insert a line break, press <Enter>.

⇒ To hide the keyboard / zoom out the

input window, press .

⇒ To retrieve a complete draft from a

USB storage medium, press .

⇒ Delete content of edition field by



Additional factory settings for default reports:

Product	{50}
	{51}
User	{75}
	{76}
Customer	{85}
	{86}
Store	{130}
	{131}
Packaging	{80}
	{81}
	{82}

Environmental conditions -----AMBIENT CONDITIONS-----

Date and time	{275}	
Temperature sensor 1:		{value} °C
Temperature sensor 1:		{value} °C
Temperature THBS:		{value} °C
Humidity THBS:		{value} %

Formula -----Formula -----

Name of formula:	{165}	
Number of ingredients:		{167}
Target weight of formula:		{168} g
Ingredients of formula:		
	{169}	



8.6.3 Barcode scanner

Select / configure interface

The barcode scanner enables fast access to:

- Product
- Customer
- Packaging
- Store
- Dosing processes
- Formula
- Ingredients of formula
- Universal variables
- Serial number
- Lot number



Ensure that the communication parameters of weighing scale (default 9600 baud) and barcode scanner match



Tap < **Barcode Scanner** >

The configuration options will be displayed.

1. Port

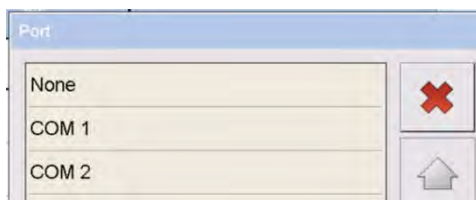

Tap <**Port**>.

The available interfaces will be displayed.

2. Offset



Tap < **Offset** >.

Enter in input window and apply by



3. Code length



Tap < **Code length** >.

Enter in input window and apply by





8.6.4 Transponder card scanner

Select / configure interface



Tap < **Transponder card scanner** >

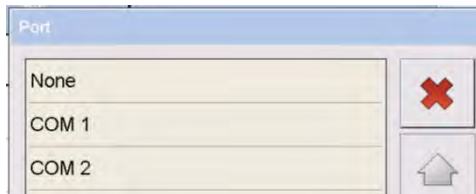

Tap <**Port**>.

The available interfaces will be displayed.



Ensure that the communication parameters of weighing scale (default 9600 baud) and transponder card scanner match.



8.6.5 Second display

Select / configure interface



Tap < **Additional display** >

1. Port

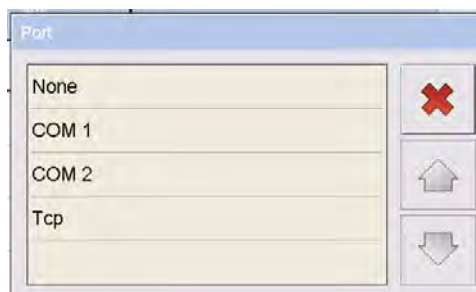

Tap <**Port**>.

The available interfaces will be displayed.

2. Draft



Tap **< Project >**.

The input window for defining the communication report will appear.

Factory settings:

{141} KERN KET-A03

{142} KERN KET-A06



8.6.6 Ambient conditions module

Select / configure interface

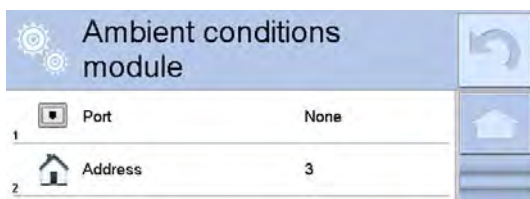

Tap **< Ambient conditions module >**

The configuration options will be displayed.

1. Port

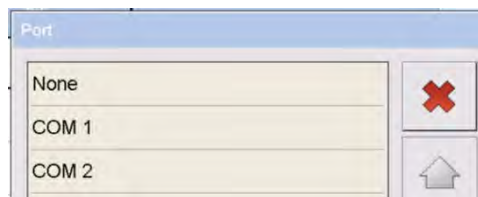

Tap **<Port>**.

The interfaces available for connecting the device will be displayed.

2. Address



Tap **<Address>**.

Enter desired address in input window and confirm by .

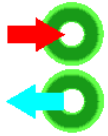

8.7 Inputs / outputs

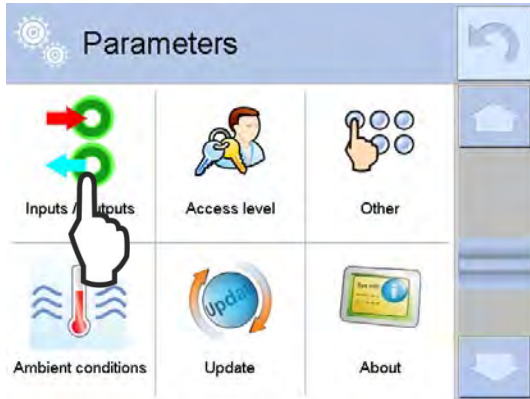

Tap < Inputs / Outputs >.

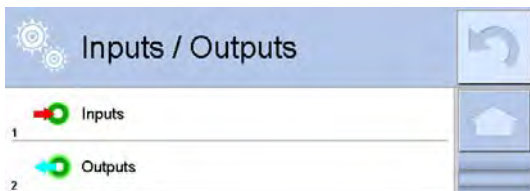

8.7.1 inputs



For pin configuration IN1 – IN4, see chap. 1.2

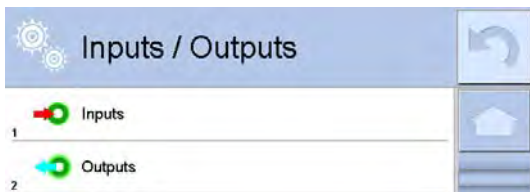

Tap < Inputs >.

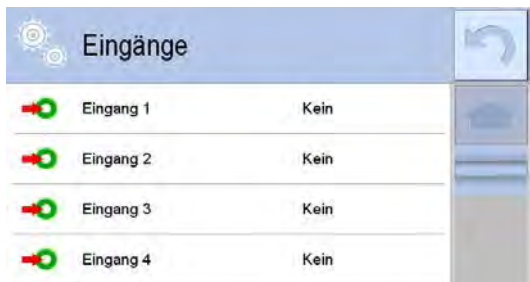

Select input (IN1 – IN4) to be configured.

Factory settings of all inputs: **<None>**.



Select action to be performed during enabling of input.

8.7.2 Outputs



For pin configuration OUT1 – OUT4, see chap. 1.2

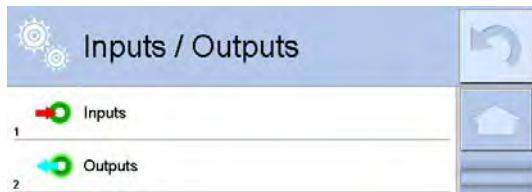

Tap < **Outputs** >.

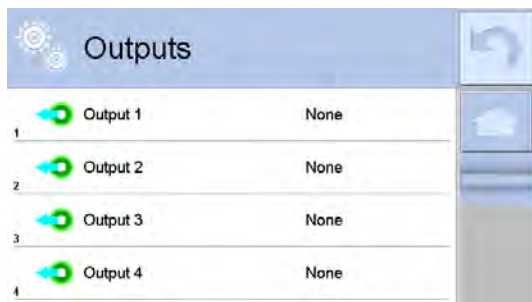

Select output

(OUT1 – OUT4 to be configured.)

Factory setting for all parameters is <none>.

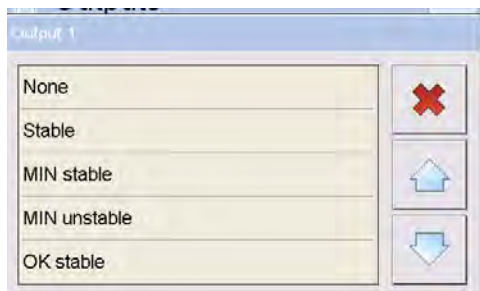

Select the event that is supposed to trigger enabling of output; see table below.

Table:

None	Output disabled
Stable	Stable weighing value above LO weight
MIN stable	Stable weighing value below threshold MIN
MIN unstable	Unstable weighing value below threshold MIN
OK stable	Stable weighing value between thresholds MIN and MAX
OK unstable	Unstable weighing value between thresholds MIN and MAX
MAX stable	Stable weighing value above threshold MAX
MAX unstable	Unstable weighing value above threshold MAX
Cycle end confirmation	Confirmation signal for cycle completion of dosing



8.8 General parameters

This is where the parameters influencing the operation of the weighing scale are set, such as user language, date / time display, key sounds, brightness of display etc.

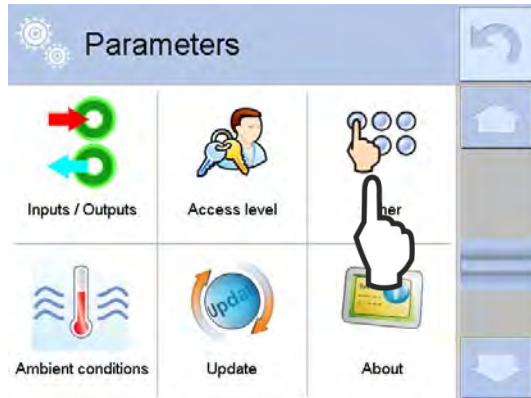

Tap < **Other** >.

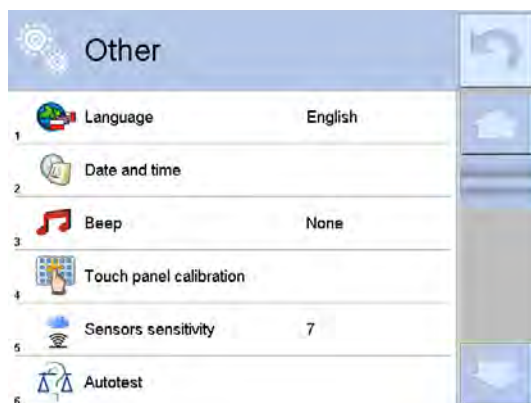

You can call the individual settings by tapping the icons and make changes as described below:



8.8.1 User language



Tap < **Language** >.

Select language.

The display will change directly to the selected language.



8.8.2 Entering date / time



Tap < **Date and Time** >

Enter date / time in the numerical input window.

Follow the instructions shown on the screen. Enter year, month, day, hour, minutes one after the other and apply every time by .

To apply, confirm query by .



Another option is to change date / time settings directly by tapping the date / time display in the main window; see chap. 3.2 [3]



8.8.3 Signal tone when pressing button

Every time you press a key, you will hear an audio signal as confirmation. You can enable / disable this function as follows.

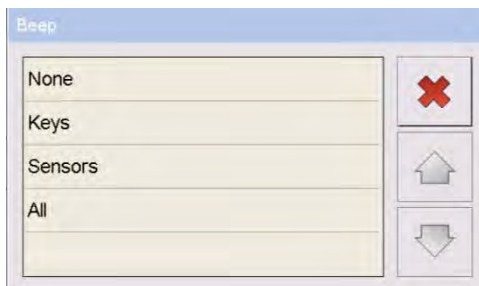

Tap < **Beep** >

The selection list will appear.

None Audio signal disabled

Button Audio signal will be sounded with every key stroke

Sensors The sensor confirms that it has detected and executed the command by sounding a beep.

All The audio signal is sounded when keys and optical sensors are operated.



8.8.4 Setting touch screen alignment

If the alignment of the touch-sensitive areas on the display do not match exactly the position of the command buttons you can correct their position with the help of this function.

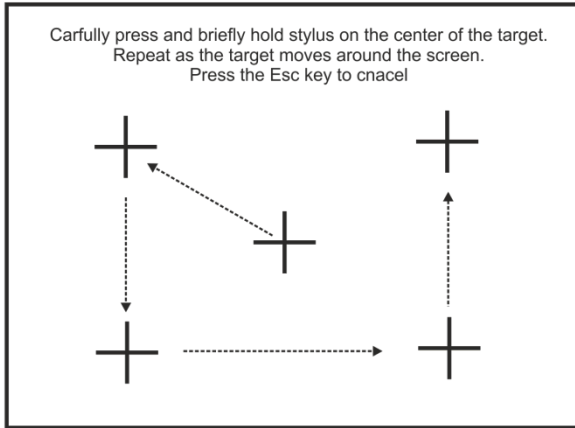

Tap **< Touch panel calibration >**.

To adjust the touch screen, follow the instructions on the screen.

Touch the centre of the cross as accurately as possible with a pen. Keep it pressed until the next cross appears.

Repeat this procedure for all items.

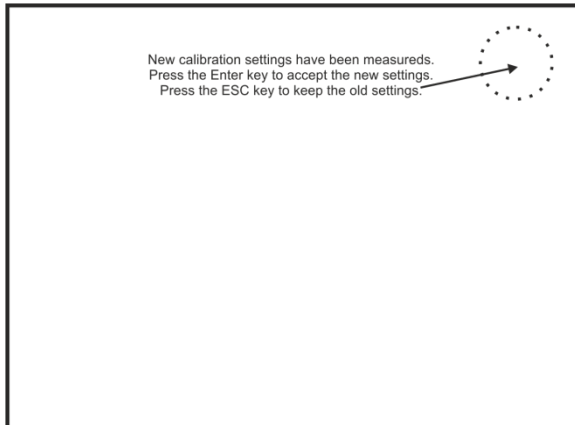

To confirm the new settings press the **PRINT** key.

To cancel, tap the screen in the top right corner.



- ☞ Ensure that you do not touch any other areas on the display during adjustment.
- ☞ Do not touch the display with your hand.
- ☞ You cannot interrupt the adjustment process.



8.8.5 Setting sensitivity of sensors

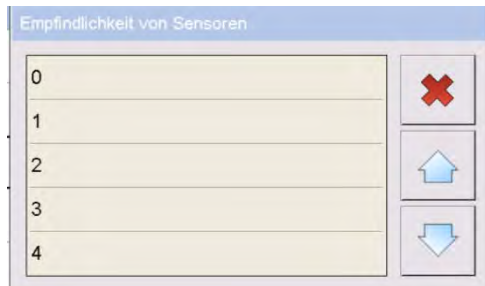

Tap < **Sensor sensitivity** >

Select sensitivity level, selectable from 0 – 9 (Default value is 5 - 7).



8.8.6 Auto test



Tap < **Auto test** >.

The selection list will appear:

- GLP auto test
- Auto test filter
- Service auto test (password-protected, not documented)

1. GLP auto test

This function is used to check the reproducibility of the adjustment.

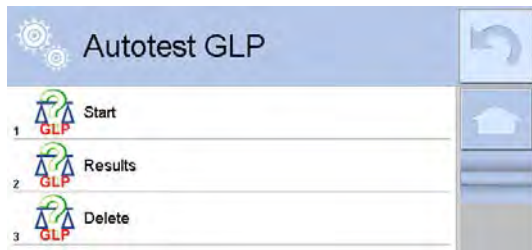

Tap < **Autotest GLP** >.

The selection list will appear:



Tap < **Start** > and the test will start automatically.

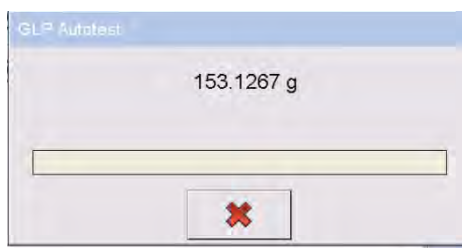

Sequence of operations:

- The internal adjustment weight will be placed and removed 12 times.
- Adjustment of weighing scale.
- Calculation and storage of default deviation



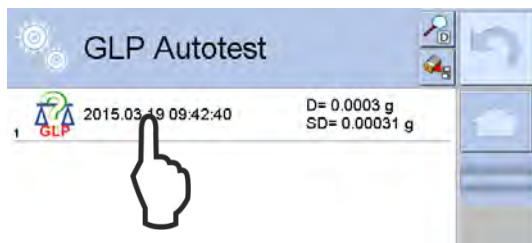

Tap < **Results** >





To < **Open / Print** > tap the desired data record.

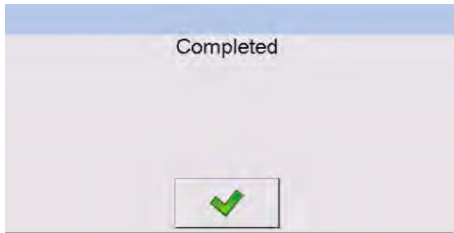

⇒ To print a report, press  (see printout example below).

⇒ To transfer data record to an USB storage medium, press .



Confirm deleting process by 

Printout examples (KERN YKB-01N):

----- Autotest GLP: Report -----	
Balance type	PET
Balance ID	132012
User	Admin
Software re.	L1.3.30 S
Date	2015.03.05
Time	11:11:29

Number of measurements	10
Reading unit	0.001 g
Internal weight mass	907.834 g
Filter	average
Value release	Fast & Reliable
Temperature: Start	24.94 °C
Temperature: Stop	24.97 °C

Deviation for Max.	-0.009 g
Repeatability	0.0004 g
Signature	
.....	

2. Auto test filter

The weighing scale determines the optimal filter setting for the current environment with the help of the parameters “reproducibility” and “transient effect” based on filter settings.

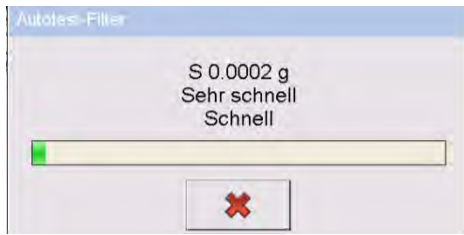

Autotest-Filter		
1	Sehr schnell Schnell	0.00053 g 6.187 s
2	Sehr schnell Schnell und genau	0.00057 g 5.547 s
3	Sehr schnell Genau	0.00043 g 6.648 s
4	Schnell Schnell	0.00035 g 6.353 s
5	Schnell Schnell und genau	0.00048 g 5.738 s
6	Schnell Genau	0.00044 g 4.575 s
7	Mittel Schnell	0.00019 g 4.764 s
8	✓ Mittel Schnell und genau	0.00030 g 5.340 s
9	Mittel Genau	0.00043 g 6.262 s
10	Langsam Schnell	0.00040 g 7.683 s
11	Langsam Schnell und genau	0.00032 g 6.025 s
12	Langsam Genau	0.00045 g 6.160 s
13	Sehr langsam Schnell	0.00035 g 6.307 s
14	Sehr langsam Schnell und genau	0.00036 g 5.792 s
15	Sehr langsam Genau	0.00046 g 6.985 s

Tap < **Auto test Filter** > and the test will be started automatically.

Sequence of operations:

The internal adjustment weight will be placed and removed 10 times during all filter settings.

The test checks reproducibility and transient effect of the display.

The entire test takes about 1 hour.

The result will be displayed.



⇒ To print a report, press  (see printout example below).

The optimal filter setting is marked by .



The results will be deleted on exiting this

display when pressing .

7	Mittel Schnell	0.00019 g 4.764 s	
8	Mittel Schnell und genau	0.00030 g 5.340 s	
9	Mittel Genau	0.00043 g 6.262 s	
10	Langsam Schnell	0.00040 g 7.683 s	
11	Langsam Schnell und genau	0.00032 g 6.025 s	
12	Langsam Genau	0.00045 g 6.160 s	

To retrieve the setting, tap the data record marked with



Autotest-Filter			
1	Filter	Mittel	
2	1,247 Bestätigung des Ergebnisses	Schnell und genau	
3	Wiederholbarkeit	0.00030 g	
4	Stabilisierungszeit	5.340 s	
5	Aktivieren		

Tap < >



To apply the optimum setting, confirm query by

Printout examples (KERN YKB-01N):

----- Autotest Filter: Report -----	
Balance type	PET
Balance ID	132012
User	Admin
Software re.	L1.3.30 S
Date	2015.03.05
Time	11:11:29

Reading unit	0.001 g
Internal weight mass	907.834 g
Temperature: Start	24.94 °C
Temperature: Stopp	24.97 °C

Filter	Very fast
Value release	fast
Repeatability	0.0008 g
Stabilization time	4,635 s

Filter	Very fast
Value release	Fast & Reliable
Repeatability	0.0009 g
Stabilization time	3.7465 s

Filter	Very fast
Value release	Reliable
Repeatability	0.0011 g
Stabilization time	3,933 s

Filter	fast
Value release	fast
Repeatability	0.0012 g
Stabilization time	4,635 s

Filter	Very fast
Value release	fast
Repeatability	0.0008 g
Stabilization time	3,509 s

	-
	
Filter	Very slow
Value release	Reliable
Repeatability	0.00098 g
Stabilization time	5,193 s
Signature	



8.8.7 Setting start logo (authorisation required)

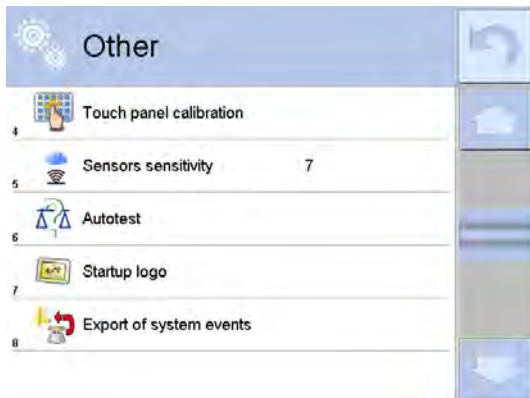

Tap < **Startup logo** >.

This function allows you to customise the start-up logo.

Connect the USB storage medium containing the start-up logo file.

Optimal resolution for start-up logo file (JPEG, PNG) 640 x 480 Pixel.

Tap < **Start logo** > and retrieve file.

The start-up logo will be updated on restarting.



8.8.8 Read error memory (Authorisation required)

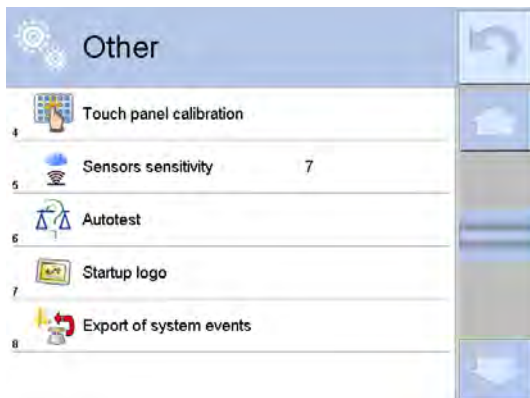

Connecting USB storage medium.

Tap < **Export system events** > and retrieve file.

Forward this file for diagnosis to KERN customer services.

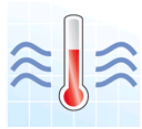

8.9 Environment

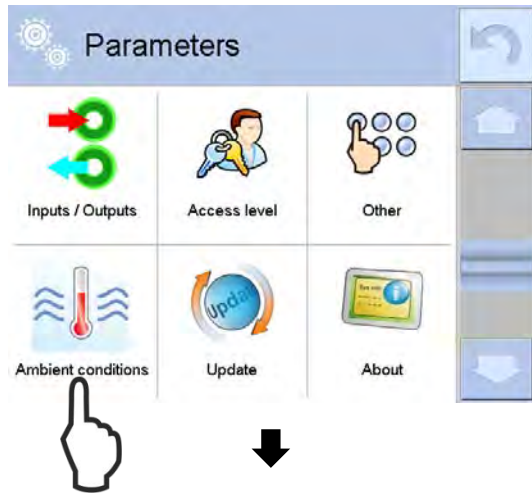

Tap **< Ambient conditions >**.



To call and change individual settings tap the icons.

1. Setting time interval for saving process

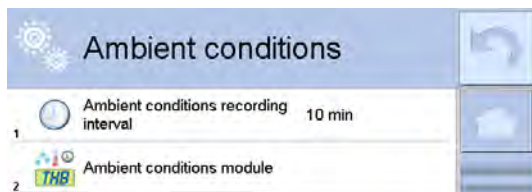

Tap **< Ambient conditions recording interval >**.



Select desired interval in displayed editing window.

Apply input by  .

2. Ambient conditions module

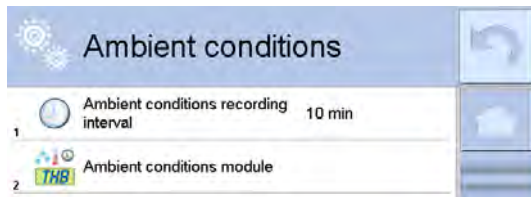

Tap <Ambient conditions module >.

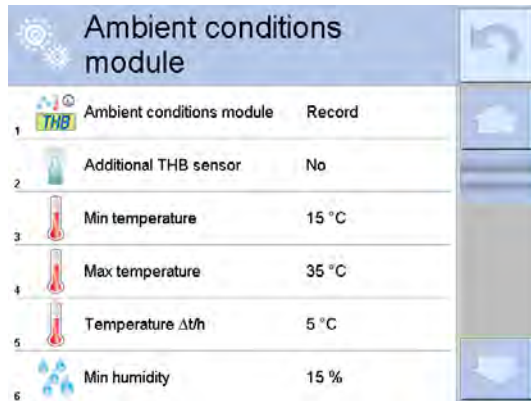

The selection list will appear.

To call and change individual settings tap the icons.



8.10 Info about system

This function is used to retrieve weighing scale information.

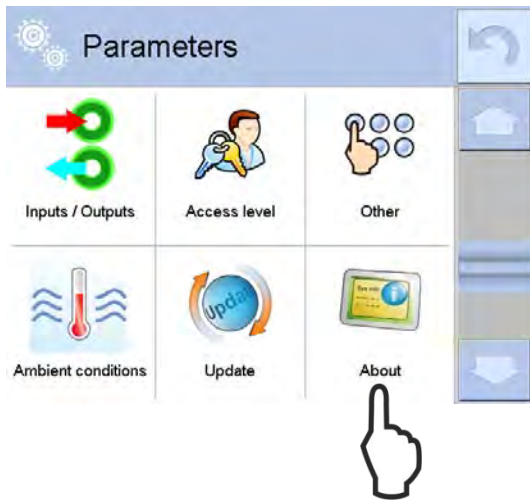



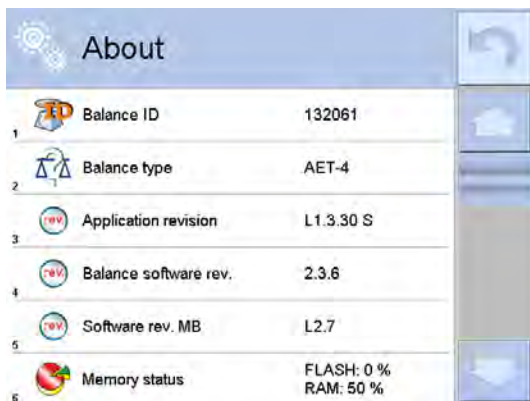









Tap < **About** >.



The information will be displayed.

9 Application settings

Overview of available applications:

	Weighing	see chap. 10.
	Parts counting	see chap. 11.
	Checkweighing	see chap. 12.
	Dosing	see chap. 13.
	Percent determination	see chap. 14.
	Density determination	see chap. 15.
	Animal weighing	see chap. 16.
	Formulation	see chap. 17.
	Statistics	see chap. 18.
	Pipette calibration	see chap. 19.
	Differential weighing	Not documented; for further information please contact KERN
	SQC (Statistics quality control)	Not documented; for further information please contact KERN

9.1 Selecting an application

⇒ Tap on the icon in the top left corner of the display window.

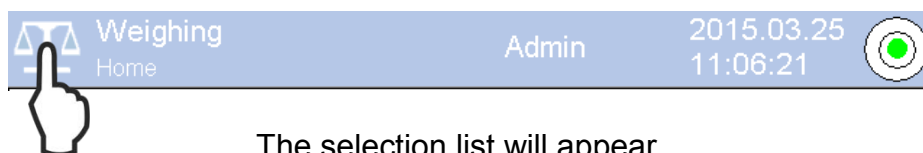

The selection list will appear.

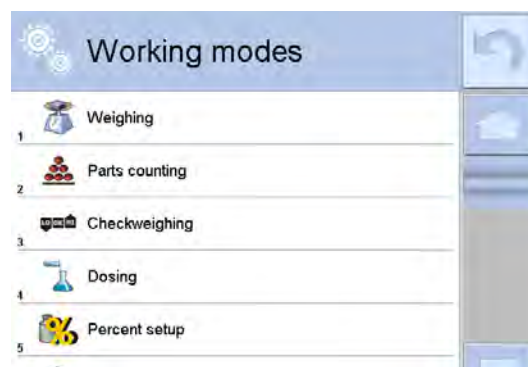

Tap desired application.

9.2 Selecting parameters

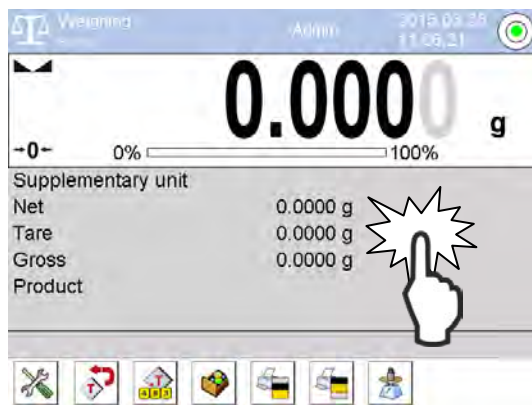

Tap grey info box

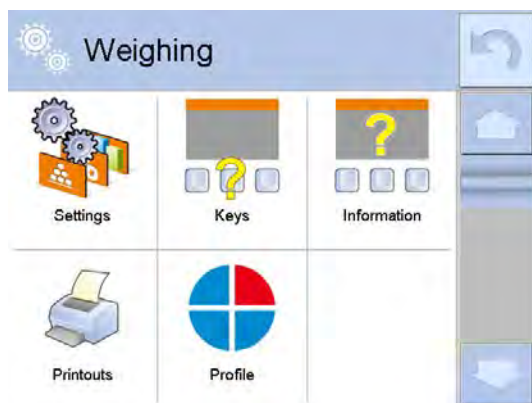

The menu will appear.

Tap desired menu and select the respective settings.

For additional descriptions see the chapters of the respective operating modes.



10 Weighing

The factory setting for the weighing scale is application weighing.





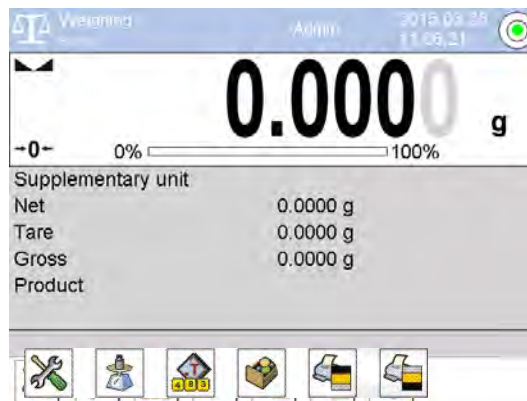

How to perform a simple weighing process is described in the chap. 7.6 "Basic operation". Apart from the operational steps described there (simple weighing, zero setting, taring, selecting weighing unit) the weighing system also offers options for customising the "weighing" application to your requirements.

10.1 Selecting an application

If you find that the "weighing" application is not enabled, tap the icon in the top left corner of the display window and select "weighing"  application (See chap. 9.1.).



The following function keys as well as a special info box for the weighing mode will be supplied enabled by the factory.

	Invoke a menu, see chap. 8
	Start adjustment
	Enter tare value as a numerical value
	Select product from database
	Print header
	Print footer

	For selecting additional function keys see chap. 10.2.2 For selecting additional information texts see chap. 10.2.3
---	--

10.2 Selecting parameters

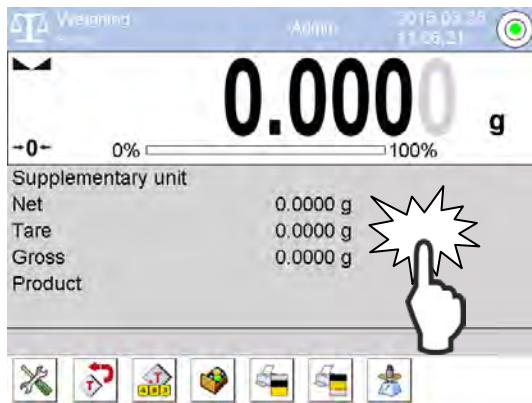

Tap grey info box

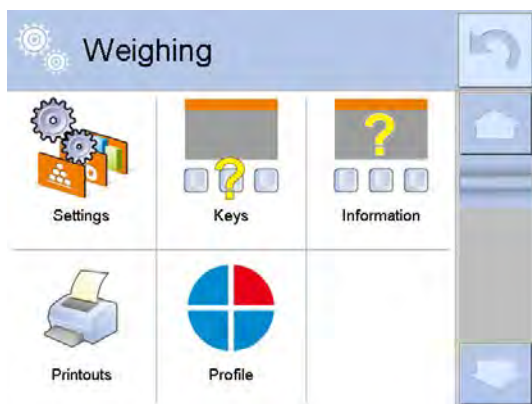

The menu will appear.

Individual menu items can be called and changed by tapping the icons.

- Settings, see chap. 10.2.1
- Keys/buttons, see chap. 10.2.2
- Information texts, see chap. 10.2.3
- Printouts, see chap. 10.2.4
- Profile, see chap. 10.2.5



10.2.1 Settings

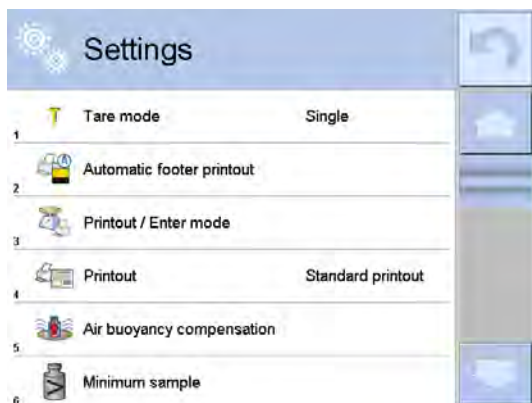

The available settings will be displayed.

To call and change individual settings tap the icons.

1. < Tare mode >



Tap < Tare mode >.

The following settings will be displayed and applied by tapping.

Subsequent tare weight

This function is used to tare repeatedly. The limit is reached when the whole weighing range is exhausted.

Example:

- ⇒ Position the first container or packaging and press the TARE key. The tare weight will be saved and the zero display as well as the indicator [Net] will appear.
- ⇒ Weigh the material, the net weight will be indicated.
- ⇒ Position second container or packaging material and again press the TARE key.
- ⇒ The loaded total weight will be saved as the new tare weight and the scales will return to zero display. Determine the load's initial weight in the second container and the net weight will be displayed.
- ⇒ For additional containers / packaging materials repeat these steps.

Total of all enabled

When selecting a product with a tare value from the database, you can increase this tare value numerically by the function key



. Each numerical tare value entry will overwrite the previous tare value. The basis will always be the original value from the database

Total of all

When selecting a product with a tare value from the database, you can increase this tare value numerically by the function key



. Each numerical tare value entry will be added to the previous tare value.

Autotare

Every first stable weighing value will be applied automatically as tare value. Zero display and indicator [Net] appear. Place the filled weighing container on the scales and the net weight will be displayed. For an unloaded weighing platform / zero display the tare value will be deleted automatically.

2. < Automatic printout footer >



Tap < **Automatic footer printout** >.

The following settings will be displayed and applied by tapping.

Mode	None Automatic output disabled Total of measurements The footer will be issued automatically as soon as the set threshold [g] is exceeded. Total of measurements The footer will be issued automatically when the set threshold [number of measurements] is exceeded.
Threshold	The set threshold must be exceeded before output is triggered. When <total of measurements> is selected the threshold value will be defined in the weighing unit [g]. When <number of measurements> is selected the threshold value will be defined dimensionless [number or measurements].

3. < Manual/automatic data output >

This function is used to determine whether and how data output has to take place, manual or automatic.

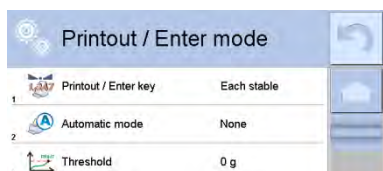

Tap < **Printout / Enter mode** >.

The following settings will be displayed and applied by tapping.

Key Printout / Confirmation	Never No data output will take place after pressing the PRINT key. First stable An output of the first stable weighing value will take place after pressing the PRINT key. New output only after zero display and stabilisation. Each stable Output of stable weighing values after pressing PRINT key Each Output will take place immediately after pressing the PRINT key, irrespective of whether the weighing value is stable.
-----------------------------------	---

Automatic mode	<p>None Automatic data output disabled</p> <p>First stable Automatic issue of first stable weighing value To achieve a new output, the value must fall below and then exceed the set threshold value.</p> <p>Last stable Output of last stable weighing value after unloading of weighing platform. To achieve a new output, the value must fall below and then exceed the set threshold value.</p>
Threshold	Setting threshold value in [g] that determines when data output must start.

4. < Default report / user defined >

This function is used to determine whether a default or user defined report is to be printed. Output will take place after pressing the PRINT key.



Tap < **Printout** >.

The following settings will be displayed and applied by tapping.

Standard Protocol	For defining default reports see chap. 10.2.4
Special printout	<p>Load desired report from selection list.</p> <p>For creating user defined reports see chap. 10.2.4</p>

5. < Air buoyancy compensation >

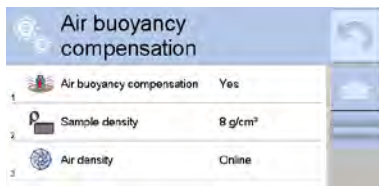

Tap < Air buoyancy compensation >.

The following settings will be displayed and applied by tapping.

Compensation of air buoyancy Yes

 No

Sample density Not documented

Air density Value

Enter known value for air density.

This value will be taken into account during compensation.

Online (Model AET 200-5DM only)

After selecting the option the value for air density will be loaded from the internal sensors of the weighing scales.



- The indicator [!] will be shown for weighing values with air buoyancy correction.



- The compensation of air buoyancy is only available for the “weighing” application.

6. < Min. initial weight >



Tap < **Minimum sample** >.

The following settings will be displayed and applied by tapping.

Method None

The function “minimum initial weight“, will be supplied locked by the factory.

Settings must be changed in situ in connection with DakkS calibration. For further information please go to KERN-Homepage (www.kern-sohn.com).

Mode Lock

If the weighing value falls below the minimum initial weight it cannot be saved or printed.

Warning

If the weighing value falls below the minimum initial weight it can never-the-less be saved or printed.

When the function is enabled, the measured weighing value will be compared directly with the specified minimum initial weight.

Any shortfall or exceeding of the minimum initial weight will be indicated by the tolerance marker shown on the screen.



Weighing value less than minimum initial weight

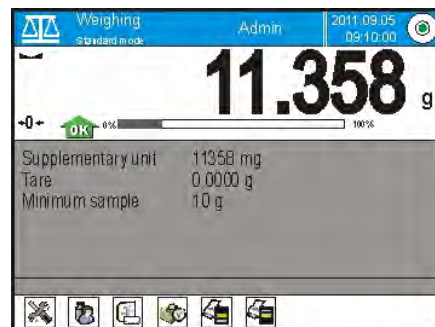

Weighing value greater than minimum initial weight

The tolerance marker shown on the screen supplies the following information:



Weighing value below minimum initial weight



Weighing value above minimum initial weight



Weighing value below minimum initial weight

The clock shown on the screen indicates that the validity of the minimum initial weight will expire in two weeks.



Weighing value above minimum initial weight

The clock shown on the screen indicates that the validity of the minimum initial weight will expire in two weeks.



The validity of the minimum initial weight has expired.



The function “minimum initial weight“, is only available with the “weighing” application.



10.2.2 Buttons

This is used to define which keys are supposed to carry out which functions.

- Shortcut keys see chap. 3.1
- Non-contact sensors see chap. 3.1
- Function keys
Function keys provide direct access to functions and settings frequently used for the enabled application. They will be displayed at the lower edge of the display.
List of function keys see chap. 25.



Tap < **Keys** > for actions such as determining which function keys are to be available in the application.



The numbers on the screen keys determine the order on the display.

Tap desired screen key.



The selection list will appear.

Use the cursor  to scroll up or down.

To apply, tap your selection. The display will return to the previous screen.

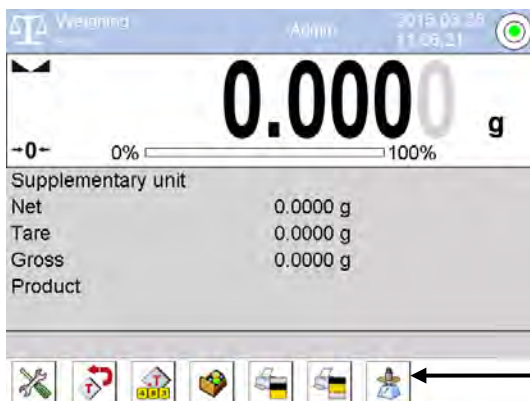

Back to enabled application, press  repeatedly

The function keys selected will be displayed at the lower edge of the display.



10.2.3 < Select information texts >

The info box is presented below the weighing value as a grey field on the display. In this area you will see additional information on the enabled application. To select which info boxes are to be displayed, tap the command button.

- i** The info box has space for a maximum of 6 information lines. If you select more than 6 lines, only the first 6 will be shown.
- i** The info box does not apply when the weighing value is presented zoomed out. The large weighing value display occupies the space of the info box.

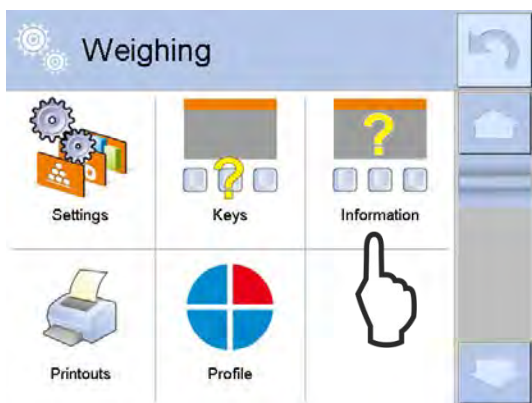

Tap <Information>.



Tap the desired information texts in the selection list.

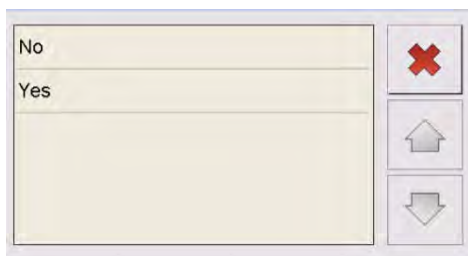

Accept the setting by pressing <yes> or <no>.

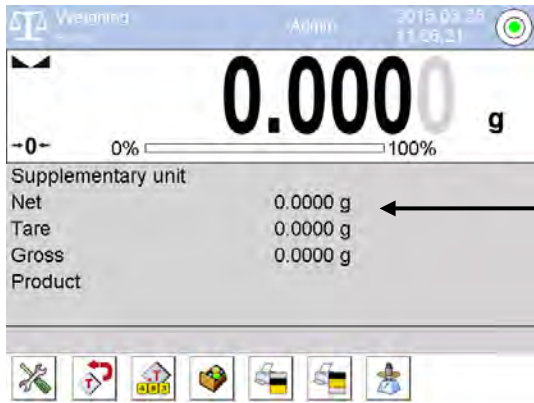

Back to enabled applicationress repeatedly



The selected information texts will be shown in the grey info box.

10.2.4 Define report

This function is used to determine which information is to be printed.

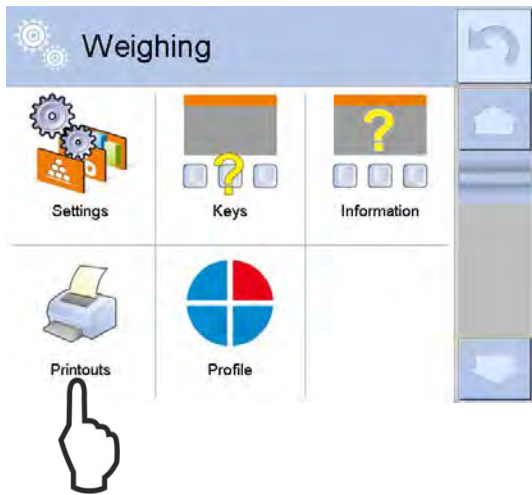

Tap < **Printouts** >.

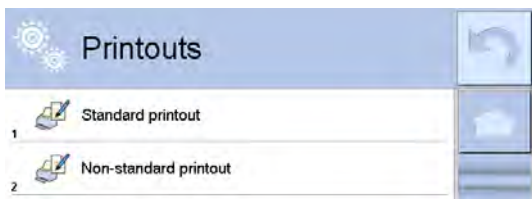

Select default or user defined report.

1. <Default report>

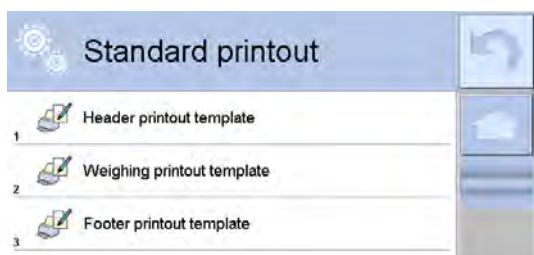

Tap the desired field in the selection list.



Print preview of header

This menu item is used to determine which information is to be printed on the header.

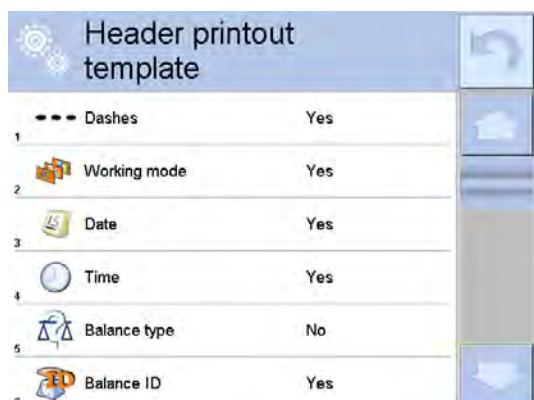

The selection list will appear.

All information accepted by <Yes> will be printed on the header.

The output will take place after pressing



the function key (Assigning function key with <Header printout> see chap. 10.2.4).

Selection list header:

- Lines (Insert dashed line- - - - -)
- Operation mode
- Date
- Time
- Type of weighing scale
- ID of weighing scale
- User
- Levelling (correct levelling yes/no)
- Customer
- Store
- Product
- Packaging
- Universal variables 1 - 5
- Empty line
- GLP report
- Special printout (see step 2 "User-defined report")



Print preview for weighing process

This menu item is used to determine which information is to be printed for the weighing result.

Weighing printout template		
1	N	No
2	Date	Yes
3	Time	Yes
4	Level status	Yes
5	Client	No
6	Warehouse	No

The selection list will appear.

All information accepted with **< Yes >** for the weighing result will be printed.

Printing will start after pressing



or the function key (Assigning **<Print>** to the function key, see chap. 0).

Selection list weighing result:

- N Printout of number of measurements
- Date Printout of current date
- Time Printout of current time
- Levelling Correct levelling yes/no
- Customer yes / no
- Store yes / no
- Product yes / no
- Packaging yes / no
- Universal variables 1 - 5 yes / no
- Net Printout of net value for current weighing process
- Tare Printout of tare value for current weighing process
- Gross Printout of gross value for current weighing process
- Current result Weighing result in currently displayed unit
- Additional unit The weighing result will be printed additionally in the selected additional unit.
- Weight Printout of weighing value for current weighing process
- Special printout See step 2. "User defined report"



Print preview for footer

This menu item is used to determine which information is to be printed in the footer after the weighing result.

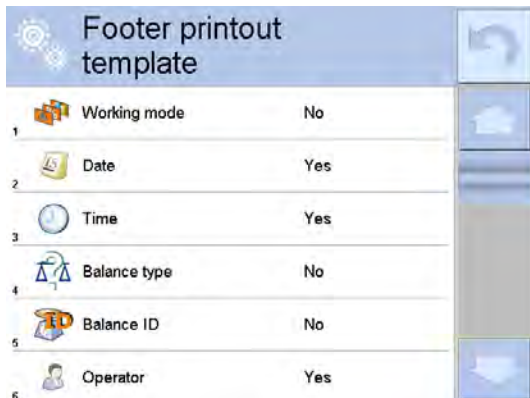

The selection list will appear.

All information accepted by **< Yes >** will be printed on the footer.

The output will take place after pressing



the function key **<Footer printout>** (Assigning **<Footer printout>** to the function key see chap. 10.2.2).

Selection list Menu footer:

- Operation mode Printout of enabled application
- Date Printout of current date
- Time Printout of current time
- Type of weighing scale The weighing scale type is taken from the weighing scale's electronics and therefore not adjustable.
- ID of weighing scale The serial number is taken from the weighing scale's electronics and therefore not adjustable.
- User yes / no
- Levelling Correct levelling yes / no
- Customer yes / no
- Store yes / no
- Product yes / no
- Packaging yes / no
- Universal variables 1 ... 5 yes / no
- Lines Dashed line "- - - -" will be inserted
- Empty line Printout of an empty line
- Signature Line for signature on report will be inserted
- Special printout See step 2. "User defined report"

2. User defined report

You can also define individual texts and variables for the report (See chap. 24.1).



Tap **<Non-standard printout>**.

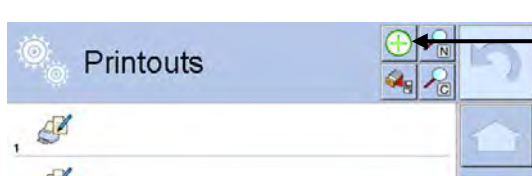

Tap key  **<Add>**

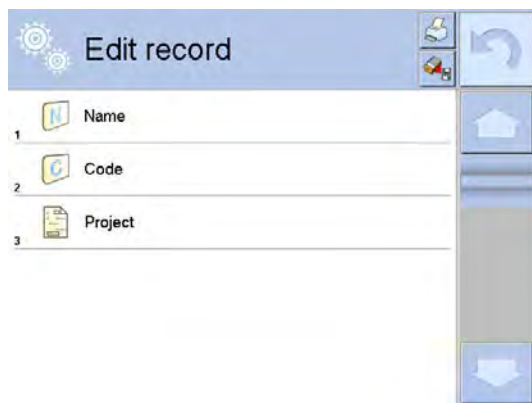

➤ **Name** Name for storage space in database

➤ **Code** Mark (barcode also permitted) for fast activation

➤ **Draft** Definition of print elements

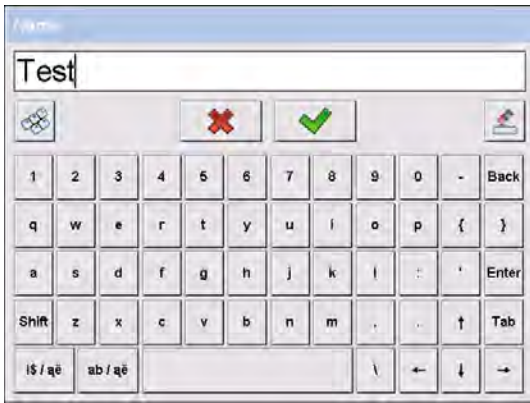

Tap **<Name>** button and the input window will appear. Enter name and confirm by .



Tap **<Code>** button and the input window will appear. Enter mark and confirm by .

Tap **<Project>** button and the input window will appear. Enter text and variables (Table see chap. 24.1) and confirm by .

⇒ Variables must be presented in curly brackets {x}.

⇒ Tap .

⇒ To insert a line break, press <Enter>.

⇒ To hide the keyboard or zoom out the

input window press .

⇒ To retrieve a complete draft from a USB storage medium, press



⇒ To delete the editing field, press

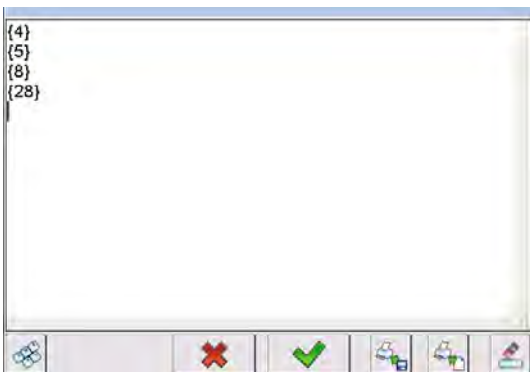

i The **<Settings>** ⇒ **<Printouts>** menu is used to determine whether the default or user defined report is to be applied as application specific setting; see chap. 10.2.1



10.2.5 Profile

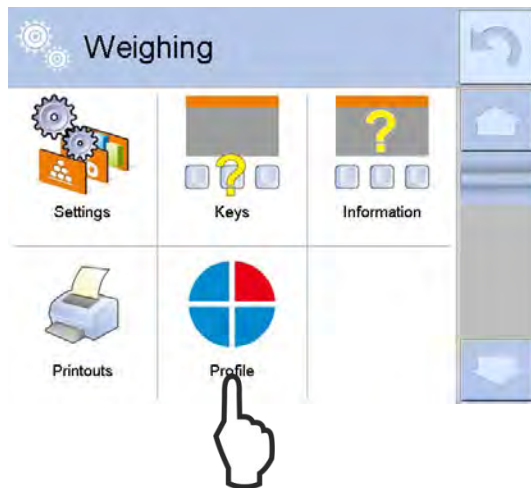

Tap <Profile>.

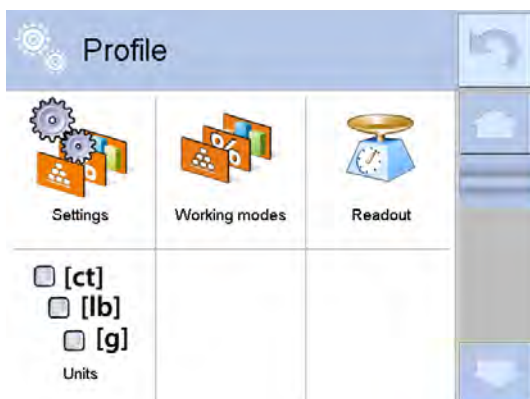

The following data records will be displayed.

- Settings
- Applications
- Weighing parameter
- Weighing Units

To call and change individual settings, tap the icons; see chap. 8.4.2.



11 Parts counting



Before the balance can count parts, it must know the average part weight (i.e. reference). There are several methods available for determining the reference single weight (See chap. 11.3.1 or chap. 11.3.2).

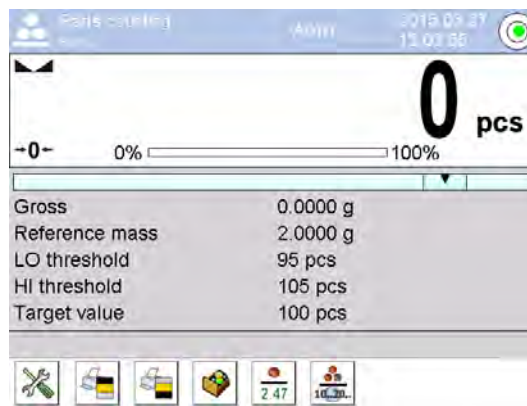

11.1 Selecting an application

For instance, tap the icon  in the top left corner of the display window and select application piece counting .

The piece counting window showing the unit “pcs” will appear.



The factory configuration provides two special function keys <   > as well as a special info box for piece counting.

	The reference single weight is entered as numerical value; see chap. 11.3.2
	The reference single weight is determined by weighing a known reference number of parts; see chap. 11.3.1

	For selecting additional function keys see chap. 10.2.2 For selecting additional information texts see chap. 10.2.3
---	--

11.2 Selecting parameters

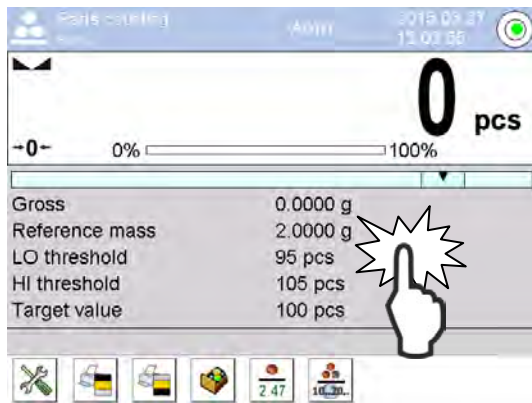

Tap grey info box

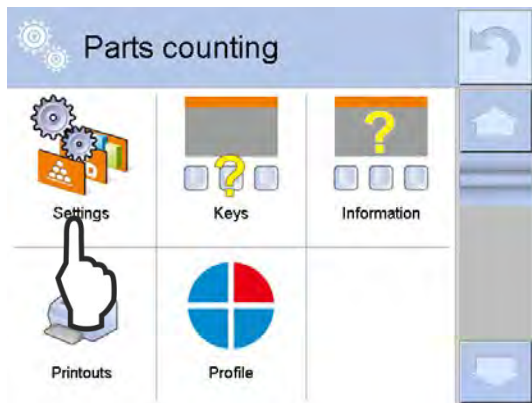

The menu will appear.

Individual menu items can be called and changed by tapping the icons.

- Settings, see chap. 11.2.1.
- Keys/buttons, see chap. 10.2.2
- Information texts, see chap. 10.2.3
- Printouts, see chap. 10.2.4
- Profile, see chap. 10.2.5



11.2.1 Settings

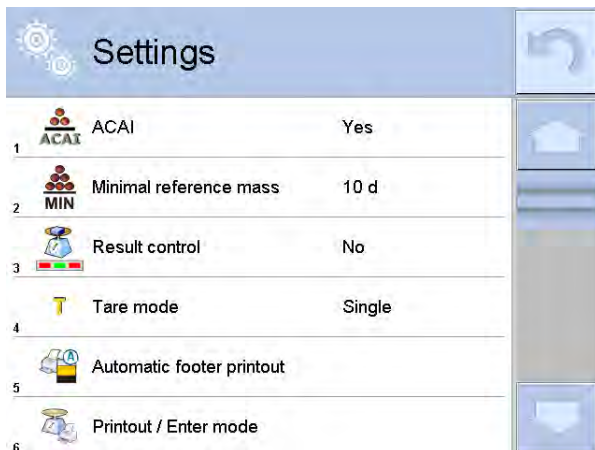

The available settings will be displayed.

To call and change individual settings tap the icons.



1. Automatic reference optimization

This function is used to specify whether the reference single weight is to be optimised automatically during counting.

At every reference optimisation, the reference weight is calculated anew. As the additional pieces increase the base for the calculation, the reference also becomes more exact.



2. Minimum reference single weight

When a reference single weight is entered that is less than the set readability, an error message will appear and the weight cannot be accepted by .



3. Tolerance check

While the function is enabled only weighing values within the tolerance limits will be saved or printed.



4. Tare mode

see chap. 10.2.1



5. Automatic printout of footer

see chap. 10.2.1



6. Manual / automatic data output

see chap. 10.2.1



7. Standard report / user-defined report

see chap. 10.2.1

11.3 Carry out parts counting

11.3.1 Determination of the reference piece weight by weighing

Determining reference:

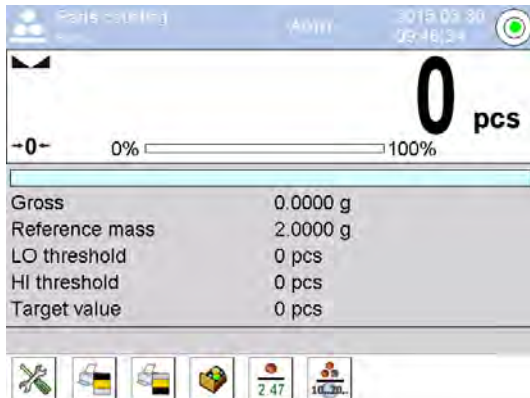

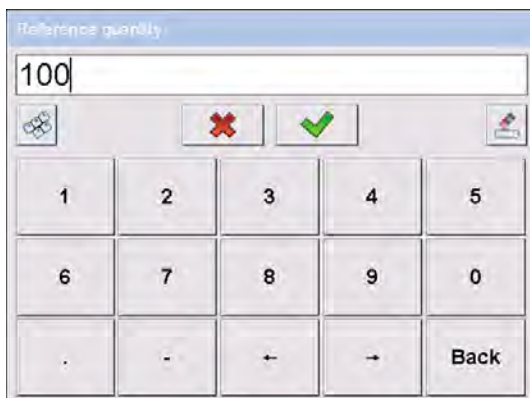

⇒ Reset balance to zero or tare the empty weighing container if necessary.

⇒ Press function key 

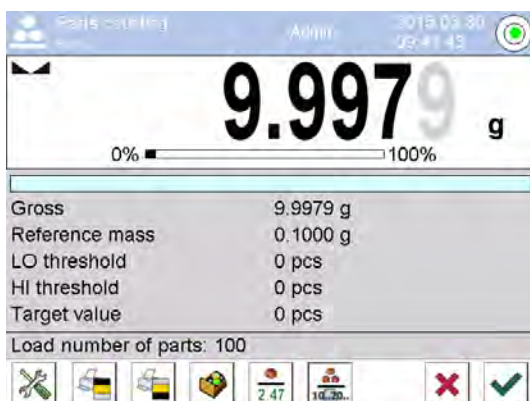

⇒ Enter the known number of reference parts (such as 100 items) via the numeric keys and confirm by .



⇒ Place the required number of reference parts (such as 100 items) on the scale. Wait until stability has been achieved and apply by .

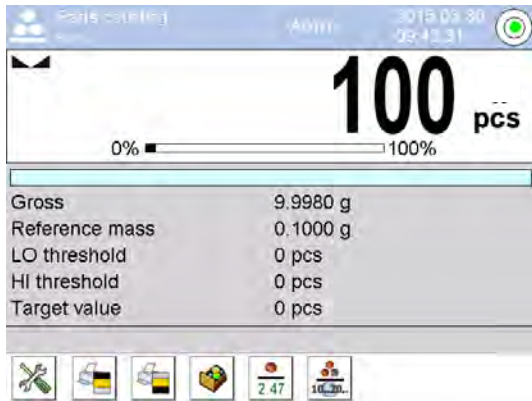

⇒ The weighing scale will determine the reference single weight and will show the result in the info box.

⇒ Remove reference weight.

Count the items:

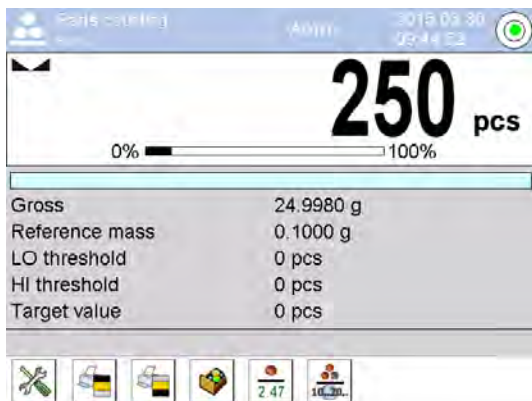

⇒ Tare if necessary, place weighing good and read off the number of items.

11.3.2 Enter reference single weight as numerical value

Set reference:

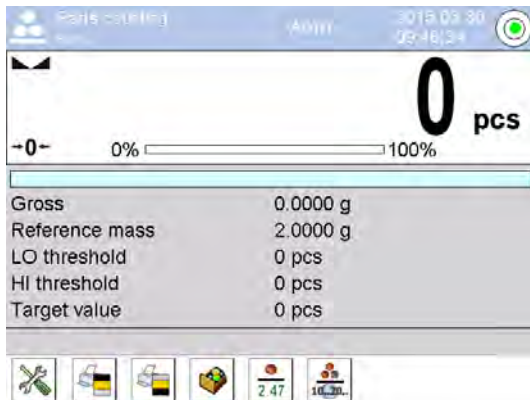

⇒ Press functional key 



⇒ Enter known reference single weight (such as 0.1000 g) via the numeric keys and confirm by .

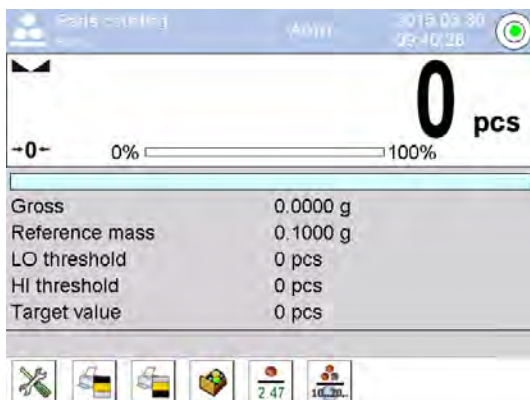

The entered reference single weight will be shown in the info box.

Count the items

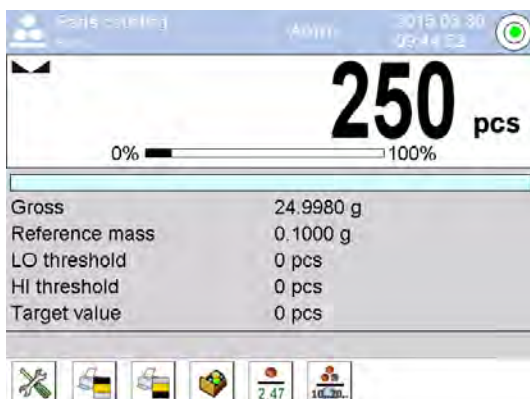

⇒ Tare if necessary, place weighing good and read off the number of items.

11.3.3 Load reference single weight from the product database

Load reference

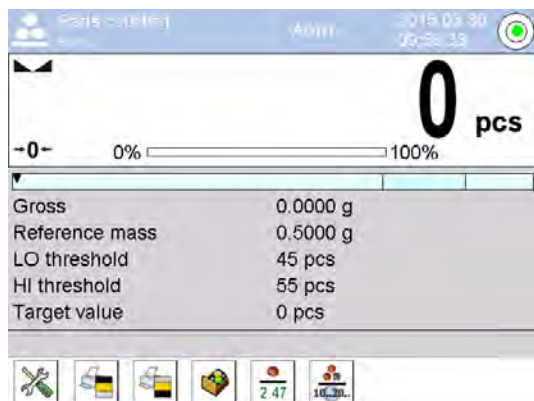

If a reference single weight has been assigned to a product in the database it can be loaded by

the function key  .

⇒ Select the product and the assigned reference single weight will be loaded.

Count the items

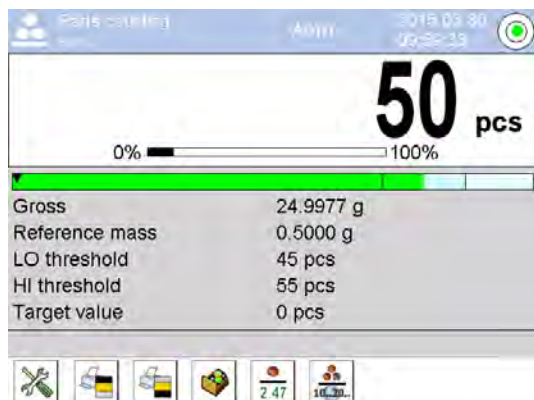

⇒ Tare if necessary, place weighing good and read off the number of items.

11.4 Assigning a reference single weight to a product in the database

⇒ For determining a reference single weight see chap. 11.3.1 or chap. 11.3.2

⇒ Press function key 

⇒ Keep finger pressed down on the selection until the context menu appears.

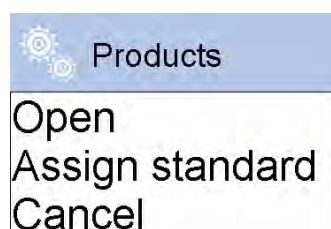

⇒ Tap < **Assign standard** >.

The reference single weight will be saved in the <database ➔ products> under the item < **Mass** >.

11.5 Adding up with tolerance control

Not the target value of the load is the deciding factor in this function but the departure from this target value.

Among such applications would be for instance the process control of parts in a manufacturing process.

Selecting parameters:

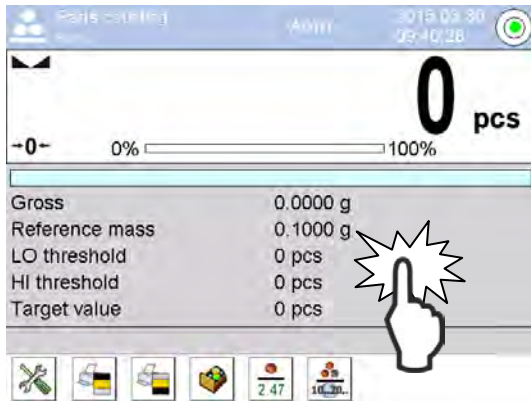

Tap grey info box

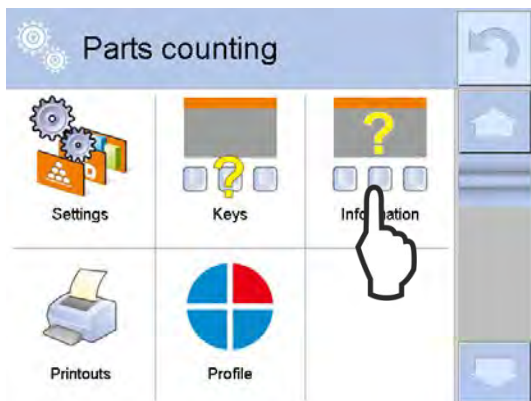

Tap **<Information>**.



Select bar graph **<Yes>**.

LO threshold select **< Yes >**

HI threshold select **< Yes >**

Back to last display by



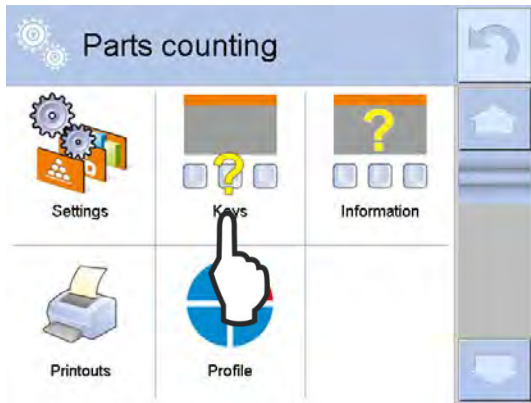

Tap **<Keys>**



Assign the function **<Check weighing thresholds>** to the function key.



Back to the piece counting window by

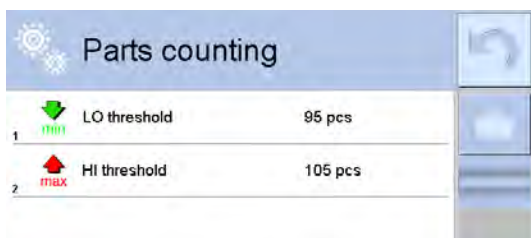

Operate the function key so as to enter the upper and lower limit for tolerance control.

Back to piece counting window by



Count the items

- ⇒ For determining a reference single weight see chap. 11.3.1 or chap. 11.3.2
- ⇒ If necessary tare, position load and start tolerance control.

Sample display:

Display

State

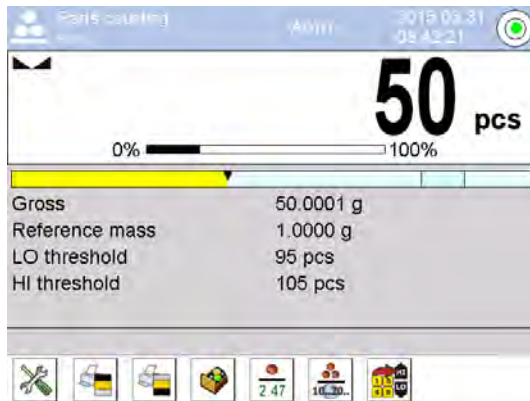

Number of parts below specified tolerance



Number of parts within specified tolerance

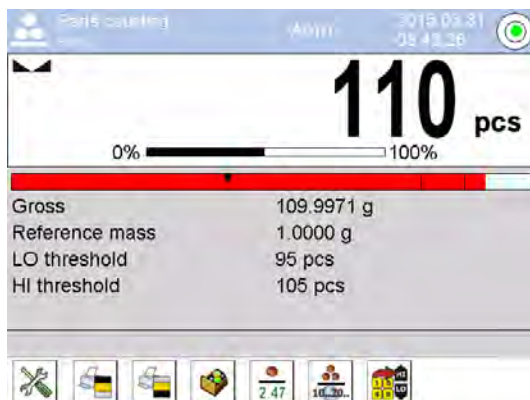

Number of parts exceeds specified tolerance

11.6 Adding-up to target value

This function facilitates adding-up to target value. The additional entry of a \pm tolerance allows you to determine the extent of accuracy during counting.

Selecting parameters:

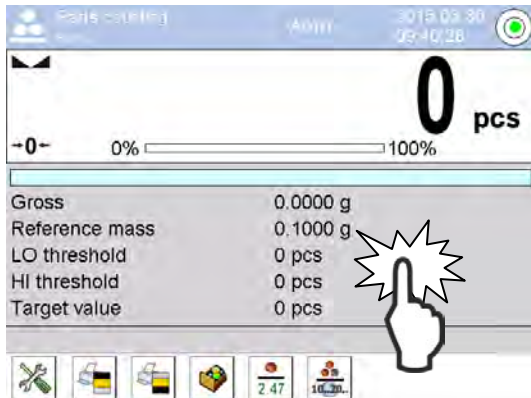

Tap grey info box

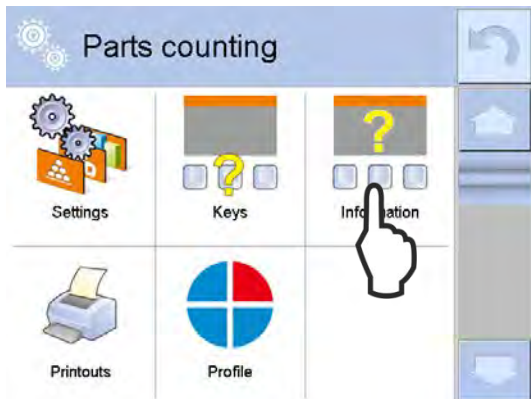

Tap <Information>.



Select bar graph <Yes>.

Select target value <Yes >

Select tolerance <Yes >

Back to the last display by



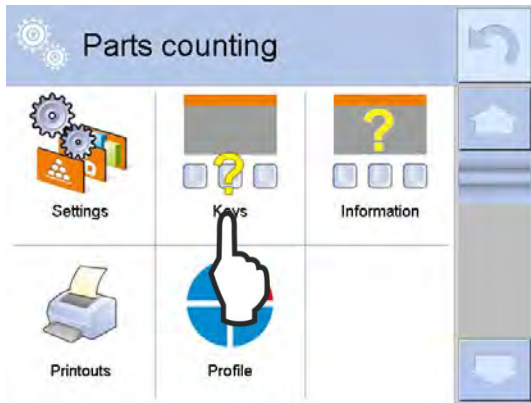

Tap <Keys>

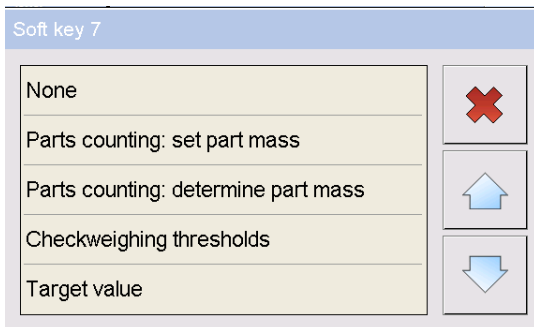

Assign the function "target value" to the function key.



Back to piece counting window by

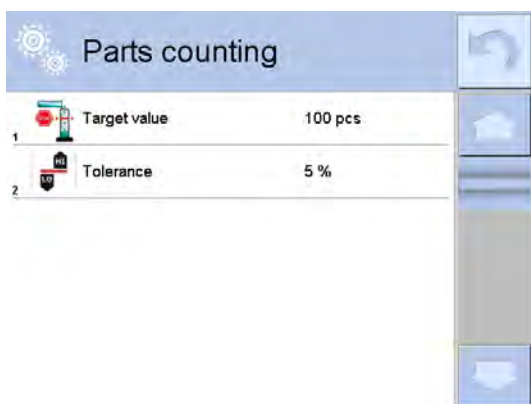

Operate the function key  so as to enter target value and, if required, tolerance (options 0 - 100%).

Back to piece counting window by



Count the items

- ⇒ For determining a reference single weight see chap. 11.3.1 or chap. 11.3.2
- ⇒ If required, tare, position load and start adding-up.
 The bar graph facilitates initial weighing according to target weight.
 The sample may be weighed approximately until the lower tolerance value has been reached and can be finely measured out up to target value, as required.
 The target value is marked as ▼.

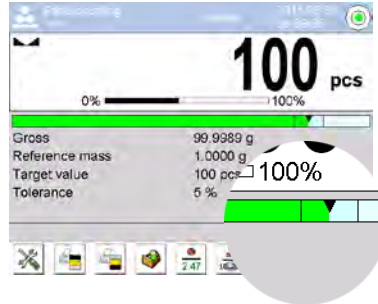

Sample display

State

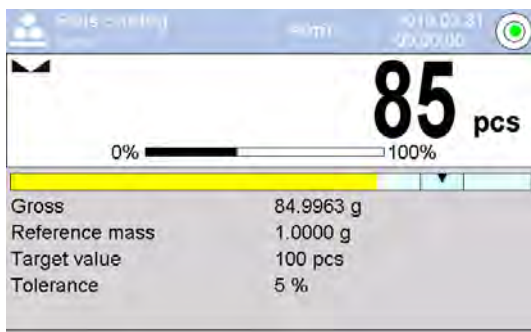

Number of part below specified target value

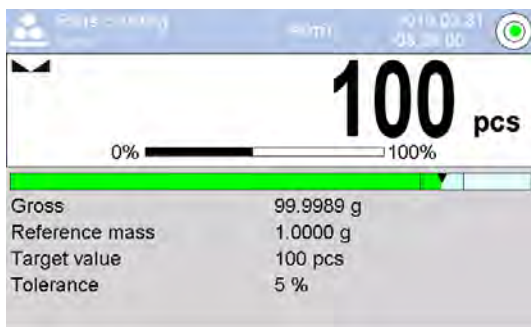

Target value reached and within specified tolerance

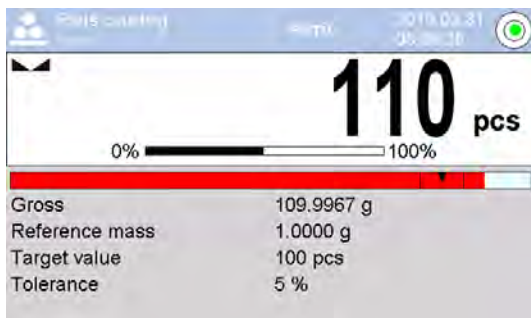

Number of parts above specified target value / tolerance



12 Checkweighing

You can determine an upper and lower limit during checkweighing (lower / upper threshold) and thus ensure that the weighed load remains exactly within the specified tolerance limits.

The bar graph facilitates checkweighing with the help of displays in different colours.

12.1 Selecting an application

For instance, tap the symbol  in the top left corner of the display window and select application checkweighing .

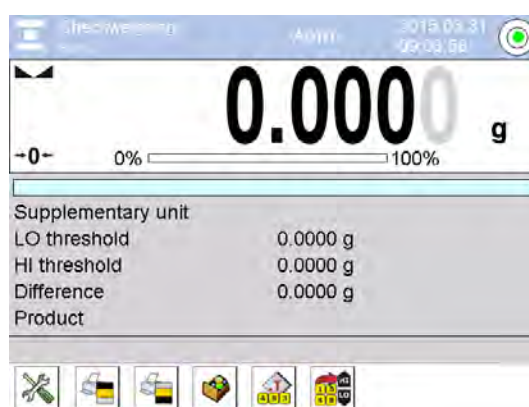

The factory configuration includes an enabled special function key <  > as well as a special info box for checkweighing.



For setting limits see chap. 12.3.1



For selecting additional function keys see chap. 10.2.2
For selecting additional information texts see chap. 10.2.3

12.2 Selecting parameters

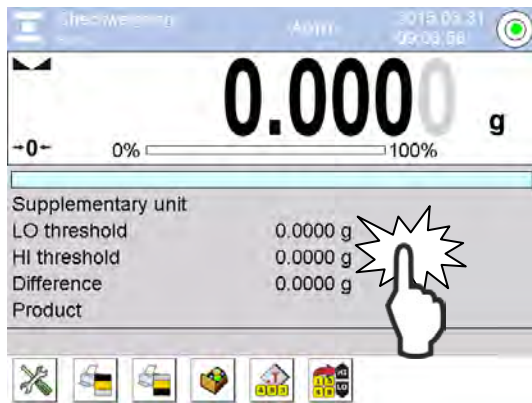

Tap grey info box



The menu will appear.

Individual menu items can be called and changed by tapping the icons.

- Settings, see chap. 12.2.1
- Keys/buttons, see chap. 10.2.2
- Information texts, see chap. 10.2.3
- Printouts, see chap. 10.2.4
- Profile, see chap. 10.2.5



12.2.1 Settings

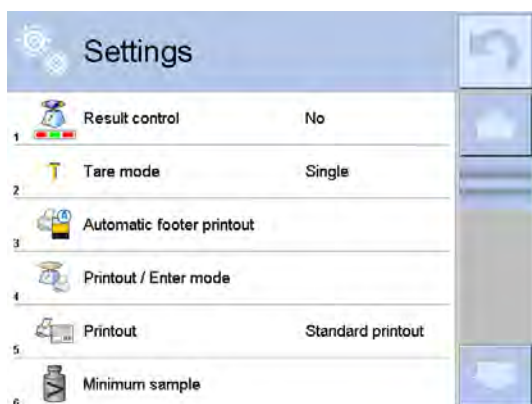

The available settings will be displayed.

To call and change individual settings tap the icons.



1. Checking results

<No> Weighing scale saves / logs each weighing process

<Yes> Weighing scale saves / logs only weighing processes that are kept within the limit values.



2. Tare mode

see chap. 10.2.1



3. Automatic printout of footer

see chap. 10.2.1



4. Manual / automatic data output

see chap. 10.2.1



5. Standard report / user-defined report

see chap. 10.2.1



6. Min. initial weight

see chap. 10.2.1

12.3 Carrying out checkweighing

12.3.1 Enter limit values via function key

Determine limit value:

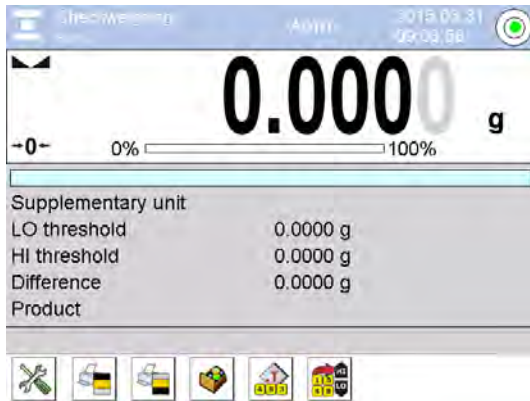

⇒ Press function key 



⇒ Enter lower and upper limit value via numeric keys and confirm by .

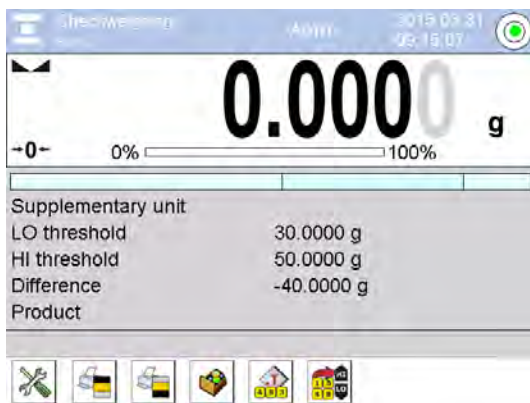

The following information texts will be displayed (factory setting):

- Additional unit
- Lower limit
- Upper limit value
- Difference states the \pm difference to the optimal target value.

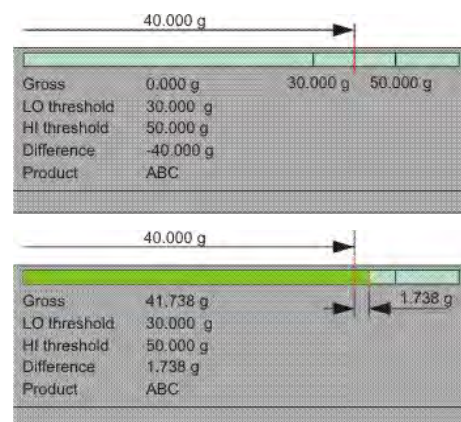

Checkweighing:

- ⇒ If necessary tare, position load and start tolerance control.
The bar graph display shows the sample weight with reference to the tolerance limits.

Sample display

State

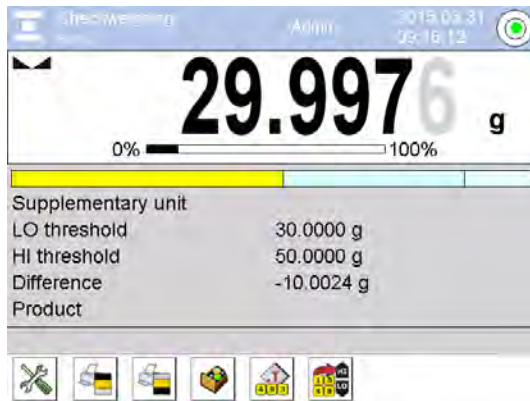

Load below specified tolerance

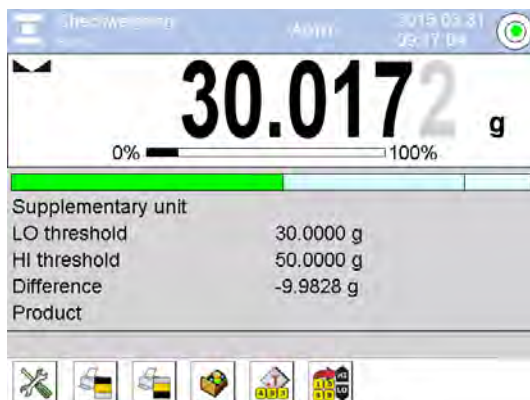

Load within specified tolerance

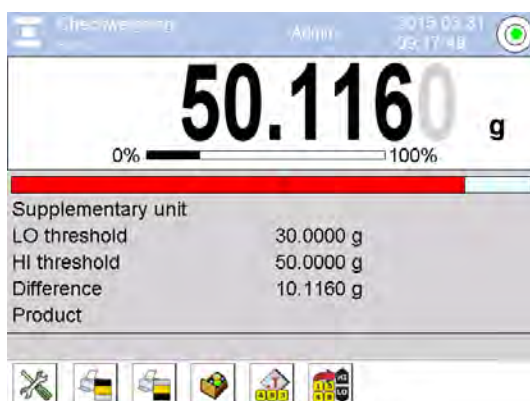

Load exceeds specified tolerance

12.3.2 Load limit values from database

Load limit values

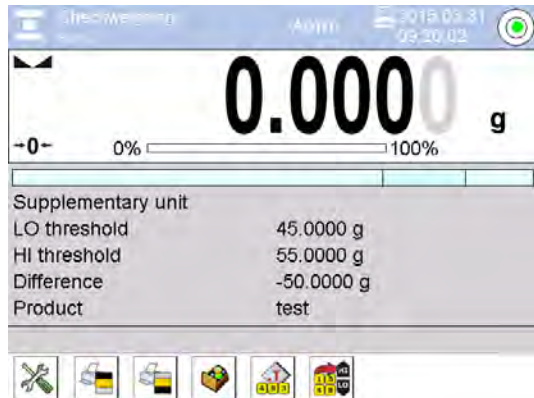

If in a database a product was assigned an upper and lower limit value, it may be

loaded via the function key  .

⇒ Select the product, the assigned limit values will be loaded.

For how to perform checkweighing see chap. 12.3.1



13 Dosing



You can fill a container up to a specified target weight during dosing.

The bar graph display will indicate the filling status.

The additional entry of a \pm tolerance allows you to determine the extent of accuracy to be applied during filling.

Tare	0.000 g	-10% +10%
Gross	0.000 g	
Target value	50.000 g	
Tolerance	10 %	
Product	ABC	

13.1 Selecting an application

For instance, tap the icon  in the top left corner of the display window and select application dosing .

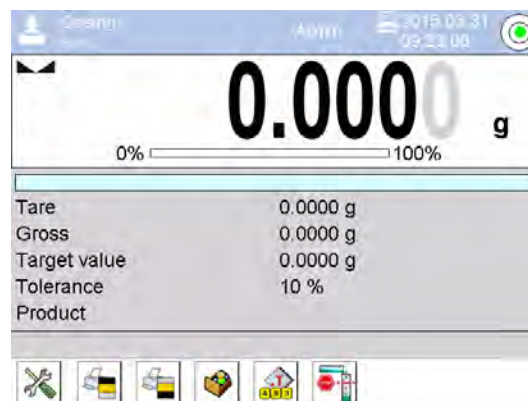

The factory configuration includes an enabled special function key  as well as an info box for dosing.



For determining target weight see chap. 13.3.1



For selecting additional function keys see chap. 10.2.2
For selecting additional information texts see chap. 10.2.3

13.2 Selecting parameters

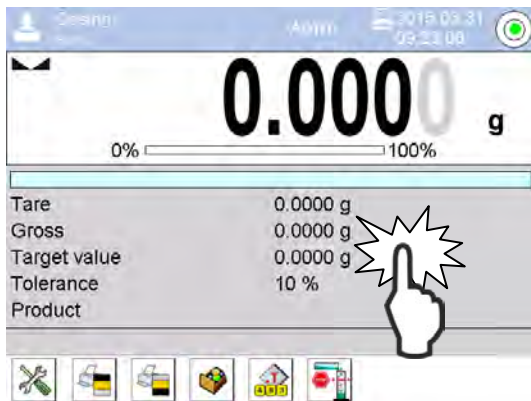

Tap grey info box

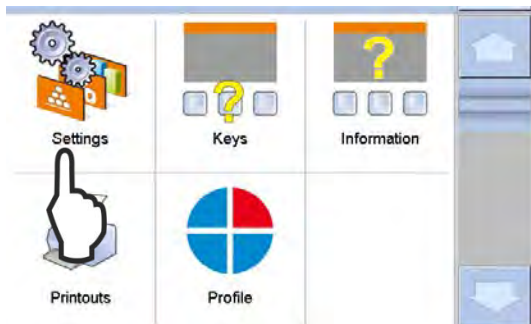

The menu will appear.

Individual menu items can be called and changed by tapping the icons.

- Settings, see chap. 13.2.1
- Keys/buttons, see chap. 10.2.2
- Information texts, see chap. 13.2.2
- Printouts, see chap. 10.2.4
- Profile, see chap. 10.2.5



13.2.1 Settings



The available settings will be shown; see chap 12.2.1.

To call and change individual settings tap the icons.

Back to the last display by





13.2.2 Information texts

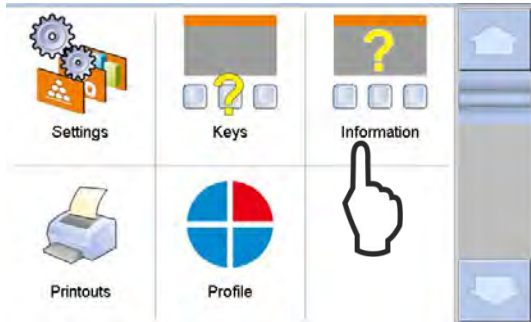

Tap <Information>.



Select bar graph <Yes>.

Select target value <Yes >

Select tolerance <Yes >

Back to dosing window by



13.3 Carry out dosing

13.3.1 Enter target weight manually

Determine target weight:

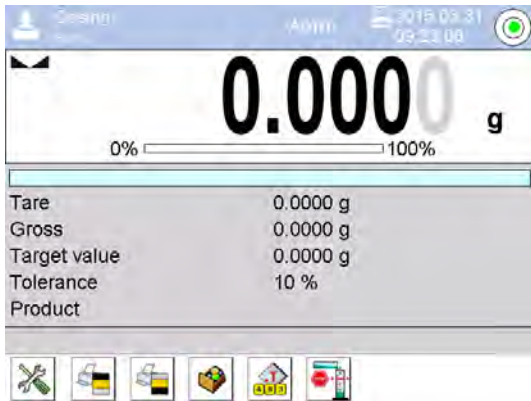

⇒ Press function key 

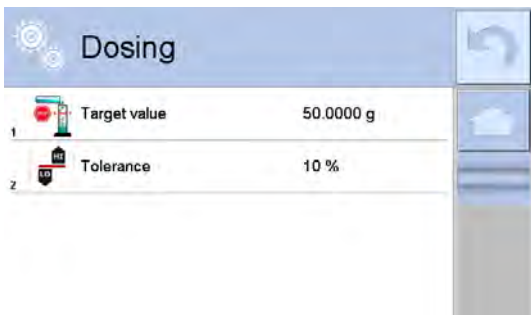

⇒ Use the function key  to enter target weight and, if required, tolerance (selectable 0 - 100%).

⇒ Back to dosing window by .

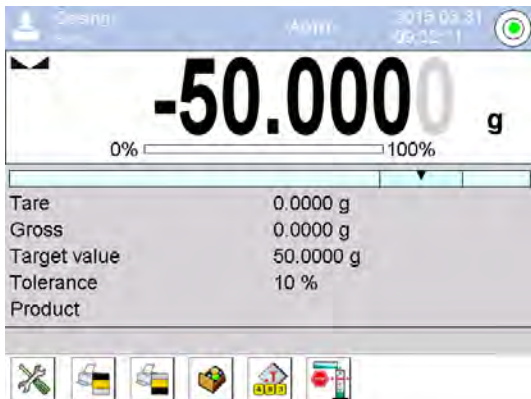

The negative value for the target weight will be displayed.

Start dosing process:

⇒ If required, tare and dose load.

The bar graph will show the filling status:

The sample may be weighed approximately until the lower tolerance value has been reached and afterwards can be finely dosed up to target value, as required.

The target value is marked as ▼ .

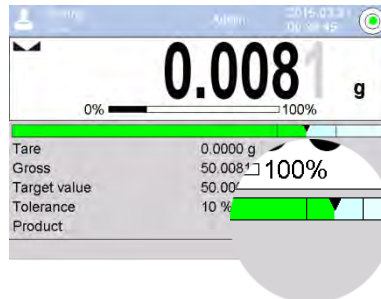

Sample display

State

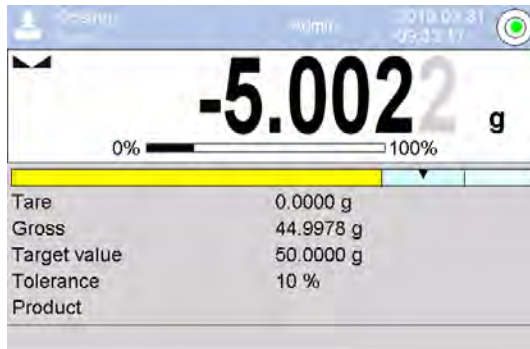

Load below specified target weight



Target weight has been reached and is within specified tolerance.

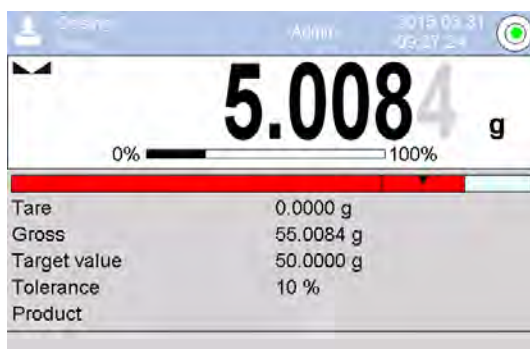

Load exceeds specified target weight / tolerance

13.3.2 Load target weight from product database

Load target weight / tolerance:

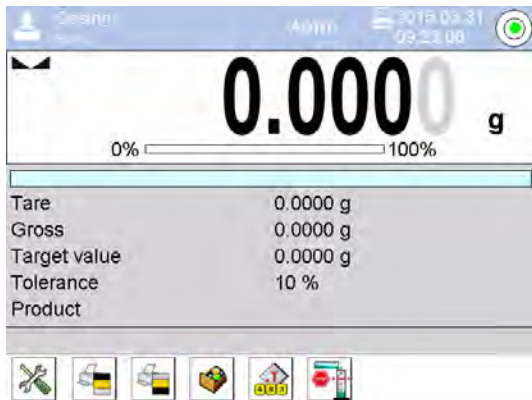

If a reference single weight has been assigned to a product in the database it can be loaded via the

function key  .

⇒ Select the product and the assigned reference single weight will be loaded.

Dosing:

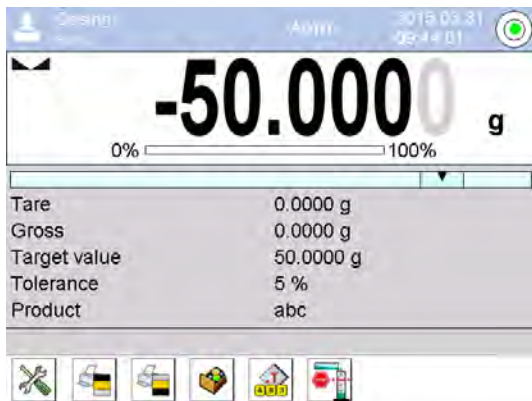

⇒ For how to start a dosing process see chap. 13.3.1





14 Percent determination

Percent weighing allows to display weight in percent, in relation to a reference weight (100%).



There are several methods available for the determination of the reference (see chap. 14.3.1 and chap. 14.3.2).

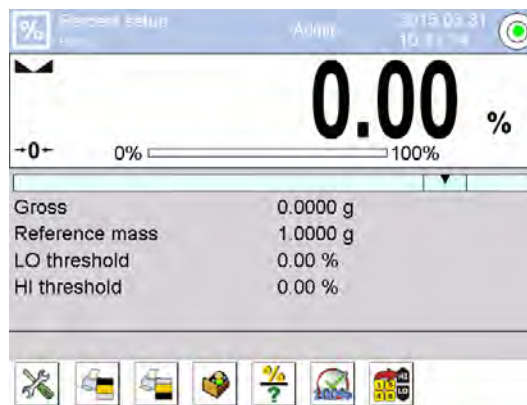

14.1 Selecting an application

For instance, tap the icon  in the top left corner of the display window and select application percentage determination .

The display for percentage determination including “%” unit will be shown.



The factory configuration provides two enabled special function keys <   > as well as a special info box for percentage determination.

	The reference weight is entered as sign; see chap. 14.3.2
	The reference weight is determined by weighing; see chap. 14.3.3

i	For selecting additional function keys see chap. 10.2.2 For selecting additional information texts see chap. 10.2.3
----------	--

14.2 Selecting parameters

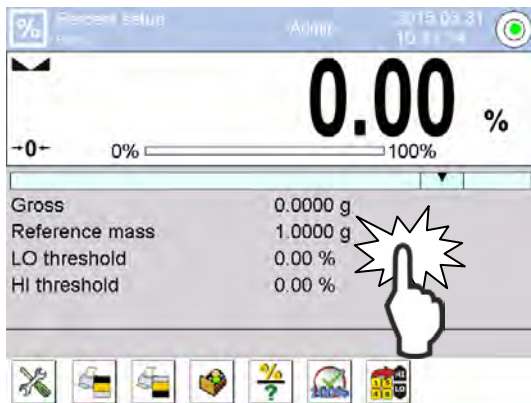

Tap grey info box

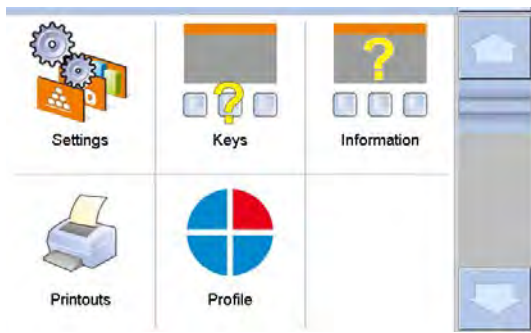

The menu will appear.

Individual menu items can be called and changed by tapping the icons.

- Settings, see chap. 12.2.1
- Keys/buttons, see chap. 10.2.2
- Information texts, see chap. 10.2.3
- Printouts, see chap. 10.2.4
- Profile, see chap. 10.2.5

14.3 Carrying out percentage determination

14.3.1 Determination of the reference weight by weighing

Determining reference:

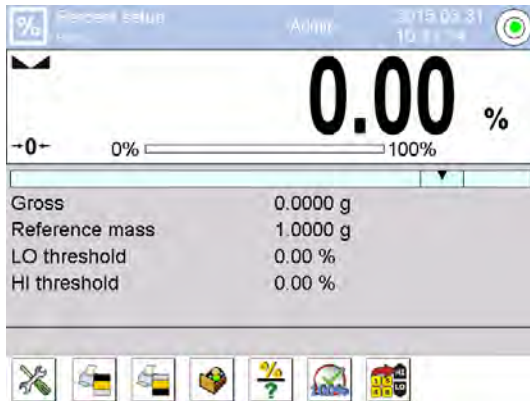

⇒ Reset balance to zero or tare the empty weighing container if necessary.

⇒ Place the reference weight that equals 100 %, wait for stability and

confirm by .

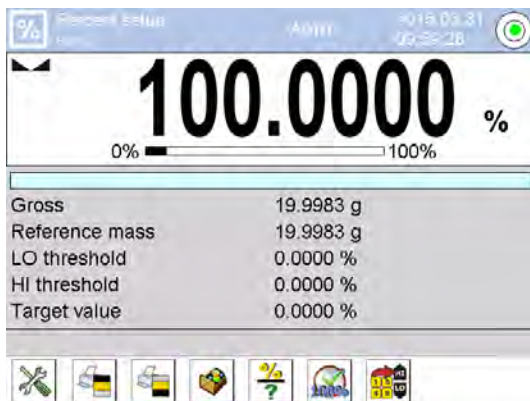

⇒ The weight will be accepted as reference (100%) and shown in the info box.

⇒ Remove reference weight.

Percent weighing

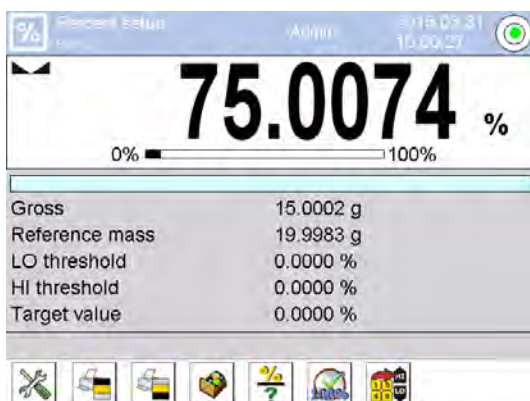

⇒ Place item to be weighed on balance. The weight of the item to be weighed is displayed in percent, with reference to the reference weight.

14.3.2 Entering a reference weight as sign

Set reference:

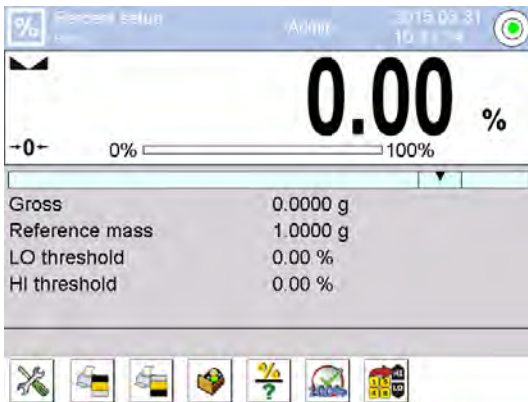

⇒ Press function key 



⇒ Enter know reference weight (such as 50 g) via the numeric keys and confirm by .

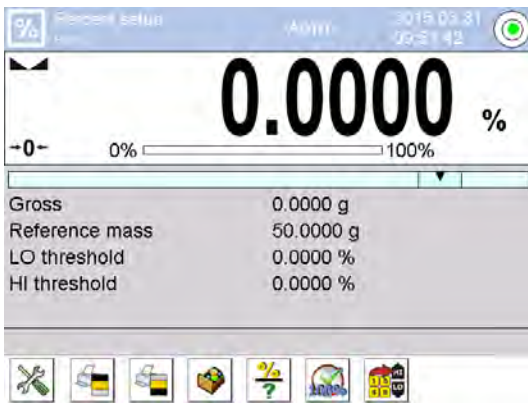

The entered reference single weight will be shown in the info box.

Percent weighing

7

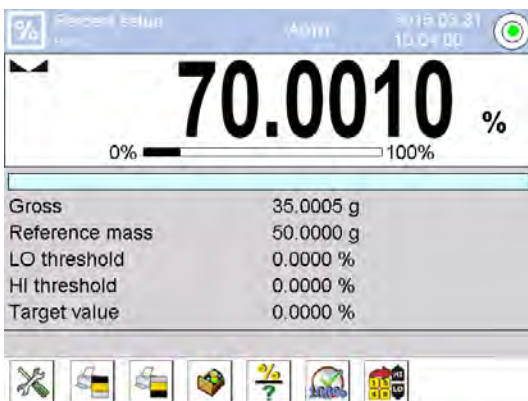

⇒ Place goods to be weighed on balance.
The weight of the item to be weighed is displayed in percent, with reference to the reference weight.

14.3.3 Loading a reference weight from the product database

Load reference weight:

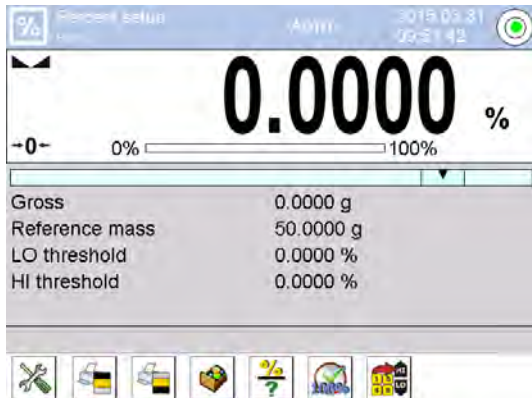

If a reference single weight has been assigned to a product in the database it

can be loaded by the function key 

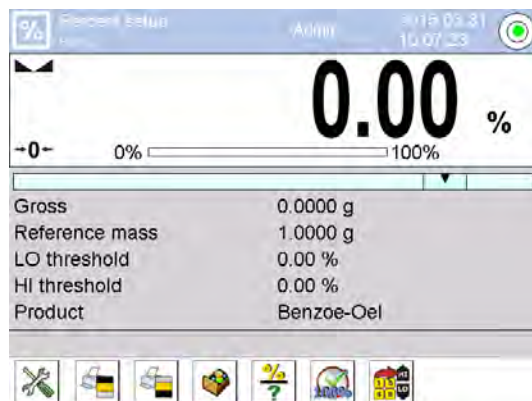

⇒ Select product and the assigned reference weight will be loaded.

Percent weighing

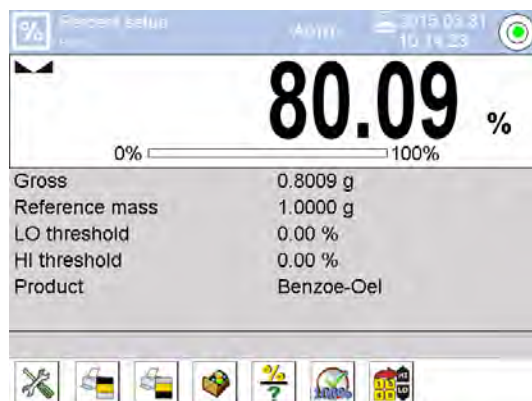

⇒ Place goods to be weighed on balance.
The weight of the item to be weighed is displayed in percent, with reference to the reference weight.

14.4 Tolerance control in percent determination mode

Selecting parameters:

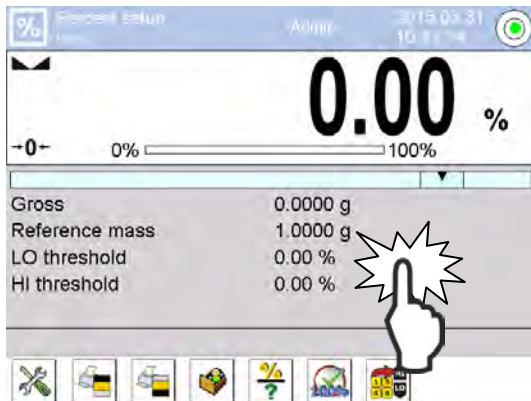

Tap grey info box



Tap <Information>.



Select bar graph <Yes>.

Select lower threshold <Yes >

Select upper threshold <Yes >

Back to the last display by



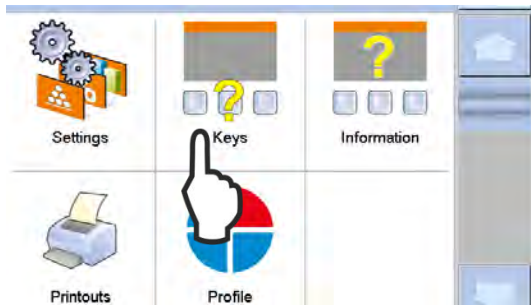

Tap <Keys>

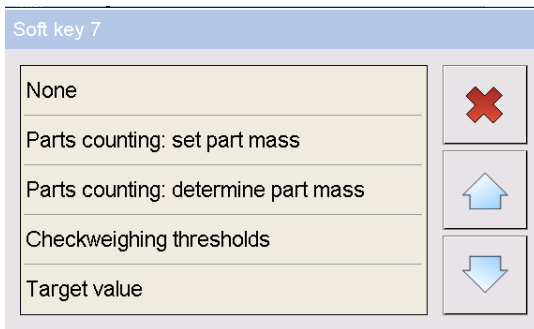

Assign the function <Check weighing thresholds> to the function key.

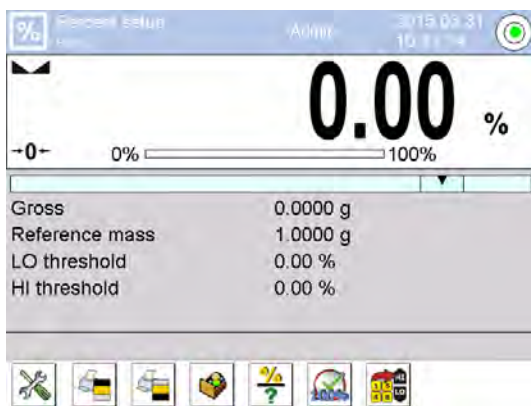

Back to “percentage determination“

window by

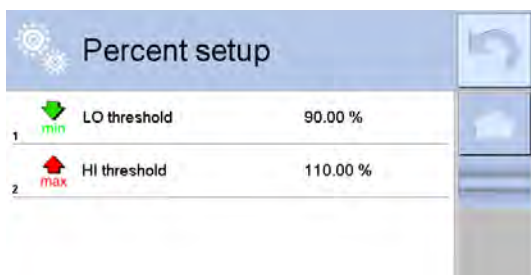

Press the function key to enter the upper and lower limit value in [%] for tolerance control.

Back to “percentage determination“

window by

Percent weighing

- ⇒ For determining reference weight see chap. 14.3.1 or chap. 14.3.2
- ⇒ If required, tare and place load. The weight of the item to be weighed is displayed in percent, with reference to the reference weight.

Sample display

State

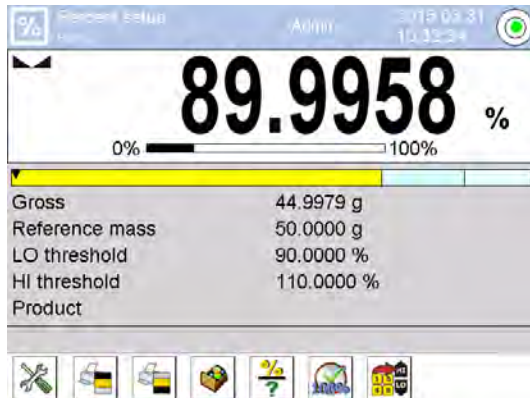

Load below specified tolerance

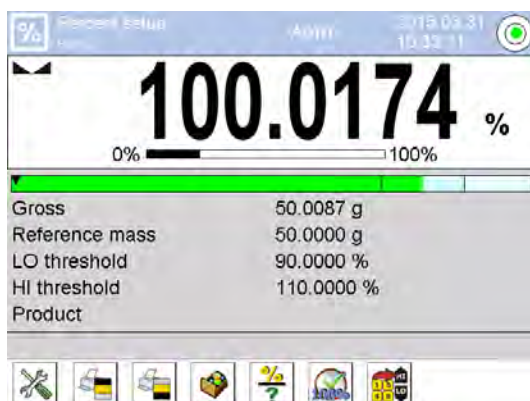

Load within specified tolerance

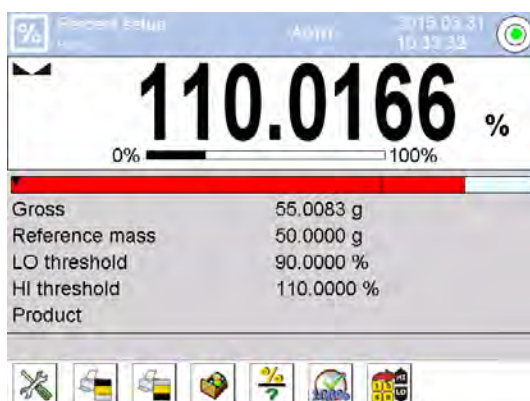

Load exceeds specified tolerance

14.5 Determine initial weight according to target value [%]

This function facilitates determining the initial weight of a sample according to a target value in [%]. The additional entry of \pm tolerance allows you to specify the extent of accuracy to be applied during determining the initial weight of a sample.

Selecting parameters:

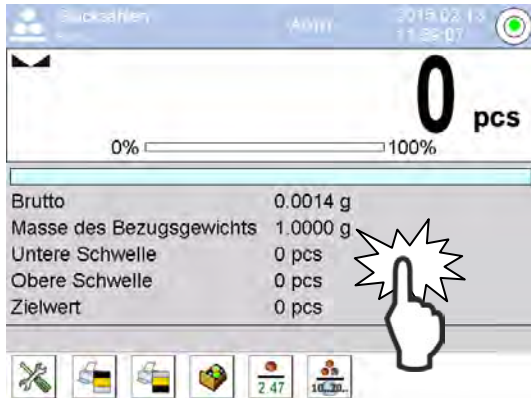

Tap grey info box

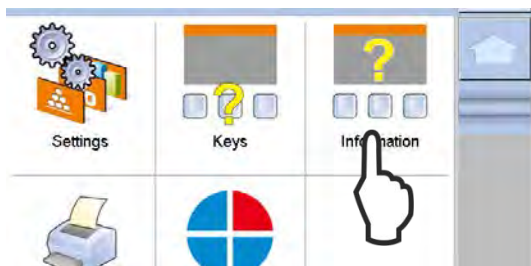

Tap <Information>.



Select bar graph <Yes>.

Select target value <Yes >

Select tolerance <Yes >

Back to the last display by



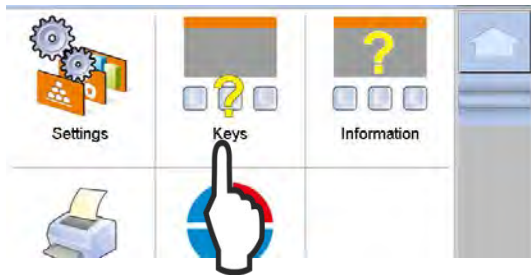

Tap <Keys>

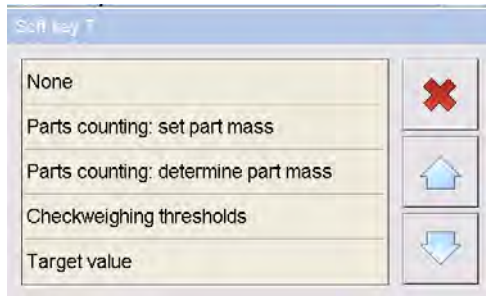

Assign the function "target value" to the function key.

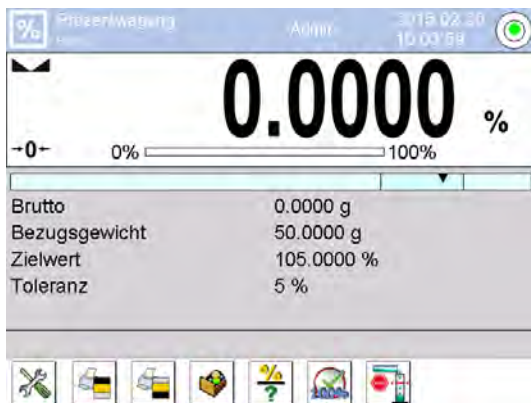

Back to "percentage determination" window by .

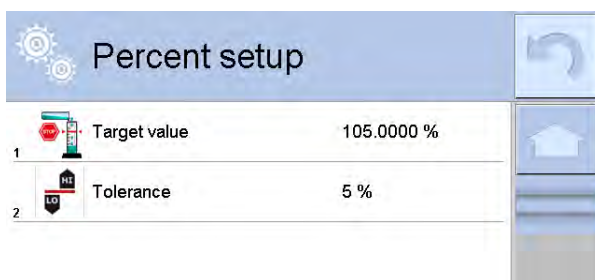

Use the function key  to enter the target value in [%] and, if required, tolerance (selectable 0 - 100%).

Back to "percentage determination" window by .

Percent weighing

- ⇒ For determining reference weight see chap. 14.3.1 or chap. 14.3.2
- ⇒ If required, tare and place load. The weight of the item to be weighed is displayed in percent, with reference to the reference weight. The bar graph facilitates initial weighing according to target weight. The sample may be weighed approximately until the lower tolerance value has been reached and afterwards can be finely dosed up to target value, as required. The target value is marked as ▼ .

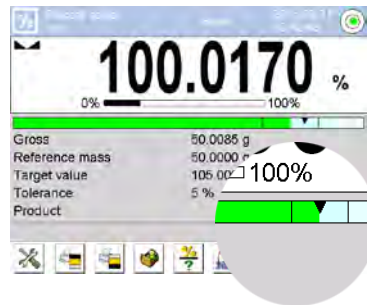

Sample display

State

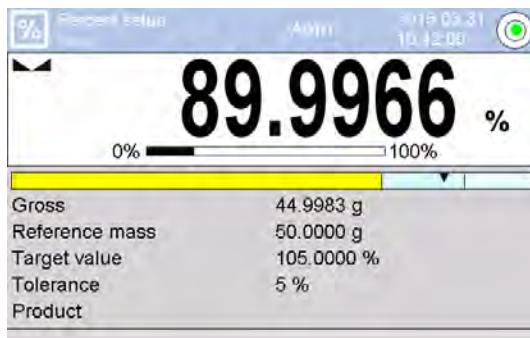

Weighing value below specified target value

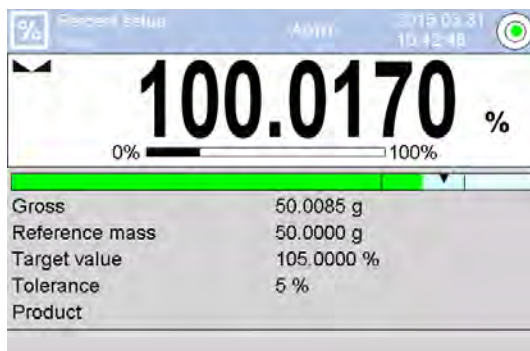

Target value has been reached and is within the specified tolerance

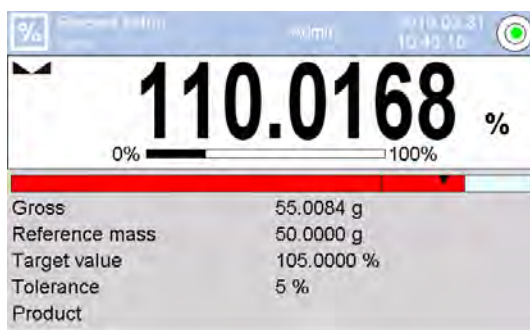



Weighing value exceeds specified target value / tolerance



15 Density determination



We recommend using the optional density determination sets for carrying out density determination for models KERN AET and PET. This contains all the necessary structures and resources for a comfortable and precise determination of the density.

15.1 Selecting an application

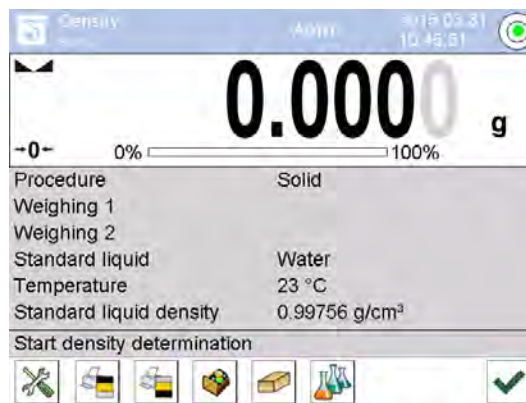

For instance, tap the icon  in the top left corner of the display window and select application density .



The factory configuration provides enabled special function keys

<    > as well as a special info box for percentage determination.

Special function keys:

	Density determination of solids, see chap. 15.2
	Density determination of liquids see chap. 15.3
	Start measurement

Special info boxes:

Sequence of operations	Selected type of density determination (Method “solids“ or “liquids“)
Weighing process 1	Weighing of sample in air
Weighing process 2	Weighing of sample in liquid
Reference liquid	Auxiliary liquid (distilled) water, ethanol or fluid of your choice of known density.
Temperature	Temperature of auxiliary liquid.
Density of	<ul style="list-style-type: none"> ➤ For density determination of solids: Density of auxiliary liquid (for water or ethanol determined automatically from the integrated density tables and then displayed) ➤ For density determination of liquids: Volume of plummet

i	<p>For selecting additional function keys see chap. 10.2.2</p> <p>For selecting additional information texts see chap. 10.2.3</p>
----------	---

15.2 Density determination of solids

For the determination of the density of solids, the solid is first weighed in air and then in the aid liquid, whose density is known. From the weight difference results the buoyancy from where the software calculates the density.

The auxiliary liquids used most often are distilled water or ethanol.

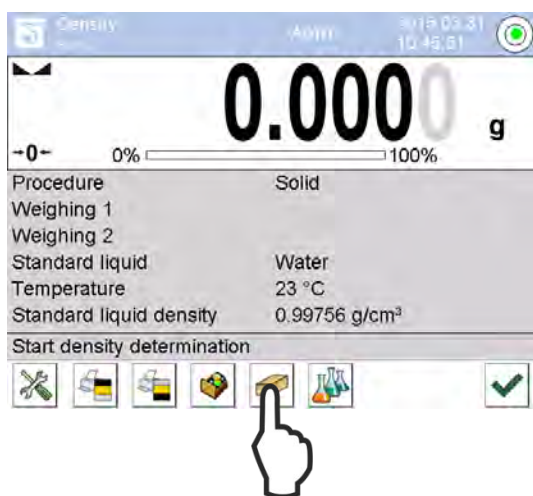

⇒ To select method “solids“, press the function key 

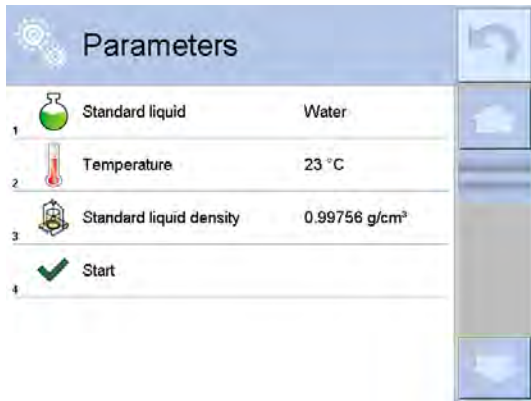

⇒ The parameter menu for the auxiliary liquid will be displayed.



Auxiliary fluid

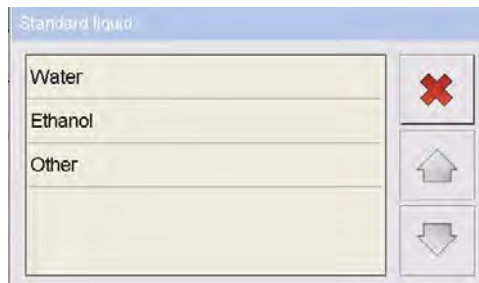

⇒ To select the auxiliary liquid, tap **<Reference liquid>**.

1. When selecting **<Water>** or **<Ethanol>** enter the auxiliary liquid at the next step.
2. When selecting **<Other>** enter the known density for the auxiliary liquid at the next step.



Temperature



When selecting **<Water>** or **<Ethanol>** as auxiliary liquid the temperature is entered during this step.

⇒ Tap **<Temperature>**.

⇒ In the numeric input window

Enter the temperature for the auxiliary liquid in and confirm by 



Density of reference liquid

1. When selecting **Water** or **Ethanol**, their density will be automatically determined from the integrated density tables and displayed:

Parameters

1	Standard liquid	Water
2	Temperature	20 °C
3	Standard liquid density	0.99823 g/cm ³
4	Start	

2. When selecting **Other** tap the **<Density of reference liquid>** command button:

Parameters

1	Standard liquid	Other
2	Temperature	20 °C
3	Standard liquid density	0.99823 g/cm ³
4	Start	

- ⇒ Enter the known density for the auxiliary liquid in the numeric input window and confirm by

Standard liquid density (g/cm³)

0.98773

1 2 3 4 5
6 7 8 9 0
. - + → Back



Press the function key to start density determination.

15.2.1 Determine density of sinking solid bodies ($d > 1 \text{ g/cm}^3$)

1. Remove the immersion basket and place the glass beaker filled with the auxiliary liquid in the centre of the platform. Filling height should be approx. $\frac{3}{4}$ of the capacity. Make sure that it has no contact with the frame. Remount the immersion basket. Make sure that it does not touch the glass beaker. Set balance to zero.

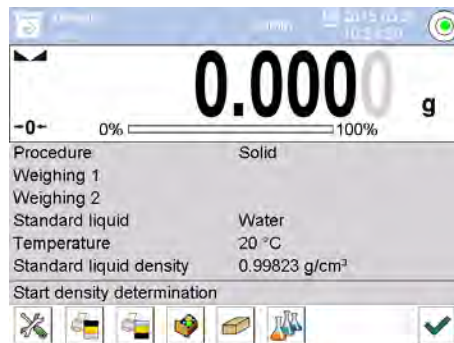

2. Place solids in the upper sample dish.



Fig.1: Density determination set YDB-03 “weighing in air”
The weight of the „sample in air“ is displayed.

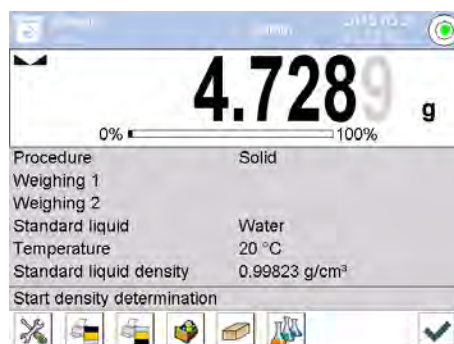

3. Wait for stability display and confirm by . The weight value "sample in air" will be displayed under <weighing process 1>.

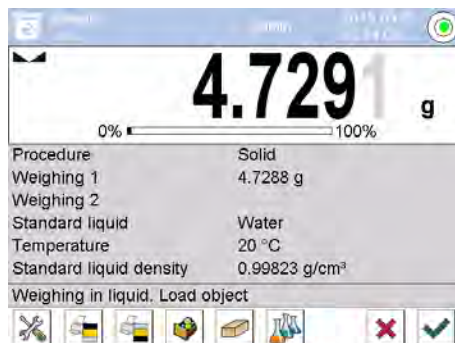

4. Place solids in the lower filter dish.
For this remove the immersion basket out from the frame. Always ensure that, when re-immersing into the liquid, no additional bubbles adhere; it is better to use pincers to place the sample directly on the sifting bowl. Make sure that the sample is at least 1 cm immersed.



Fig. 2: Density determination set YDB-03 "weighing in auxiliary liquid"

5. Wait for stability display and confirm by . The weighing scale first determines, then displays the solid matter's density.

6. When connecting an optional printer, the result will be printed out. Printout example see chap. 15.4.
7. Finish process by . Remove the sample. Start more measurements at step 2.



To avoid corrosion damage, don't leave the immersion basket immersed in liquid for a long time.

15.2.2 Determine density of floating solid bodies ($d > 1 \text{ g/cm}^3$)

At solid material with density less than 1 g/cm^3 , a density determination with two different methods is possible.

Method 1:

Implementation see chap. 15.2.1

As aid liquid is used a liquid with less density than that of the solid material, e.g. ethanol approx. 0.8 g/cm^3 .

This method should be applied when the density of the solid is just slightly different from that of the distilled water.

Using ethanol is not recommended, when the solid material is being attacked.



When working with ethanol, you must observe the applicable safety regulations.

Method 2:

Implementation see chap. 15.2.1, for "step 4" place sample **underneath** instead of in the filter dish.

15.3 Determining density of liquids

At the density determination of liquids, a plummet is used whose density is known. The plummet is weighed first in air and then in the liquid whose density is to be determined. From the weight difference results the buoyancy from where the software calculates the density.

The density of the enclosed steel plummet can be determined as described in chap. 15.2.1 and its volume can be calculated according to the following formula:

$$V = \frac{M}{\rho}$$

- V = Volume of the plummet
- M = Weight of the sample in air
- ρ = Plummet density

Or quickly and inexpensively in our calibration laboratory. Further information is available on KERN-Homepage (www.kern-sohn.com).

For the determination of the density of solids, the solid is first weighed in air and then in the aid liquid, whose density is known. From the weight difference results the buoyancy from where the software calculates the density. The auxiliary liquids used most often are distilled water or ethanol.

Preparation:

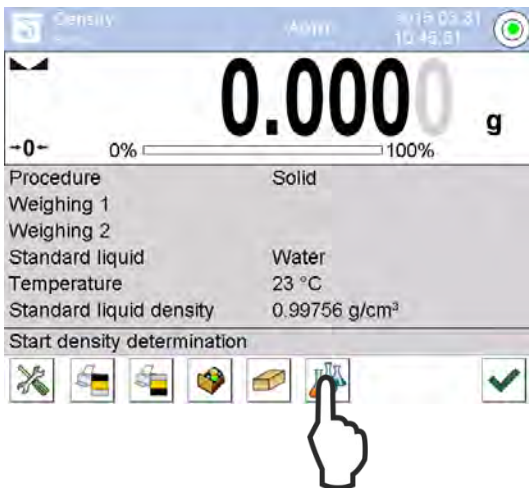

⇒ To select method “liquid“ press the function key 

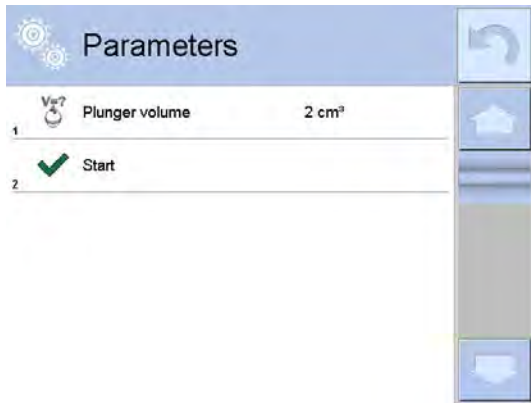

⇒ You will see the display used to enter the plummet volume.



Volume of plummet



⇒ Tap < **Volume of plunger** >.
Enter volume for plummet and confirm by ✓.



Press the function key to start density determination.

Determining density of the test liquid

1. Fill test liquid into the glass beaker.
2. Put the plummet into the upper sample bowl.



Fig.1: Density determination set YDB-03 “weighing in air“
The weight of the plummet in air will be displayed.

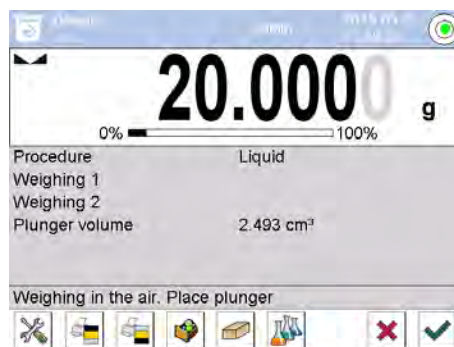

3. Wait for stability display and confirm by . The weighing value for “plummet in air” will be displayed under <weighing process 1>.

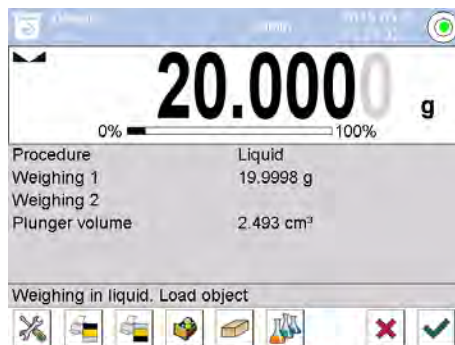

4. Put the plummet into the lower sifting bowl.



Fig. 2: Density determination set YDB-03 “weighing in test liquid“

5. Wait for stability display and confirm by . The weighing balance will first determine then display the fluid's density.



6. When connecting an optional printer, the result will be printed out. Printout example see chap. 15.4.
7. Finish process by . Remove the sample. Start more measurements at step 1.

15.4 Log density determination

Printout examples default report (KERN YKB-01N):

1. Density determination of solids

----- Density -----	
----- Solid -----	
Operator	Admin
Balance ID	132012
Date	2015.03.05
Time	11:12:30
Standard liquid	Water
Temperature	20°C
Standard liquid density	0.99823 g/cm ³
Weighing 1	6.757 g
Weighing 2	4.999 g
Density	3.836769 g/cm ³

Signature	
.....	

2. Determining density of liquids

----- Density -----	
----- Liquid -----	
Operator	Admin
Balance ID	132012
Date	2015.03.05
Time	11:12:30
Plunger volume	2.493 g/cm ³
Weighing 1	20.001 g
Weighing 2	17.000 g
Density	1.203771 g/cm ³

Signature	
.....	

If a measurement report is printed, the data record will automatically be saved to the database under **<Density reports>**.

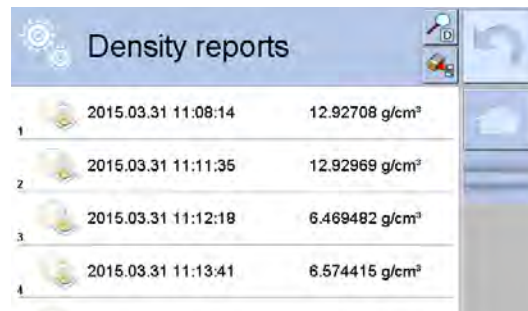
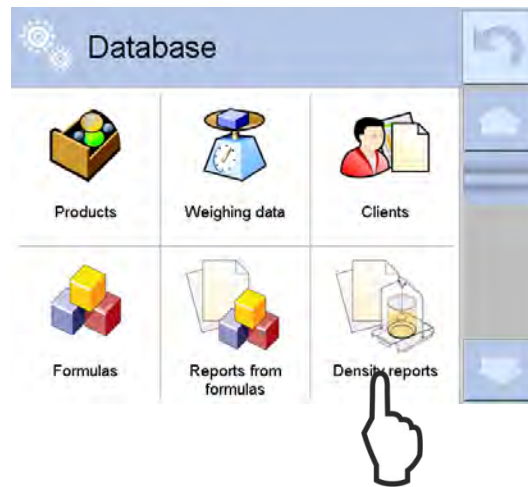

To **<Open/Print>** press and hold your finger on the desired data record until the context menu appears.

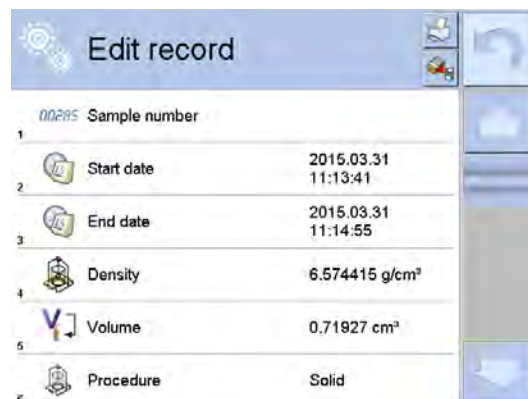
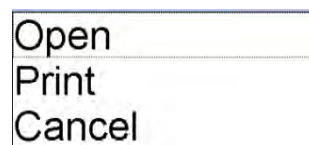





16 Animal weighing



This function is used to weigh unstable loads such as live animals. There are two different start / reset modes:

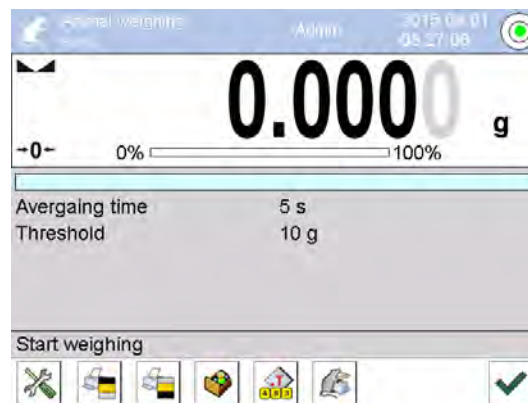

- **Manual** (per keystroke)
- or
- **Automatic** (automatic start after exceeding minimum weight).

16.1 Selecting an application

For instance, tap icon  in the top left corner of the display window and select application animal weighing  function.



The factory configuration includes two enabled special function keys < ,  > as well as a special info box for animal weighing.

	For selecting application specific settings see chap. 16.3.1
	Start / stop measuring cycle (only shown when set to “manual start”; see chap. 16.3.2)

	For selecting additional function keys see chap. 10.2.2 For selecting additional information texts see chap. 10.2.3
---	--

16.2 Selecting parameters

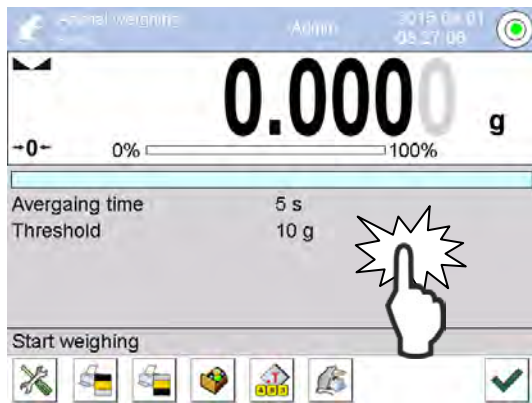

Tap grey info box

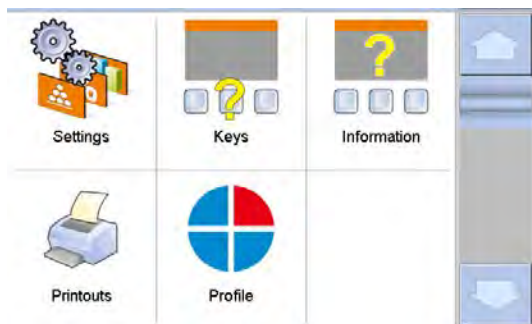

The menu will appear.

Individual menu items can be called and changed by tapping the icons.

- Settings, see chap. 12.2.1
- Keys/buttons, see chap. 10.2.2
- Information texts, see chap. 10.2.3
- Printouts, see chap. 10.2.4
- Profile, see chap. 10.2.5

16.3 Start animal weighing

16.3.1 Previous adjustments

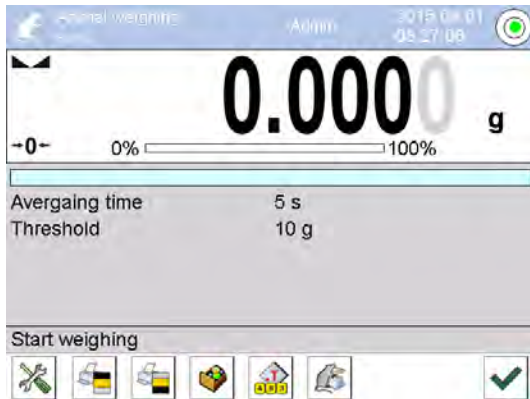

⇒ Press function key 

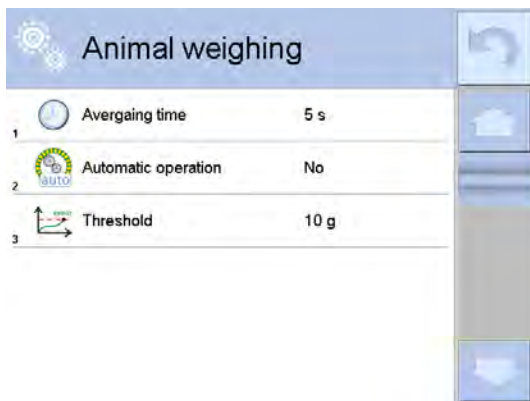

⇒ The defaults menu will appear.
Averaging period
Auto start / manual start
threshold

1. Averaging period

Duration of measuring cycle that the weighing scale uses to calculate the mean value.

2. Auto start / manual start

Auto start:

The measuring cycle will start automatically when the load has been placed and exceeded the specified threshold (minimum weight).

Manual start:

The measuring cycle must be started manually. Placing and removing of load must be confirmed by .

3. Threshold

Determining a minimum weight after which, when exceeded, the measuring cycle will start

16.3.2 Animal weighing using manual start

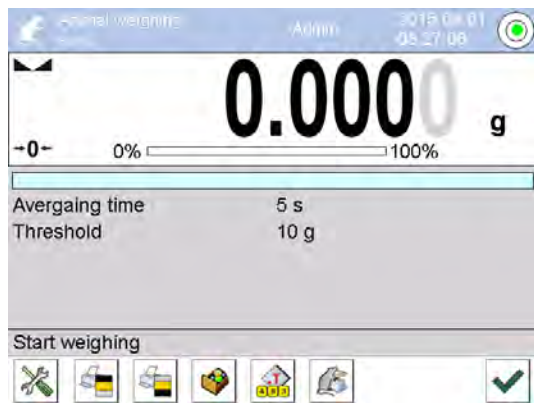

⇒ If a weighing container is used, tare by pressing the **TARE** key.

⇒ Place the load and start the measuring cycle by .



⇒ The bar graph will show the progress of the measuring cycle.

⇒ To cancel measuring, press .



⇒ The result will be displayed.

⇒ Remove load and confirm by . Then the balance is ready for further measurements.

16.3.3 Animal weighing using automatic start

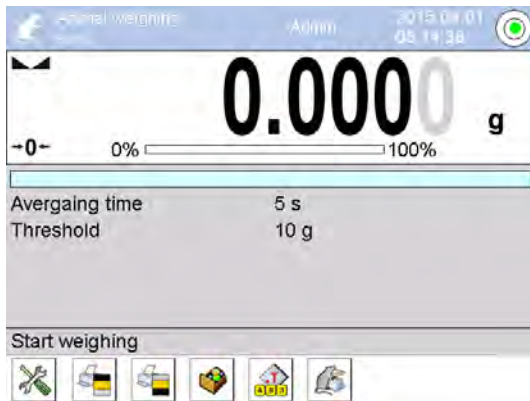

- ⇒ If a weighing container is used, tare by pressing the **TARE** key.
- ⇒ Place load and the measuring cycle will be started automatically after the threshold has been reached.

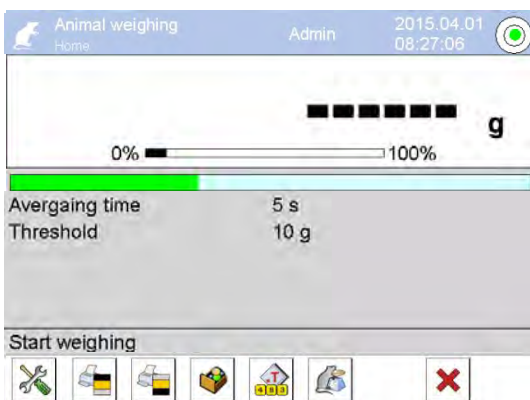

- ⇒ The bar graph will show the progress of the measuring cycle.
- ⇒ To cancel measuring, press .

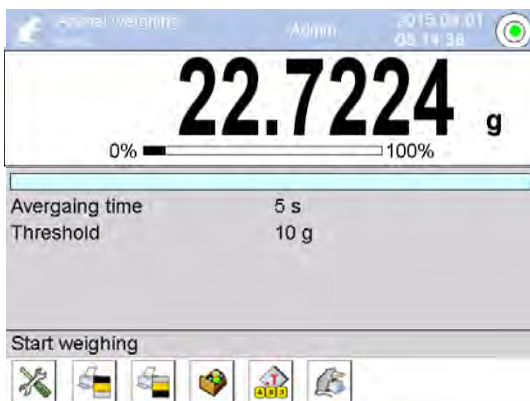

- ⇒ The result will be displayed.
- ⇒ Remove load.
Then the balance is ready for further measurements.



17 Formulation

This function is used to determine the initial weight of several interrelated components sequentially.

The weighing values of all individual components as well as the total result will be recorded and can be logged.

“Formulation“ has two modes available:



1. Formulation without using database (“free Formulation”)

2. Formulation based on database

You can store complete formulas including all ingredients and the related parameters (such as name, tolerances, tare weights) in the database. When processing such a formula from the database, the weighing scale will guide you step by step through the process of determining the initial weight of components.







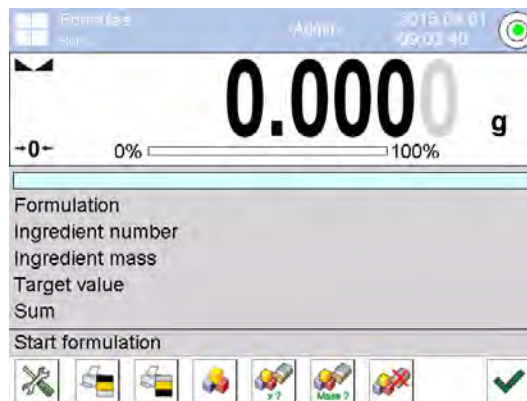

In the case of excess weight for an ingredient the convenient recalculating function will automatically determine the new target weights for the other ingredients.

17.1 Selecting an application

For instance, tap the icon  in the top left corner of the display window and select application Formulation  .



The factory configuration includes the enabled function keys below as well as a special info box for Formulation.

	Invoke a menu, see chap. 8
	Print header
	Print footer
	For processing a formula from the formula database see chap. 17.5
	Multiplication factor
	Weighing formula from the database according to target value see chap. 17.6
	Free Formulation - without using the formula database see chap. 17.3
	Confirm

i	For selecting additional function keys see chap. 10.2.2 For selecting additional information texts see chap. 17.2.2
----------	--

17.2 Selecting parameters

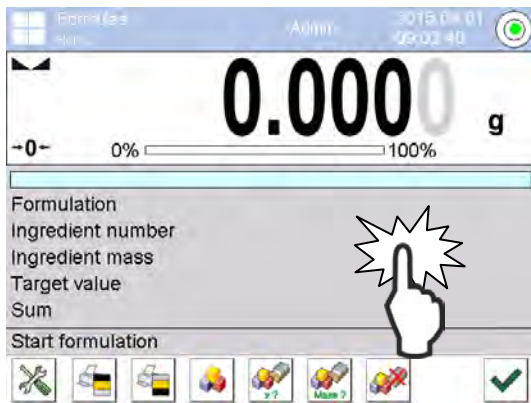

Tap grey info box

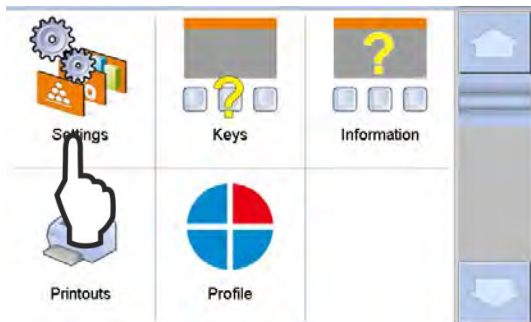

The menu will appear.

Individual menu items can be called and changed by tapping the icons.

- Settings, see chap. 17.2.1
- Keys/buttons, see chap. 10.2.2
- Information texts, see chap. 17.2.2
- Printouts, see chap. 17.2.3
- Profile, see chap. 10.2.5



17.2.1 Settings

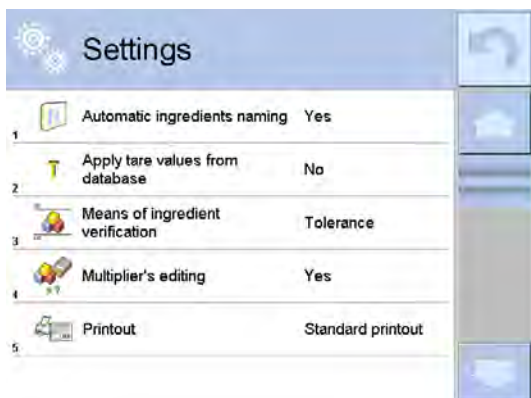

The available settings will be displayed.

To call and change individual settings tap the icons.



Show name of ingredient automatically, options **yes / no**



Apply tare value assigned to product from product database, options **yes / no**



Determination of initial weight control for ingredients

➤ **Tolerance**

The default value for determining the initial weight is the desired percentage value of every ingredient in relation to the total weight of the formula.

➤ **Threshold**

The definition of an upper and lower limit value (lower / upper threshold) ensures that the weighed ingredient remains exactly within the set tolerances.



Multiplication factor, option **yes / no**

When **<yes>** is selected, you will be asked to specify by how many multiples the amount of formula is to be created (such as double the amount = factor 2). The desired weights to be measured for the ingredients will then be adjusted accordingly.



For selecting a default report or user defined report see chap. 17.2.3



17.2.2 Information texts

Based on factory settings, the following information texts will be displayed during Formulation:

- Formula
- Number of ingredient
- Weight of ingredient
- Target value
- Sum

Bar graph display

The bar graph display facilitates determining the initial weight of ingredients. The additional entry of \pm tolerance allows you to specify the extent of accuracy to be applied during determining the initial weight of a sample.

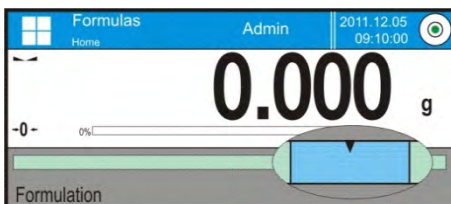

Initial weight determination control "tolerance" see chap.17.2.1

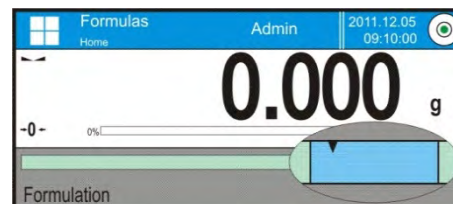

Initial weight determination control "threshold" see chap. 17.2.1

Enable bar graph display:



Tap <Information>.

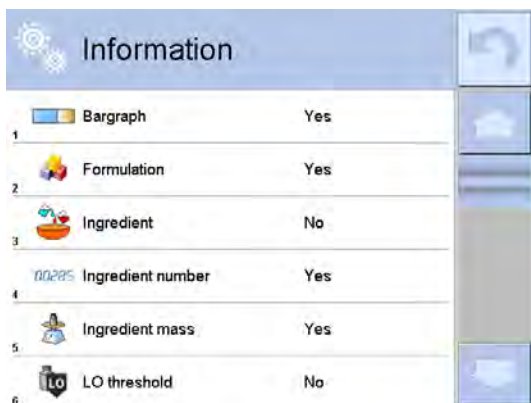

Select bar graph setting <Yes>.
To display additional information texts
select setting <Yes>.

Back to last display by





17.2.3 Printouts

This function is used to determine which information is to be printed.

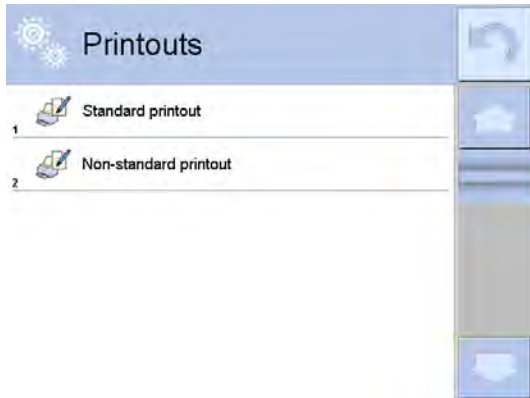

Select default or user defined report.

1. <Default report>

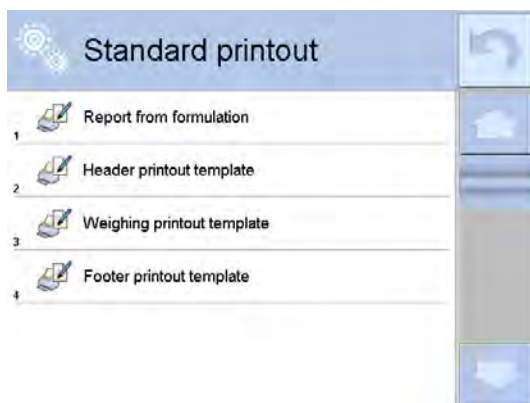

Tap **<Report from formulation>**.

Any information accepted with **<yes>** will be printed.

Additional settings for

<Print preview for header>

<Print preview for weighing process>

<Print preview for footer>

(see chap. 10.2.4)

2. User defined report

You can define individual texts and variables for the report.



Tap key  **<Add>**

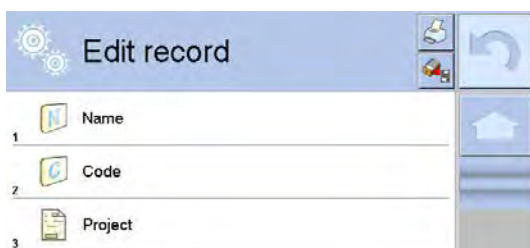

For further information about the processing of data records see chap. 10.2.4

17.3 Free Formulation (without using formula database)

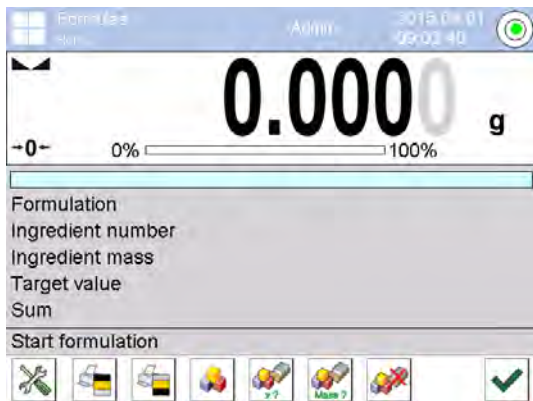

⇒ Tare when using a weighing container.

⇒ Press function key 



⇒ Enter name in the displayed editing window for the formula and confirm by 

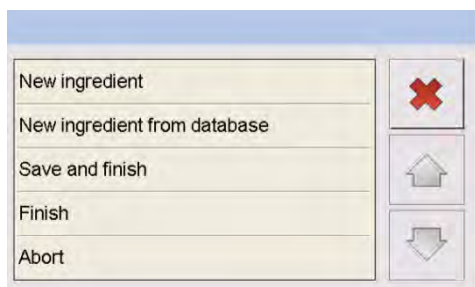

⇒ The program will go automatically to the ingredient menu

Select new or ingredient from product database



⇒ When selecting **<New ingredient>** enter name for the first ingredient and confirm by 

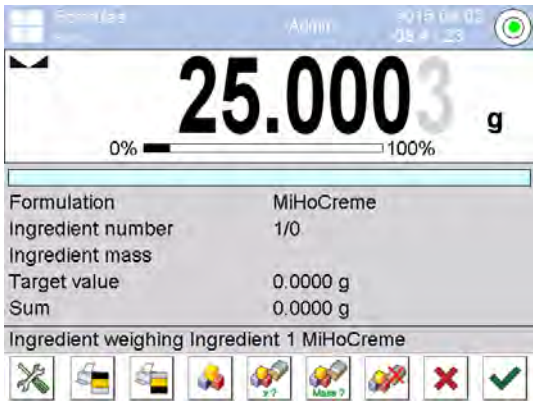

⇒ Weigh in the first ingredient and confirm by  .

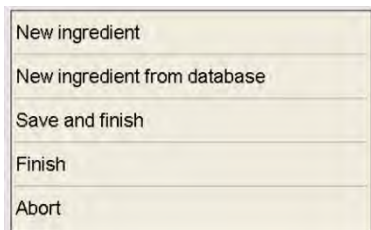



⇒ The program will automatically go to the menu for the second ingredient.

Select new or ingredient from the product database.

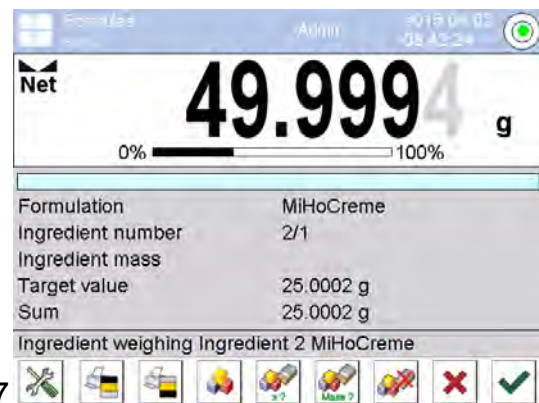

⇒ When selecting < new ingredient > enter the name for the second ingredient and confirm by  .



⇒ Weigh in the second ingredient and confirm by  .

⇒ For further ingredients repeat this sequence of operations.

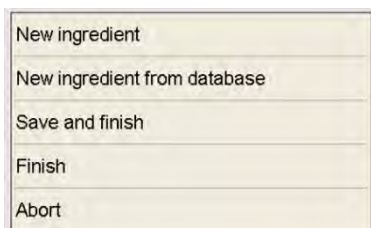

⇒ When all ingredients have been weighed in **either** select **<Cancel>** without saving the formula



or

<Save and finish>

17.4 Defining formula in database

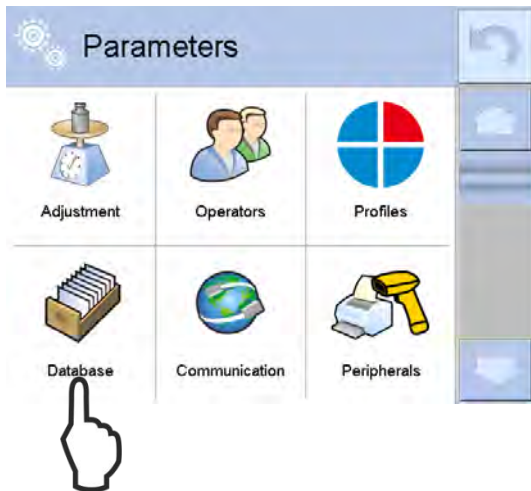
Call formula database:



⇒ Call up menu with  or 

⇒ Tap <Database>.



⇒ Tap <Formulas>

Define new formulas:



⇒ To add a new data record, tap < >.



⇒ The selection list will appear. Individual settings can be called and changed as follows by tapping individual icons:



1. Name

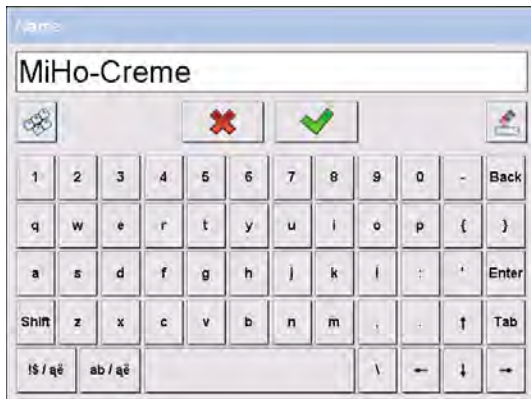

- ⇒ In the selection list tap **<Name>**.
- ⇒ The alphanumeric input window will appear.
- ⇒ Enter name of formula and confirm by .



2. Code



- ⇒ In the selection list tap **<Code>**.
- ⇒ The alphanumeric input window will appear.
- ⇒ Enter code of formula and confirm by .



3. Ingredients

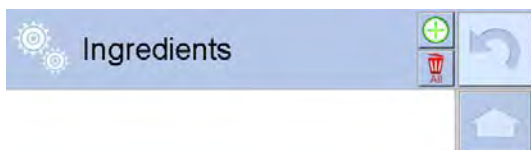

- ⇒ In the selection list tap **< Ingredients >**.
- ⇒ To add an ingredient tap **<  >**.

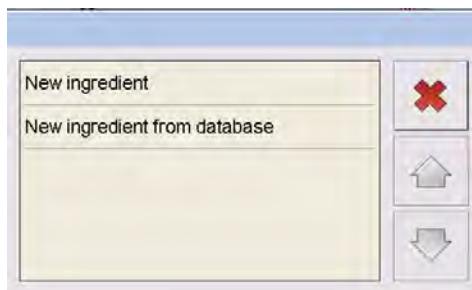

- ⇒ Select new or ingredient from product database.

Define parameters for first ingredient (such as milk):



⇒ When selecting **<New ingredient>** enter name for the first ingredient and confirm by

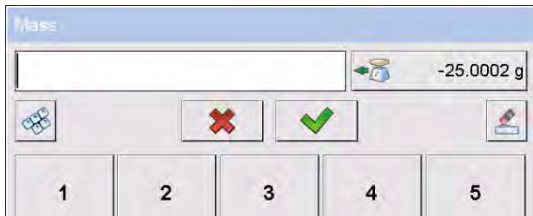

⇒ Enter desired weight for ingredient and confirm by .

Define parameters for additional ingredient as described above for first ingredient.



⇒ Once all ingredients for the formula have been defined press to return to menu

or

define weighing in tolerances for the ingredients as described below:

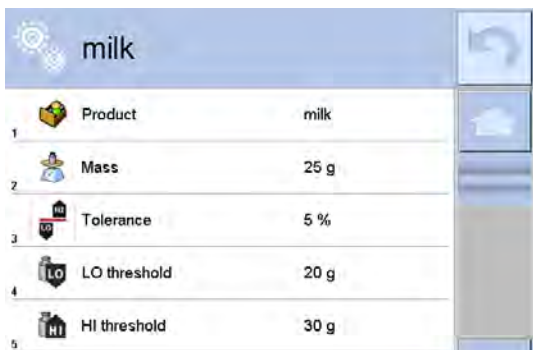

⇒ Tap ingredient and define desired limit values.



Return to menu by .

⇒ The number of ingredients **00285** and the total weight are displayed.

17.5 Process formula from database

Condition: Formula is already defined in database; see chap. 17.4.
or
saved under “free Formulation“; see chap.17.3.

For **Settings for display example see chap.** Fehler! Verweisquelle konnte nicht gefunden werden.:

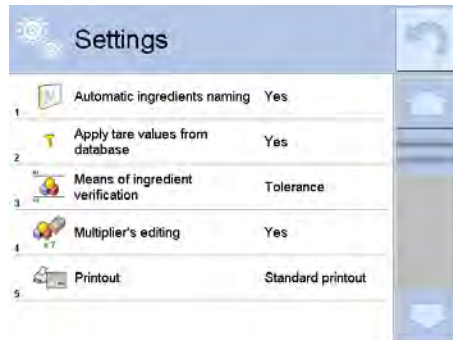

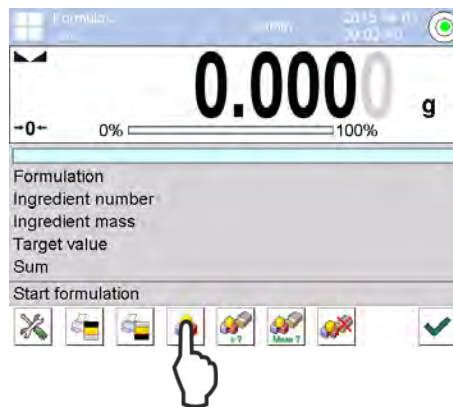

Procedure:

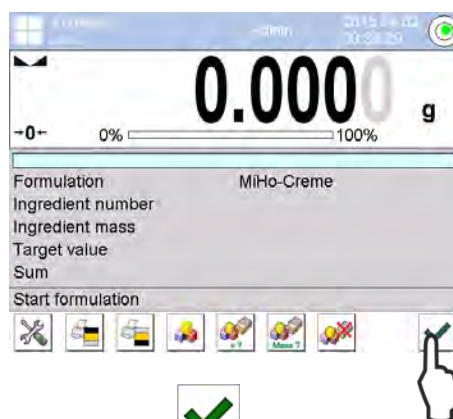

1. Press function key  and select desired formula such as MiHo cream (see chap. 17.4) from the database.



2. Start processing the formula by 

3. When pressing  or when the function is enabled **<Multiplier's editing ▶ yes>** (For setting see chap. 17.2) there will be a query asking you to enter by how many multiples the amount the formula is to be created (such as double the amount = factor 2). The desired weights to be measured for the ingredients will then be adjusted accordingly.



4. The weighing scale is ready for weighing in the first ingredient. The number of the ingredient and its desired weight will be displayed in the info box.

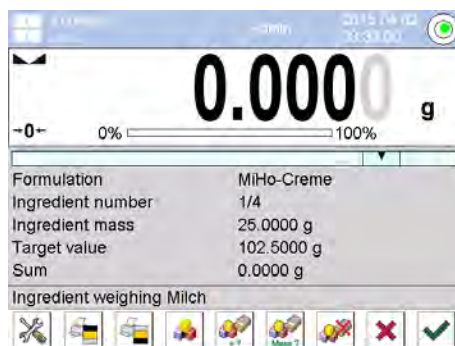

5. Place the weighing container and tare it by pressing **TARE**.
6. Determine the initial weight of the first ingredient. The graphic weigh-in assistant providing tolerance markers facilitates determining the initial weight according to the desired value. The sample may be weighed approximately until the lower tolerance value has been reached and can be finely measured out up to target value, as required. The target value is marked as ▼.

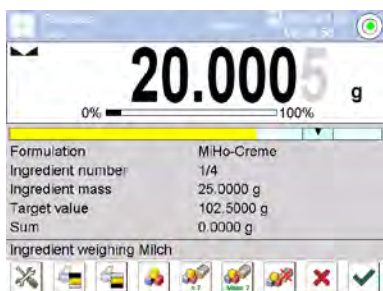

Determined initial weight of ingredient is below desired value

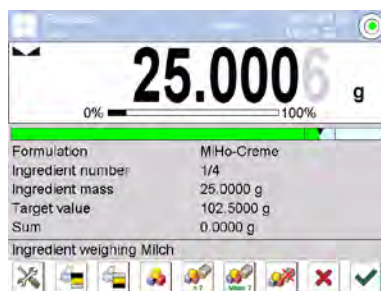

Determined initial weight of ingredient has reached the desired weight and is within tolerances.

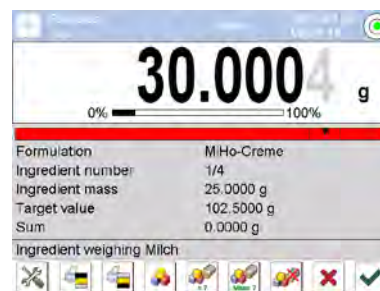

Determined initial weight of ingredient exceeds desired value

7. Confirm the achieved desired weight by . The display will automatically be reset to zero.

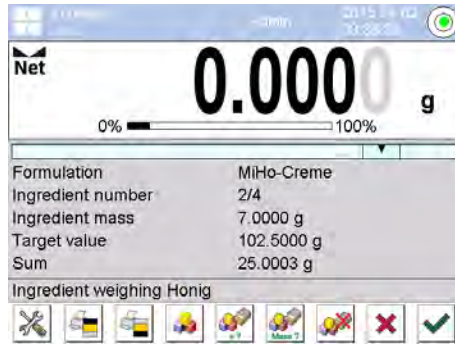

8. The weighing scale will now be ready for determining the initial weight of the second ingredient.
9. Determine the initial weight for additional ingredients by following the sequence of operations above.
10. Upon confirming the last ingredient, the result of the formula will be displayed automatically.

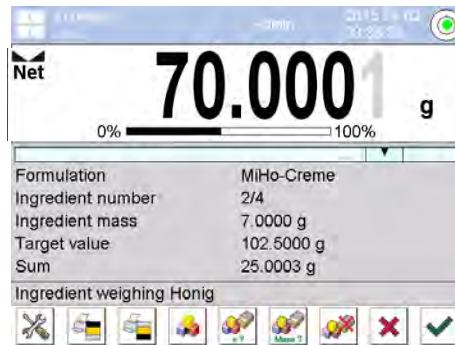

If an optional printer is connected, a measurement record will be produced. For printed example see chap.17.7.

11. Finish formula by . You can now start a new formula.

Recalculating function:

Confirming an exceeded desired weight with will result in the following query:
 < Do you want to recalculate the formula? >:

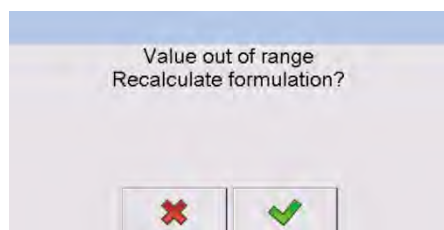

After confirmation by the new desired weights of the other ingredients will be calculated proportionally to the exceeded weighing value.

17.6 Weigh in formula from database according to target value

Condition: Formula is already defined in database; see chap. 17.4.
or
saved under "Free Formulation"; see chap. 17.3.

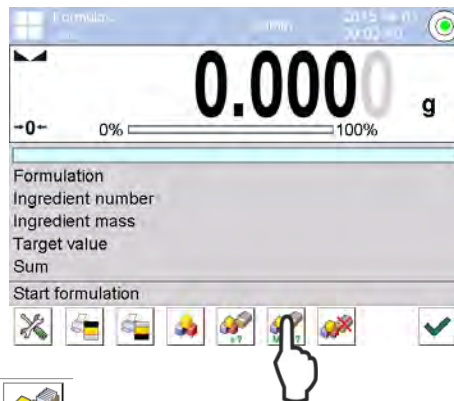

⇒ Press function key  and select desired formula such as MiHo cream (see chap. 17.4) from the database.

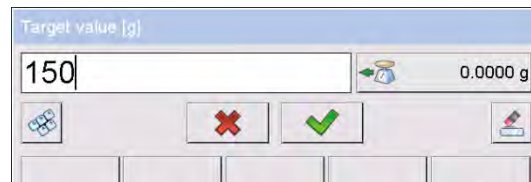
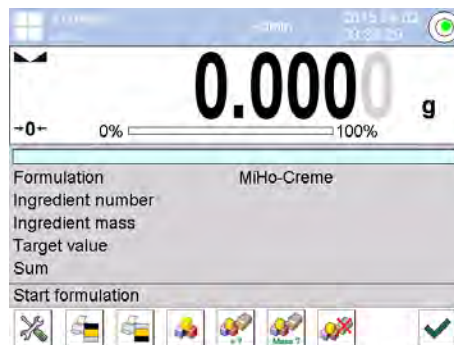

⇒ Enter target value for desired total weight and confirm by . The desired weights to be measured for the ingredients will then be adjusted accordingly.

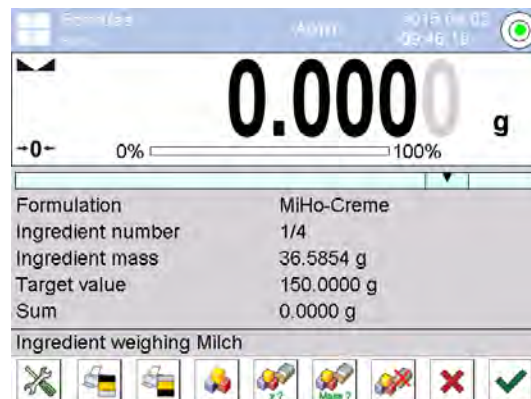

⇒ For how to process a formula see chap. 17.5, step 4 -11.

17.7 Logging formulas

Printed example default report (KERN YKB-01N):

----- Formulas -----	
Operator	Admin
Formulation	Mi-Ho-Creme
Start date	2015.03.05 11:06:54
End date	2015.03.05 11:11:29
Quantity of ingredients	5
Number of measurements	5
----- Measurement 1 -----	
Net	19.994 g
----- Measurement 2 -----	
Net	49.993 g
----- Measurement 3 -----	
Net	9.999 g
----- Measurement 4 -----	
Net	1.001 g
----- Measurement 5 -----	
Net	19.995 g
Target value	101.000 g
Sum	100.982 g
Formulation difference	-0.018
Status	OK

Signature	
.....	

The moment a measuring report is printed, the data record will be saved automatically to the database under **<Reports from formulas>**.

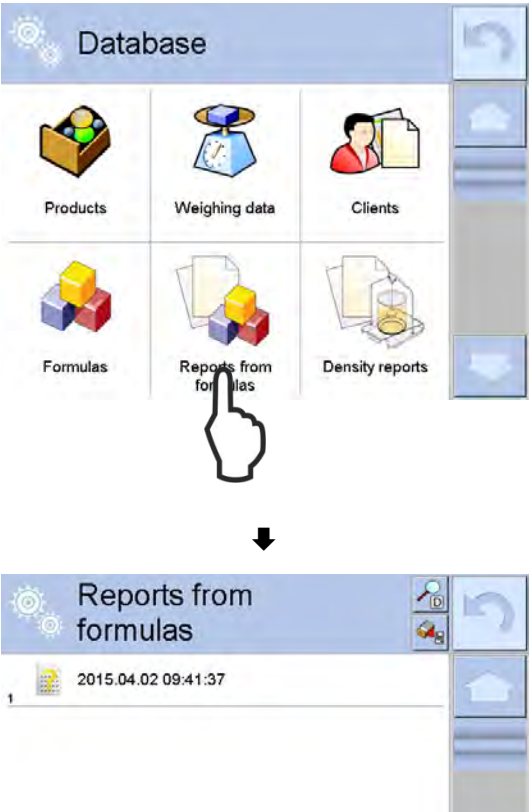

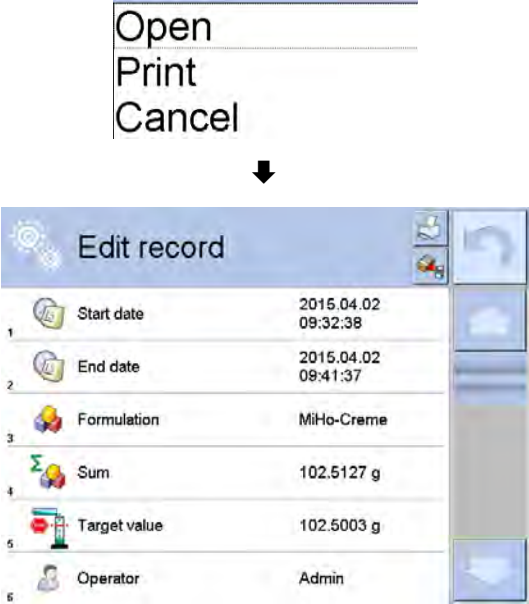

To **<Open/Print>** press and hold your finger on the desired data record until the context menu appears.







18 Statistics

18.1 Selecting an application

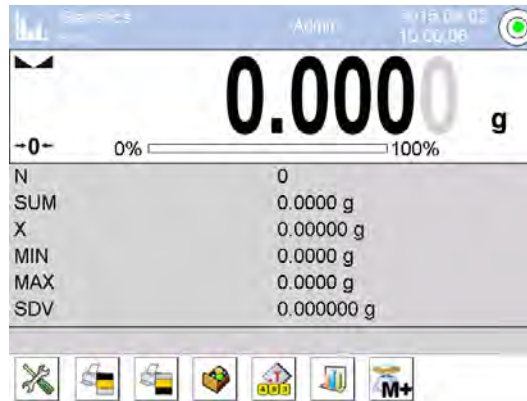

For instance, tap the icon  in the top left corner of the display window and select application statistics .



The factory configuration provides two enabled special function keys

<   > as well as a special info box for percentage determination.

Special function keys:

	Select settings for statistical returns
	Apply current, stable weighing value in statistics
	Apply current, stable weighing value in statistics and print out

Special info boxes:

N	Number of weighed in samples
SUM	Total of weight values
X	Average weight for all samples
MIN	Smallest measured value for current series of measurements
MAX	Greatest measured value for current series of measurements
SDV	Standard Deviation
i	For selecting additional function keys see chap. 10.2.2 For selecting additional information texts see chap. 10.2.3

18.2 Selecting parameters

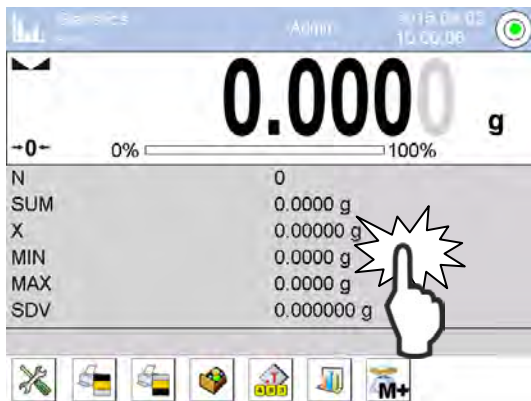

Tap grey info box

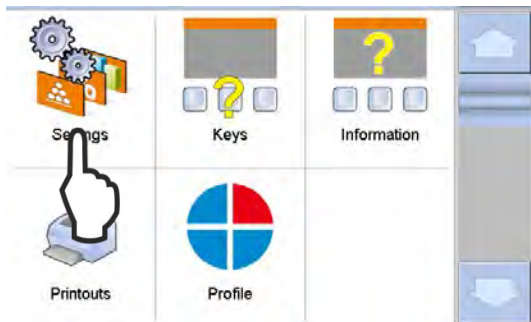

The menu will appear.

Individual menu items can be called and changed by tapping the icons.

- Settings, see chap. 10.2.1
- Keys/buttons, see chap. 10.2.2
- Information texts, see chap. 10.2.3
- Printouts, see chap. 10.2.4
- Profile, see chap. 10.2.5

18.3 Settings for statistical returns

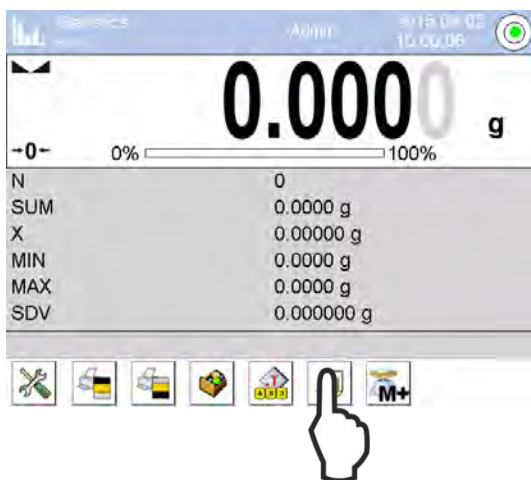

⇒ Press function key





The available settings will be displayed.

To call and change individual settings tap the icons.



View result



Print out report



Delete last weighing value of series of measurements



Delete all statistical information



Diagram for series of measurements

Example:

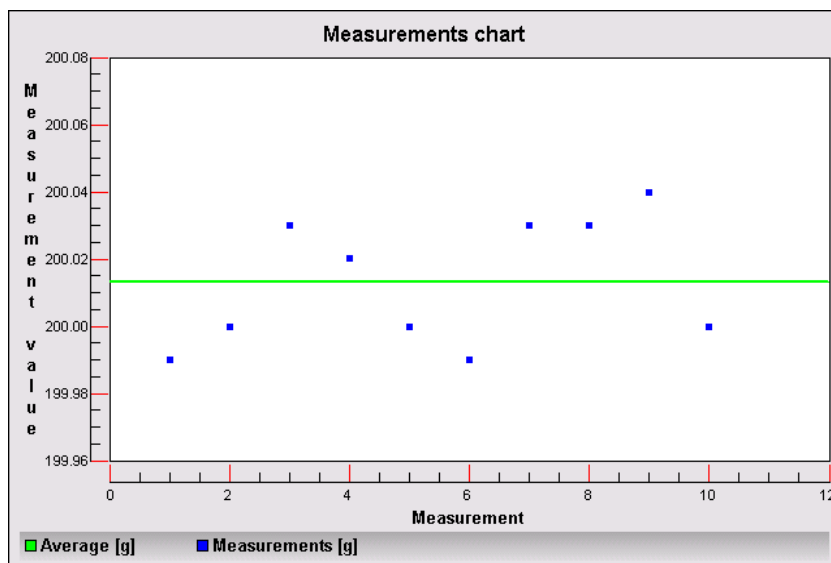
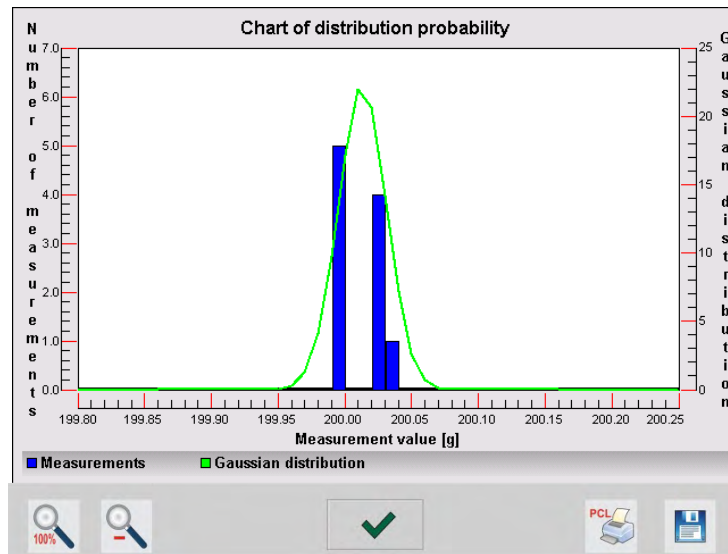



Diagram for probability distribution

Example:



The lower bar underneath the diagram allows you access to the following options:



View entire diagram



Zoom in



Back to last window



Printout of diagram if optional printer (Type PCL) is connected



Save diagram as file (*.bmp) to external data carrier via USB port.





19 Pipette calibration

This function is used to check the accuracy values for pipettes (single-channel or multi-channel) by carrying out a weight analysis. This takes place either according to the requirements of ISO 8655 or user defined. The software contains a database listing manufacturer specifications for various types of pipettes.





- Control the temperature of the pipette, pipette points, sample dishes and test liquids (such as water until constant temperature has been achieved. The standard recommends keeping to a warming-up time of at least 2 hours.
- For that purpose the ambient temperature should be within a range of 20 – 25°C with an air humidity of 50 – 75 %.
- When selecting water as test liquid, use distilled water.
- Maximal 5 values are available for the selection of pipettes with variable volumes.
- Define the type of pipette to be used and the parameters for calibration in the database < Pipettes > before starting the calibration process; see chap. 19.3.

19.1 Selecting an application

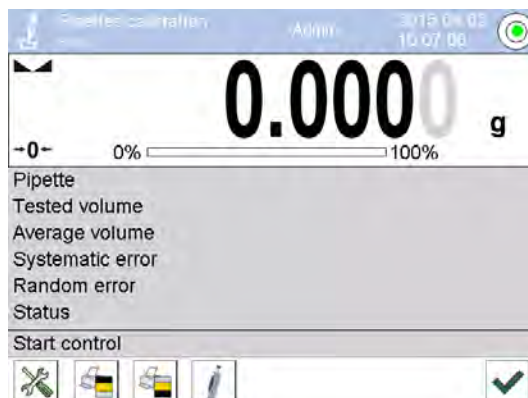
For instance, tap icon  in the top left corner of the display window and select application pipette calibration .



The factory configuration provides enabled special function keys <   > as well as a special info box for percentage determination.

Special function keys:

	Select type of pipette: After selecting a type of pipette the corresponding specifications will become immediately available.
	Start / confirm calibration

Special info boxes:

Pipette	Type of pipette
Test volume	Desired test volume for test cycle
Average Volume	Average value for volumes determined during the test cycle
Systematic error [ES]	Deviation of mean value from desired value [%]
Random error [SR]	Repeatability [μ l] (One measure for repeatability is standard deviation)
Status	Positive / negative

i	For selecting additional function keys see chap. 10.2.2 For selecting additional information texts see chap. 10.2.3
----------	--

19.2 Selecting parameters

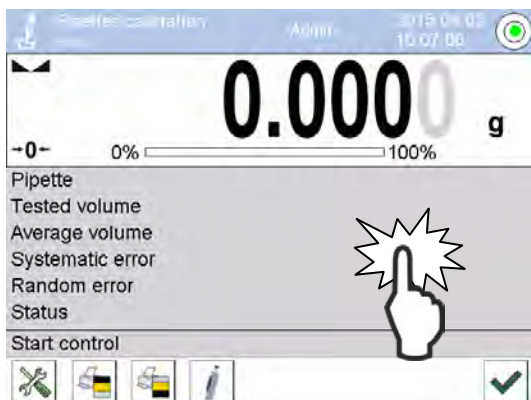

Tap grey info box



The selection list will appear.

Individual menu items can be called and changed by tapping the icons.

- Settings, see chap. 19.2.1
- Keys/buttons, see chap. 10.2.2
- Information texts, see chap. 10.2.3
- Printouts, see chap. 10.2.4
- Profile, see chap. 10.2.5

19.2.1 Settings

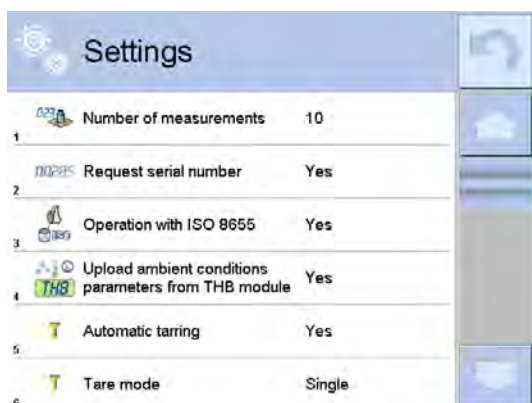

The available settings will be displayed.

To call and change individual settings tap the icons.



1

Number of measurements, options 2-99.



2

Query serial number, options yes / no.



3

Operation according to requirements of ISO 8655, options yes / no.
If set to <Yes> the program will automatically assume the values of errors as per ISO 8655 during pipette calibration.



4

Load ambient conditions (air pressure, temperature) from the optional THB module (not available at the moment).

Yes The current data (temperature / air pressure) will be applied from the THB module during measuring and saved (Model AET 200-5DM only).

No Current data must be determined and entered externally (all models except AET 200-5DM).



5

Automatic taring, options yes / no



6

For selecting tare mode see chap. 10.2.1



7

For automatic printout of footer see chap. 10.2.1



8

For manual / automatic data output see chap. 10.2.1





9

For default report / user defined report see chap. 10.2.1

19.3 Defining pipette in database

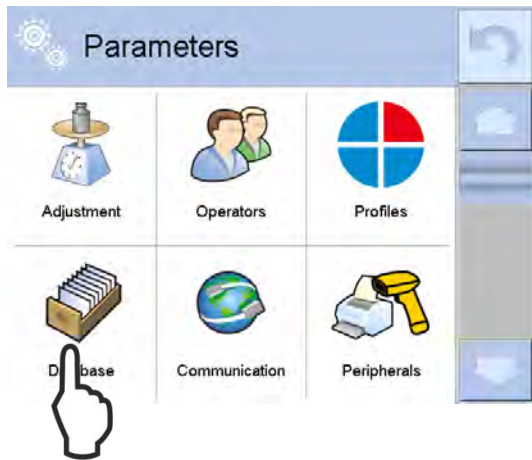
Call database <Pipette>:



⇒ Call up menu with  or 

⇒ Tap <Database>.

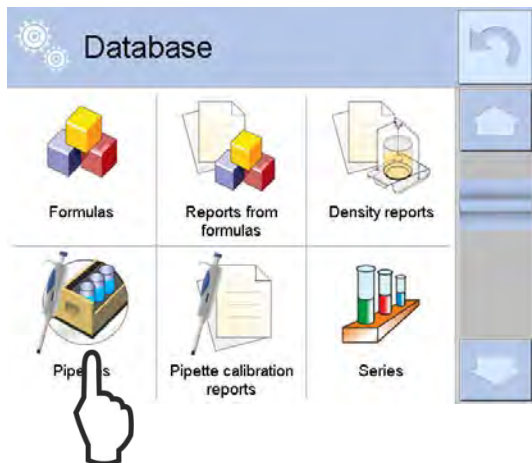

⇒ Tap <Pipettes>

Define new pipette:



⇒ To add a new data record, tap < >.

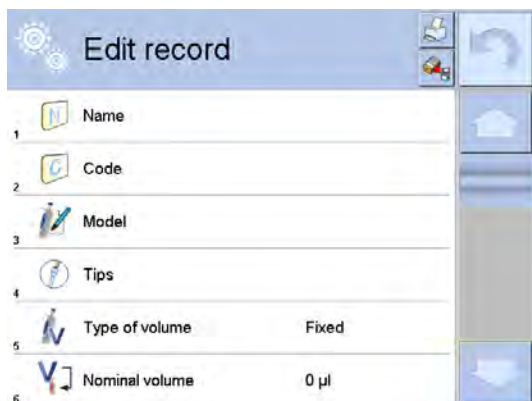

⇒ The selection list will appear. Individual settings can be called and changed as follows by tapping individual icons:



1. Name

- ⇒ In the selection list and tap **<Name>**.
- ⇒ The alphanumeric input window will appear.
- ⇒ Enter name of pipette and confirm with



2. Code

- ⇒ In the selection list and tap **<Code>**.
- ⇒ The alphanumeric input window will appear.
- ⇒ Enter code and confirm with

3



3. Model

- ⇒ Tap **<Model>** in the selection list.
- ⇒ The alphanumeric input window will appear.
- ⇒ Enter model and confirm with



4. Pipette points

- ⇒ Tap **< Pipette points >** in the selection list.
- ⇒ The alphanumeric input window will appear.
- ⇒ Enter name for the points and confirm by

5



5. Type of volume

- ⇒ Tap **< Type of volume >** in the selection list, options include constant or variable.

6



6. Nominal volume

- ⇒ Tap **< Nominal volume >** in the selection list.
- ⇒ The alphanumeric input window will appear.
- ⇒ Enter nominal volume for the pipette to be tested and confirm by

7



7. Minimum volume

- ⇒ Tap **< Minimum volume >** in the selection list.
- ⇒ The alphanumeric input window will appear.
- ⇒ For pipettes with variable volume enter the minimum volume and confirm by . For pipettes with fixed volume enter the value "0".

8

00285

8. Number of channels

- ⇒ Tap **< Number of channels >** in the selection list.
- ⇒ The alphanumeric input window will appear.
- ⇒ Enter the number of channels for the pipette to be tested and confirm by .
For pipettes with one channel enter the value "1".



9. ISO 8655 Type

⇒ Tap < **ISO 8655 type** > in the selection list, options include none, A, D1, D2. For the selected test volume the program automatically assumes the values of error limits as per ISO 8655 during the pipette test.

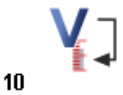

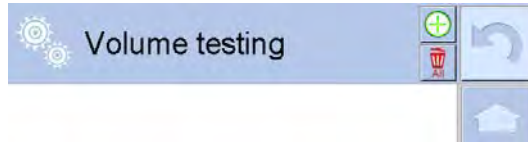

10. Test volume

⇒ Tap < **Test volume** > in the selection list.

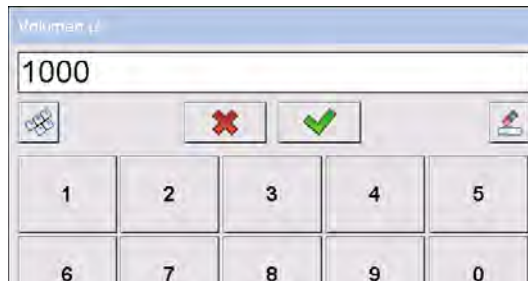

⇒ Tap <  >.



⇒ Enter test volume and confirm by .

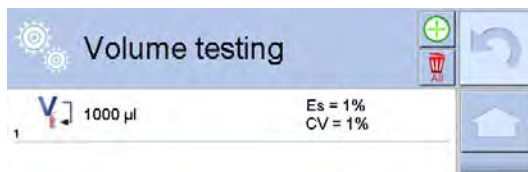

⇒ The test volume including the error limits for systematic errors of measurement [Es] and the random errors [CV] are indicated in %. To change error limits, tap the command button and enter the desired values.

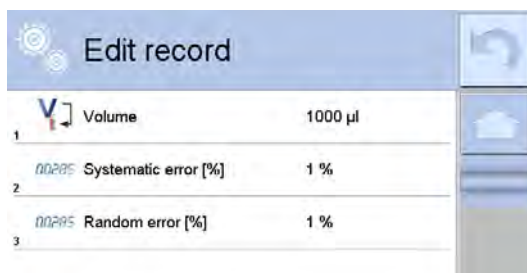

19.4 Performing a pipette test

Condition:

Pipette is already defined in database <Pipettes>; see chap. 19.3.

For Settings for display example see chap. 19.2.1:

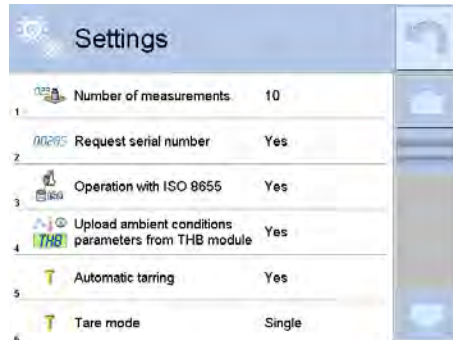

Procedure:

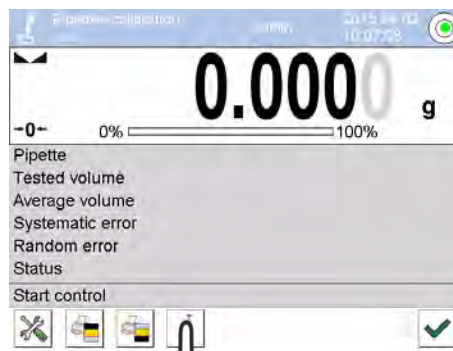

1. Press function key  and select type of pipette such as <RP-AF1000> from the list.

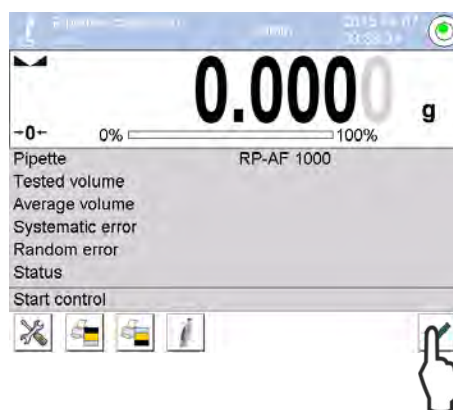





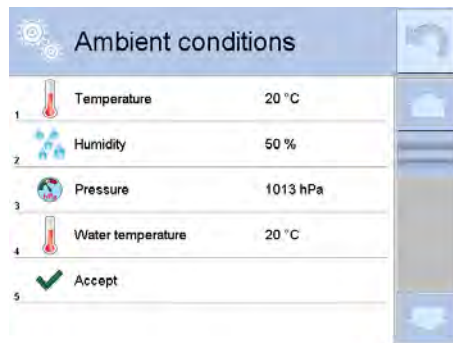

2. The selected type will be shown under <Pipette>. Start procedure with key .



- When the < 00285 > function is enabled (see chap. 19.2.1) a query will appear and ask you to enter the serial number. If required, enter serial number in editing window and confirm by .



- The settings for ambient data will be displayed.

When the <  > function is **enabled** (See chap. 19.2.1) the current ambient data ( temperature,  humidity,  air pressure) will be applied by the THB module and shown on the screen. Enter the value for the temperature of the test liquid with  and confirm by .

When the function is **disabled** all current data will have to be determined and entered externally.

5. Tap command button  Accept > and the display will return to the work screen.

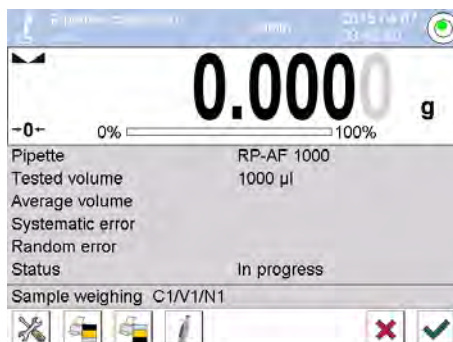

The info box provides the following information.

Pipette (selected type)	RP-AF1000	
Tested volume	1000 µl	
Status	Implemented	
Test weighing	C1 / V1 / N1	
	C1	Channel n.
	V ₁	Volume no. of channel
	N1	No of current test cycle

6. Place a weighing container filled with test liquid (such as water) on the scales, wait for stability sign, then tare.
7. Use pipette to draw up selected test volume for the first test cycle and meter it into the dish. Wait for stability display and confirm measured value by . When tare mode **<automatic>** is selected, the weighing scale will be tared automatically. When tare mode **<manual>** is selected the weighing scale must be tared with the help of the TARE key. Setting see chap. 19.2.1

Repeat this test cycle as often as defined under  number of measurements>; see chap. 19.2.1.

8. Once the last measured value has been confirmed, another query will ask you about ambient conditions; see step 4. This is necessary as data may have changed during the test.

Tap command button  Accept .

If an optional printer is connected, the measurement report will be printed. For printed example see chap. 19.5.

9. Finish test with . The balance is now ready for further measurements.

19.5 Logging a pipette test

Printed example default report (KERN YKB-01N):

-----Pipettes calibration-----		
Operator		Admin
Pipette		RP-AF1000
Serial no		GF202077
Number of channels		1
Number of measurements		10
Operation with ISO 8655		Yes
Start date	2015.03.05	11:12:30
End date	2015.03.05	11:17:30
Water Temperature		21°C
Temperature		21°C
Humidity		48 %
Pressure		1007hPa
Z coefficient		1.00283
-----Tested volume: 1000 µl -----		
1	0.998 g	1000.82389 µl
2	0.998 g	1000.82389 µl
3	0.998 g	1000.82389 µl
4	0.998 g	1000.82389 µl
5	0.998 g	1000.82389 µl
6	0.998 g	1000.82389 µl
7	0.998 g	1000.82389 µl
8	0.998 g	1000.82389 µl
9	0.998 g	1000.82389 µl
10	0.998 g	1000.82389 µl
Average volume		1000.82389 µl
Average [%]		100.08 %
Systematic error		0.82389 µl
Systematic error [%]		0.082389 %
Permissible error		± 16 µl
Random error		0 µ
Random error [%]		0 %
Permissible error		± 6 µl
Status		positive

Signature		

As soon as a measurement report is printed the data record will be saved automatically to the database under **<Reports of pipette calibration >**.

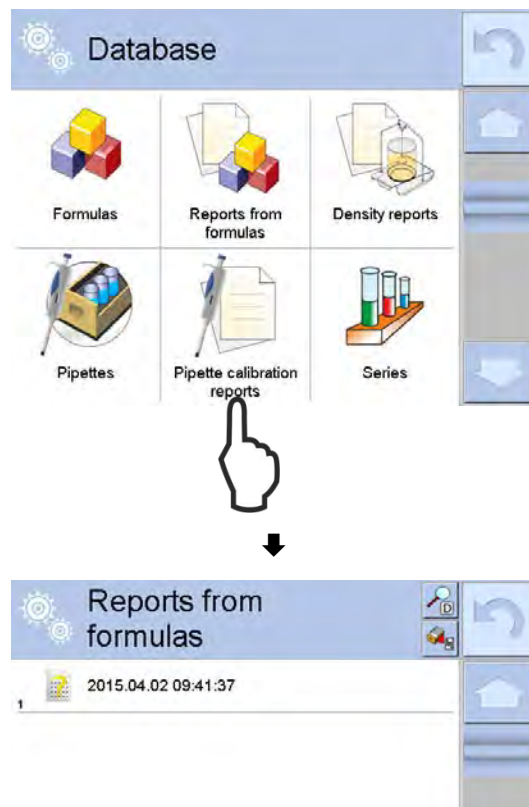

To **<Open/Print>** press and hold your finger on the desired data record until the context menu appears.

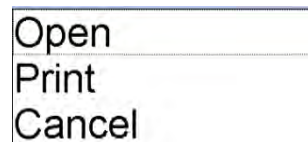



20 Database

Call database menu:

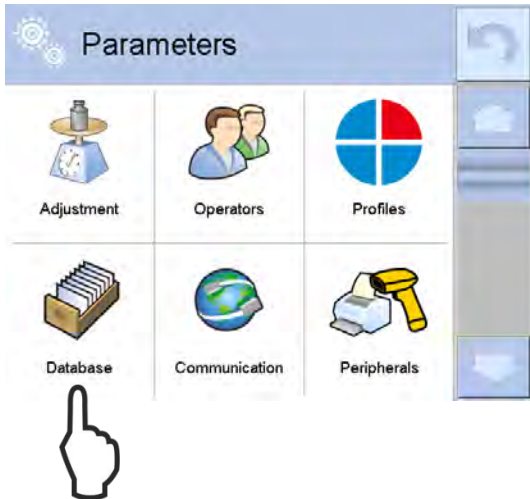

⇒ Press  or .

⇒ Tap **<Database>**.

The selection list of databases will be displayed



Products, see chap. 20.3



Weighing procedures, see chap. 20.3



Customers, see chap. 20.3



Formulas, see chap. 17.4



Report of formulas, see chap. 17.7.



Report of density, see chap. 15.4



Pipettes, see chap. 19.3



Report from pipette calibration, see chap. 19.5



Series not documented



SQC, not documented



Environment, not documented



Packaging, not documented



Memory, not documented



Printouts, not documented



Universal variables, not documented



Managing databases, see chap. 20.3

20.1 General database operations (authorised users only)

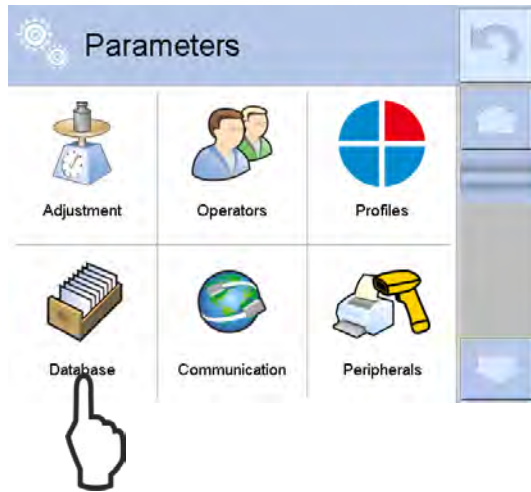

Tap <Database>.





The selection list will appear.

Press and hold the icon for the database to be edited.



The options available depend on the menu.

i If correspondingly assigned, databases can be called via the function keys such as  for < products >.

<Opening>	Opening existing databases
< Import >	Retrieve database file from USB storage medium: <ul style="list-style-type: none"> ⇒ Connect USB storage medium to USB port. ⇒ Select file to be retrieved. ⇒ Import will be started automatically. ⇒ When the process is finished confirm the message <Finished> by  .
< Export >	Export database file to USB storage medium: <ul style="list-style-type: none"> ⇒ Connect USB storage medium to USB port. ⇒ Export will be started automatically. ⇒ When the process is finished confirm the message <Finished> by  .
<Information>	Show content of database
<Cancel>	Back to last view

20.2 General database operations (Authorised users only)



Tap icon of database to be edited.

The options available depend on the menu.



The following options will become available by tapping the icon in the top right corner:



Add new data record



Search data record by date



Search data record by name



Search data record by code



Export data record to USB storage medium

20.3 Description for individual databases



1. Products

To create new data records, either use  to add new data record or select existing data record from menu, rename it, then edit.

The selection list will appear. To call and change individual settings, tap the individual icons.



2. Weighing data (Alibi memory)

Insofar as stipulated by national regulations, all weighing activities can be traced in the alibi memory. All weighing activities are saved to the alibi report file, containing the stipulated data.

ID	Date and Time	Weight (g)
23	2015.03.31 11:24:33	17.7274 g
24	2015.04.02 09:36:12	25.0003 g
25	2015.04.02 09:37:30	6.9995 g
26	2015.04.02 09:38:13	0.5127 g
27	2015.04.02 09:41:34	70.0002 g

Call alibi report files:

- ⇒ Tap **<Weighing data >**; see chap. 20.2
- ⇒ The alibi data records of the last five weighing activities will be displayed.
- ⇒ To display information about an executed weighing action tap the respective item

Fast search by date:

Tap .

- ⇒ Enter year, month, hour and minute one after the other and confirm by .

- ⇒ The report file menu will be displayed. The searched for file will be shown on top of the list.



3. Customers

To create new data records, either use  to add new data record or select existing data record, rename it, then edit.

1 Name
2 Code
3 TIN
4 Address
5 Postal code
6 City

The selection list will appear.
To call and change individual settings, tap the individual icons.



4. Managing database



⇒ Tap < **Manage the database** >; see chap. 20.2

The three options available will be displayed.



Exporting weighing data to USB storage medium



⇒ Connect USB storage medium to USB port.

⇒ Tap < **Export weighing database to a file** >.

⇒ In the selection list select the options for export.

The user can go to the options <**Data selection**> and define which data are to be exported for the measurements.

⇒ After selecting your options tap command button < **Export weighing database to a file** >.

Export will start automatically.

⇒ When the export is finished you will receive the following message:

„**Completed**” together with details about the data volume exported as well as the data name (with the extension *.txt).

Afterwards the weighing scale will return to the previous window.



Deleting databases

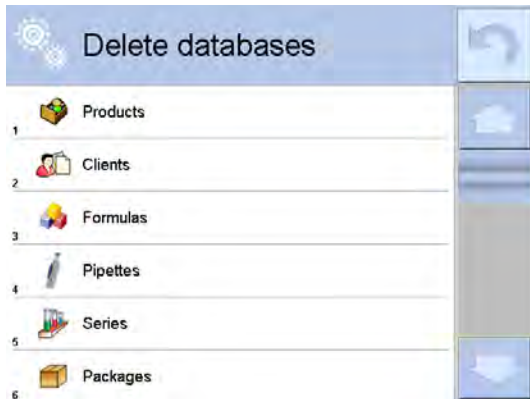

⇒ Tap < **Delete database** >.

⇒ In the selection list select the desired database.



⇒ Confirm deleting process with



Deleting weighing processes and reports



⇒ Tap <**Delete weighing processes and reports**>.

⇒ Enter a date before which data is to be deleted.
Enter year, month and day, one after the other, and confirm by .

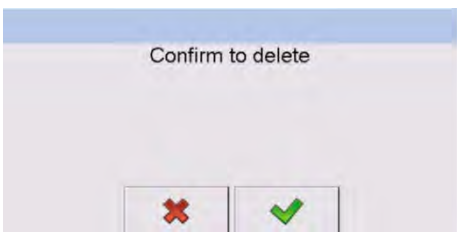

⇒ Confirm deleting process with
Details of deleted data records will be displayed.

⇒ Reconfirm with

21 Communication

21.1 Overview interface commands

Subsequent commands will be detected by the weighing scale.

Commands	Function
Z	Zeroing
T	Taring
UT	Retrieve tare value
LT	Set tare value
S	Send stable weighing value in standard weighing unit
SI	Send weighing value immediately in standard weighing unit
SIA	Send weighing values for all platforms in default unit immediately
SU	Send stable weighing value in current weighing value
SUI	Send weighing value immediately in current weighing unit
C1	Start continuous output in standard weighing unit
C0	Stop continuous output in standard weighing unit
CU1	Start continuous output in current weighing unit
CU0	Stop continuous output in current weighing unit
DH	Set value for lower threshold
UH	Set value for upper threshold
ODH	Retrieve value for lower threshold
OUH	Retrieve value for upper threshold
SS	Press simulation "PRINT key"
PC	Send all implemented commands
LOGIN	Log in user
LOGOUT	Log off user



Complete command with CR/LF characters.

21.2 General reply format

Commands	Function
XX_ <i>A CR LF</i>	Command accepted, executing command was started
XX_ <i>D CR LF</i>	Execution of previously started command was completed (Only occurs after XX_ <i>A</i>)
XX_ <i>I CR LF</i>	Valid command but at present cannot execute command
XX_ <i>^ CR LF</i>	Valid command but range limit was exceeded
XX_ <i>v CR LF</i>	Valid command but range limit not reached
XX_ <i>OK CR LF</i>	Command accepted and executed
ES_ <i> CR LF</i>	Invalid entry
XX_ <i>E CR LF</i>	Time limit for stabilisation of weighing scale display was exceeded.

i	XX	Command such as Z = zero
	_	Space character (20h, 0x20)

21.3 Detailed information to interface reports

21.3.1 Zeroing

Command: **Z** CR LF

Possible answers:

Z _␣ CR LF	Command accepted, executing command was started
Z _␣ D CR LF	Execution of previously started command was completed
Z _␣ A CR LF	Command accepted, executing command was started
Z _␣ ^ CR LF	Valid command but space character range was exceeded
Z _␣ A CR LF	Command accepted, executing command was started
Z _␣ E CR LF	Time limit for stabilisation of weighing scale display was exceeded
Z _␣ CR LF	Valid command but at present cannot execute command

21.3.2 Taring

Command: **T** CR LF

Possible answers:

T _␣ A CR LF	Command accepted, executing command was started
T _␣ D CR LF	Execution of previously started command was completed
T _␣ A CR LF	Command accepted, executing command was started
T _␣ ^ CR LF	Valid command but tare range was exceeded
T _␣ A CR LF	Command accepted, executing command was started
T _␣ E CR LF	Time limit for stabilisation of weighing scale display was exceeded
T _␣ I CR LF	Valid command but at present cannot be executed

21.3.3 Query tare value

Command: **OT CR LF**

Response:

1	2	3	4 - 12	13	14 - 16	17	18	19
O	T	▬	Tare	▬	Unit	▬	CR	LF

Tare value: - 9 characters with right alignment

Unit: - 3 characters with left alignment

i	The tare value is always issued using the adjustment unit
----------	---

21.3.4 Set tare value

Command: **UT_TARA CR LF**, (**TARA** = Tare value)

Possible responses:

UT_OK CR LF	Command executed
UT_I CR LF	Valid command but at present cannot be executed
ES CR LF	Invalid entry

i	Set tare value: <ul style="list-style-type: none"> • Mark decimal place with decimal point • Without weighing unit
----------	--

21.3.5 Send stable weighing value in standard weighing unit

Command: **S CR LF**

Possible responses:

S_A CR LF	Command accepted, executing command was started
S_E CR LF	Time limit for stabilisation of weighing scale display was exceeded
S_I CR LF	Valid command but at present cannot be executed

1	2-3	4	5	6	7-15	16	17-19	20	21
S	▬	Stability symbol*	▬	Signs	Weight	▬	Unit	CR	LF

Example:

S CR LF	Sent command: Send stable weighing value in standard weighing unit
S _ A CR LF	Command accepted, executing command was started
S _ _ _ _ _ _ _ _ _ _ 8 . 5 _ g _ _ CR LF	Command executed Weighing value will be issued in default weighing unit

i	Stability symbol*	
	?	instable (3Fh, 0x3F)
	_	stable (20h, 0x20)

21.3.6 Send weighing value immediately in standard weighing unit

Command: **SI CR LF**

Possible responses:

SI _ CR LF	Valid command but at present cannot be executed
-------------------	---

1	2	3	4	5	6	7-15	16	17-19	20	21
S	I	_	Stability symbol	_	Signs	Weight	_	Unit	CR	LF

Example:

SI CR LF	For sent command see chap. 21.1
S I _ ? _ _ _ _ _ _ _ _ 1 8 . 5 _ k g _ CR LF	Command executed Weighing value will be issued in default weighing unit

21.3.7 Send weighing values for all platforms immediately

Command: **SIA CR LF**

Possible response

SIA_ CR LF	Valid command but at present cannot be executed
-------------------	---

1	2	3	4	5	6	7-15	16	17-19	20	21
S	I	_	Stability symbol	_	Signs	Weight	_	Unit	CR	LF

- n** - Number of platform
- Weight** - 9 characters with right alignment
- Unit** - 3 characters with left alignment

Example (two connected platforms):

S I A CR LF	For sent command see chap. 21.1
P 1_?_1 1 8 . 5_g_ CR LF	Command executed, Weighing values for platforms will be issued in the default weighing unit
P 2_3 6 . 2_k g_ CR LF	

21.3.8 Send stable weighing value in current weighing value

Command: **SU CR LF**

Possible responses:

SU_ CR LF	Command accepted, executing command was started
SU_ CR LF	
SU_ CR LF	Valid command but at present cannot be executed
SU_ CR LF	Command accepted, executing command was started

1	2	3	4	5	6	7-15	16	17-19	20	21
S	U	_	Stability symbol	_	Signs	Weight	_	Unit	CR	LF

Example:

S U CR LF	For sent command see chap. 21.1
S U_ CR LF	Command accepted, executing command was started
S U_1 7 2 . 1 3 5_N_ CR LF	Command executed Weighing value will be issued in the current weighing unit.

21.3.9 Send weighing value immediately in current weighing unit

Command: **SUI CR LF**

Possible responses:

SUI CR LF	Valid command but at present cannot be executed
------------------	---

1	2	3	4	5	6	7-15	16	17-19	20	21
S	U	I	Stability symbol	▬	Signs	Weight	▬	Unit	CR	LF

Example:

SUI CR LF	For sent command see chap. 21.1
SUI ?_ -_ _ _ 5 8 . 2 3 7_ k g_ CR LF	Command executed Weighing value will be issued in the current weighing unit

21.3.10 Start continuous output in standard weighing unit

Command: **C1 CR LF**

Possible responses:

C1 CR LF	Valid command but at present cannot be executed
C1_A CR LF	Command accepted, executing command was started
	Weighing values will be issued in the default weighing unit

1	2	3	4	5	6	7-15	16	17-19	20	21
S	I	▬	Stability symbol	▬	Signs	Weight	▬	Unit	CR	LF

21.3.11 Stop continuous output in standard weighing unit

Command: **C0 CR LF**

Possible responses:

C0 CR LF	Valid command but at present cannot be executed
C0_A CR LF	Command accepted, executing command was started

21.3.12 Start continuous output in current weighing unit

Command: **CU1 CR LF**

Possible responses:

CU1_I CR LF	Valid command but at present cannot be executed
CU1_A CR LF	Command accepted, executing command was started
	Weighing values will be issued in the current weighing unit

1	2	3	4	5	6	7-15	16	17-19	20	21
S	U	I	Stability symbol	▬	Signs	Weight	▬	Unit	CR	LF

21.3.13 Stop continuous output in current weighing unit

Command: **CU0 CR LF**

Possible responses:

CU0_I CR LF	Valid command but at present cannot be executed
CU0_A CR LF	Command accepted, executing command was started

21.3.14 Set value for “lower threshold“

Message: **DH_XXXXX CR LF** (XXXXX = threshold)

Possible responses:

DH_OK CR LF	Command executed
ES CR LF	Command not accepted

21.3.15 Set value for “upper threshold“

Command: **UH_XXXXX CR LF** (XXXXX = threshold value)

Possible responses:

UH_OK CR LF	Command executed
ES CR LF	Command not accepted

21.3.16 Retrieve value for “lower threshold“

Command: **ODH CR LF**

Possible responses:

DH_MASA CR LF	Command executed
----------------------	------------------

1	2	3	4-12	13	14-16	17	18	19
D	H	▬	Weight	▬	Unit	▬	CR	LF

Weight - 9 characters with right alignment
Unit - 3 characters with left alignment

21.3.17 Retrieve value for “upper threshold“

Command: **OUH CR LF**

Possible answers:

UH_MASA CR LF	Command executed
----------------------	------------------

1	2	3	4-12	13	14-16	17	18	19
D	H	▬	Weight	▬	Unit	▬	CR	LF

Weight - 9 characters with right alignment
Unit - 3 characters with left alignment

21.3.18 Press simulation “PRINT key“

Command: **SS CR LF**

The command **S S CR LF** is used to save the weighing process directly to the database, followed by a printout where an optional printer is connected.

21.3.19 Send all implemented messages

Command: **PC CR LF**

Response:

PC A

"Z,T,S,SI,SU,SUI,C1,C0,CU1,CU0,DH,ODH,UH,OUH,OT,UT,SIA,SS, PC"

21.4 Data format

1	2	3	4-12	13	14-16	17	18
stability	□	Signs	Measuring Value	□	Unit	CR	LF

Stability symbol	[□] stable
	[?] instable
	[^] overload
	[v] underload
Signs	[□] positive values
	[-] negative values
Measuring Value	9 characters with right alignment
Unit	3 characters with left alignment

Example (stable / positive weighing value):

□□□□□□ 1 8 3 2 . 0 □ g □ □ CR LF

22 Servicing, maintenance, disposal



Before any maintenance, cleaning and repair work disconnect the appliance from the operating voltage.

22.1 Cleaning

Do not use aggressive detergents (solvents or similar). Ensure that no liquid penetrates into the device. Polish with a dry soft cloth. Loose residue sample/powder can be removed carefully with a brush or manual vacuum cleaner.

Spilled weighing goods must be removed immediately.

22.2 Servicing, maintenance

- ⇒ The appliance may only be opened by trained service technicians who are authorized by KERN.
- ⇒ Ensure that the balance is regularly calibrated, see chap. Monitoring of test resources.

22.3 Disposal

- ⇒ Disposal of packaging and appliance must be carried out by operator according to valid national or regional law of the location where the appliance is used.

23 Troubleshooting guide / error messages

Possible causes of errors:

In case of an error in the program process, briefly turn off the balance and disconnect from power supply. The weighing process must then be restarted from the beginning.

Fault

Possible cause

The displayed weight does not glow.

- The display unit is not switched on.
- Mains power supply interrupted (mains cable defective).
- Power supply interrupted.

The displayed weight is permanently changing

- Draught/air movement
- Table/floor vibrations
- Weighing pan has contact with other objects.
- Electromagnetic fields / static charging (choose different location/switch off interfering device if possible)

The weighing result is obviously incorrect

- The display of the balance is not at zero
- Adjustment is no longer correct.
- Great fluctuations in temperature.
- Warm-up time was ignored.
- Electromagnetic fields / static charging (choose different location/switch off interfering device if possible)

No data transfer between printer and balance.

- Communication settings are wrong.

The menu setting cannot be changed.

- Menu item is locked for models with type approval certificate.

Error messages:

Err2	Value beyond zero range
Err3	Value beyond tare range
Err8	Time limit exceeded for process, tare or reset to zero
NULL	Error AD transformer
FULL	Weighing range exceeded
no level	Weighing scale not levelled
Err 100	Restart required

24 Appendix A – variables for printouts

24.1 Variables menu

Symbol	Description
{0} ¹⁾	Default printout in adjustment unit
{1} ¹⁾	Default printout in current unit
{2}	Date
{3}	Time
{5}	Mathematical formula
{4}	Date and time
{6}	Net weight in current unit
{7}	Net weight in adjustment unit
{8}	Gross weight
{9}	Tare
{10}	Current unit
{11}	Adjustment unit
{12}	Min. threshold
{13}	Max. threshold
{14}	Serial number
{15}	Statistics: Number
{16}	Statistics: Sum
{17}	Statistics: Mean Value
{18}	Statistics: Min
{19}	Statistics: Max
{20}	Statistics ZZ: Qty.
{21}	Statistics ZZ: Sum
{22}	Statistics ZZ: Mean Value
{23}	Statistics ZZ: Min
{24}	Statistics ZZ: Max
{25}	Weight: [lb]
{26}	Checking results
{27}	Value
{28}	Value Z
{29}	Value ZZ
{30}	Gross value

{31}	Number of platform
{32}	Manufacturer ID number
{33}	Interval of weighing scale
{34}	Range
{35}	Parts counting: Mass of reference weight
{36}	Divergences: Mass of reference weight
{37}	Statistics: Standard Deviation
{38}	Statistics ZZ: Standard Deviation
{39}	Universal variable
{40}	Text information
{41}	Lot number
{42}	Statistics: Counter for weighing processes
{43}	Weight of platform
{44}	Weighing scale type
{45}	Parts counting: Reference quantity
{46}	Statistics ZZ: Total of measurements
{47}	Statistics: Gross total
{48}	Statistics ZZ: Gross total
{50}	Product: Name
{51}	Product: Code
{52}	Product: EAN code
{53}	Product: Weight
{54}	Product: Tare
{55}	Product: Cost
{56}	Product: Min
{57}	Product: Max
{58}	Product: FPVO mode
{59}	Product: Number of expiration dates
{60}	Product: VAT
{61}	Product: Date
{62}	Product: Expiration date
{63}	Product: Density
{64}	Product: ingredients
{65}	Product: Description
{66}	Product: Lower deviation
{67}	Product: Upper deviation
{68}	Product: Categorie
{75}	User: Name
{76}	User: Code

{77}	User: Authorisations
{80}	Packaging: Name
{81}	Packaging: Code
{82}	Packaging: Weight
{85}	Customer: Name
{86}	Customer: Code
{87}	Customer: Tax ID number
{88}	Customer: address
{89}	Customer: Postcode
{90}	Customer: Place
{91}	Customer: Discount
{100}	Weighing report: Measurements
{101}	Filter weighing report: Start date
{102}	Filter weighing report: Completion date
{103}	Filter weighing report: Product
{104}	Filter weighing report: User
{105}	Filter weighing report: Customer
{106}	Filter weighing report: Packaging
{106}	Filter weighing report: Product
{107}	Filter weighing report: Min
{108}	Filter weighing report: Max
{110}	Filter weighing report: Party no
{111}	Filter weighing report: Target memory
{112}	Filter weighing report: Source memory
{113}	Filter weighing report: Checking results
{114}	Filter weighing report: Platform no
{115}	Filter weighing report: Number of weighing procedures
{116}	Filter weighing report: Total of weighing processes
{117}	Filter weighing report: Value
{118}	Filter weighing report: Gross value
{119}	Filter weighing report: Mean Value
{120}	Filter weighing report: Min
{121}	Filter weighing report: Max
{122}	Filter weighing report: Vehicle
{130}	Source memory: Name
{131}	Source memory: Code
{132}	Source memory: Description
{135}	Target memory: Name
{136}	Target memory: Code

{137}	Target memory: Description
{140}	Net weight of adjustment unit: Sum
{141}	Additional display: WD
{142}	Additional display: WWG
{143}	Hex
{144}	Hex UTF-8
{145}	Part weight
{146}	Gross weight in current unit
{147}	Tare in current unit
{148}	Additional display: PUE7
{149}	IP-address
{155}	Density: Start date
{156}	Density: Completion date
{157}	Density: Method
{158}	Density: Reference liquid
{159}	Density: Density of reference liquid
{160}	Density: Temperature
{161}	Density: Volume of plummet
{162}	Density
{163}	Density: Unit
{164}	Density: Sample number
{165}	Density: Weighing process 1
{166}	Density: Weighing process 2
{167}	Density: Weighing process 3
{168}	Density: Volume
{169}	Density: Mass of pycnometer
{170}	Density: Volume of pycnometer
{175}	Dosing process: Name
{176}	Dosing process: Code
{177}	Dosing process: Cycle number
{178}	Dosing process: Number of cycles
{180}	Dosing report: Start date
{181}	Dosing report: Completion date
{182}	Dosing report: Result
{183}	Dosing report: Number of measurements
{184}	Dosing report: Sum
{185}	Dosing report: Measuring
{186}	Measurements: Nominal weight

{187}	Measurements: Difference
{190} ³⁾	Comparator: Report number
{191} ³⁾	Comparator: Start date
{192} ³⁾	Comparator: Completion date
{193} ³⁾	Comparator: Job number
{194} ³⁾	Comparator: Number of test weight
{195} ³⁾	Comparator: Number of reference weight
{196} ³⁾	Comparator: Measuring
{197} ³⁾	Comparator: Average difference
{198} ³⁾	Comparator: Standard Deviation
{199} ³⁾	Comparator: Number of cycles
{200} ³⁾	Comparator: Method
{205}	Adjustment history: Nominal weight
{206}	Adjustment history: Number of platform
{209}	Vehicle: User
{210}	Vehicle: Name
{211}	Vehicle: Code
{212}	Vehicle: Description
{213}	Vehicle: Start date
{214}	Vehicle: Completion date
{215}	Vehicle: Weight of entry ramp
{216}	Vehicle: Weight of exit ramp
{217}	Vehicle: Weight of load
{218}	Vehicle: Type of transaction
{219}	Vehicle: Status
{220}	Formula: Name
{221}	Formula: Code
{222}	Formula: Cycle number
{223}	Formula: Number of cycles
{224}	Formula: Process status
{225}	Formula: Process status in %
{226}	Formula: Name of component
{227}	Formula: Difference
{228}	Formula: Dose
{229}	Formula: Nominal weight
{230}	Formula: Number of current ingredient
{231}	Formula: Number of ingredients
{232}	Formula: Number of current batch
{233}	Formula: Number of batches

{234}	Formula: Status
{235}	Formula: Min
{236}	Formula: Max
{237}	Formula: Code of ingredient
{240}	Formula report: Start date
{241}	Formula report: Completion date
{242}	Formula report: Result
{243}	Formula report: Number of measurements
{244}	Formula: Total weight
{245}	Formula report: Measuring
{246}	Measurements: Nominal weight
{247}	Measurements: Difference
{248}	Formula report: Code of ingredient
{295}	Report average tare: Date
{296}	Report average tare: Result
{297}	Report average tare: Standard Deviation
{298}	Report average tare: 0,25T1
{299}	Report average tare: Number of measurements
{300}	Report average tare: Measuring
{301}	Report average tare: Report no
{302}	Report average tare: Average tare
{303}	Report average tare: Note

24.2 Format variables

The user can format at will number variables, text variables and dates that are used for printout or as information in the work area of the displays.

Formatting options:

- Left alignment
- Right alignment
- Number of characters for printout / display
- Number of decimal places for number variables
- Date / time format
- Convert number variables based on code EAN13,
- Convert number variables and date based on code EAN128.

Definition of formatting:

All formatting elements show the following form and comprise the following components:

{Variable number}

{Variable number, field width}

{Variable number: format character string}

{Variable number, field width: format character string}

The matching curly brackets ("{" and "}") are essential.

Variable number, see chap. 24.1 "Variables menu"

Alignment component

The *alignment* component consist of an integral number including sign, specifying the desired formatted field width. If the value for *alignment* is less than the length of the formatted character string, *alignment* will be ignored and the length of the formatted character string applied as field length. The formatted data in the field will be aligned in the field for a positive value with right *alignment* and for a negative value with left *alignment*. If fill characters are required, use spaces. Commas are required for indicating *alignment*.

Formatting character string components

The optional component *formatting character string* describes the way stated characters are issued. Details may include the following:

Enter a default or user defined numerical formatting character string when the object is a sign. Specify details for a default or user defined formatting style sheet for date and time. Specify a corresponding string. If there is no *formatting character string*, apply the general format identifier ("G"). A colon will be required when you specify the *formatting character string*.

Special signs for formatting:

Character	Description	Example
,	Separator for variables with left alignment	{7,10} – Net weight with unit Field width 10 signs Left alignment
-	Separator for variables with right alignment	{7,-10} – Net weight with unit, max. 10 signs with right alignment
:	Separators for time (hours, minutes, seconds) with corresponding formatting	{7:0.000} – Net weight with unit and three decimal places; {3:hh:mm:ss} – Current time in format: Hour: Minute: Second
.	The first point after a number is regarded a separator from the decimal place. Any additional points will be ignored.	{55:0.00} – The unit price of a product always requires two decimal places; {17:0.0000} – The mean value of measurements always requires four decimal places.
F	Fixed comma Integral numbers and decimal numbers with optional minus sign.	{7:F2} – Net weight with unit always with two decimal places {7,9:F2} – Net weight with unit always with two decimal places providing a field width of 9 signs with right alignment
V	Formatting a weight value in barcode EAN13	{7:V6.3} – Net weight as barcode EAN13 (Code comprising 6 signs) with three decimal places
T	Formatting a weight value as barcode EAN128	{7:T6.3} – Net weight as barcode EAN128 with three decimal places
/	Separator for date between days, months and years	{2:yy/MM/dd} - Current date in format: Year - month - day; yy here stand for the two last numbers of the year
\	The “escape” sign removes the formatting function of the next sign. This sign is considered as text.	{2:yy\MM\dd} – Current date in format: Year / month / day; {2:yy\:MM\:dd} – Current date in format: Year: Month: Day

Examples:

CODE	Description
{7:V6.3}	Net weight as EAN 13 (Code comprising 6 signs)
{7:V7.3}	Net weight as EAN 13 (Code comprising 7 signs)
{27:V6.3}	Net value as EAN 13 (Code comprising 6 signs)
{27:V7.3}	Net value as EAN 13 (Code comprising 7 signs)
{7:T6.3}	Net weight in EAN code 13
{16:T6.3}	Net weight K in EAN code 128
{21:T6.3}	Net weight KK in EAN code 128
{25:T6.3}	Net weight (lb) in EAN code 128
{8:T6.3}	Gross weight K in EAN code 128
{55:T6.2}	Product price in EAN code 128
{2:yyMMdd}	Date EAN code 128
{61:yyMMdd}	Product date EAN code 128
{62:yyMMdd}	Date of expiry for product in EAN code 128
{16:V6.3}	Net weight K in EAN code 13 (Code comprising 6 signs)
{16:V7.3}	Net weight K in EAN code 13 (Code comprising 7 signs)
{28:V6.3}	Net value K in EAN code 13 (Code comprising 6 signs)
{16:V7.3}	Net value K in EAN code 13 (Code comprising 7 signs)
{21:V6.3}	Net weight KK in EAN code 13 (Code comprising 6 signs)
{21:V7.3}	Net weight KK in EAN code 13 (Code comprising 7 signs)
{29:V6.3}	Net value KK in EAN code 13 (Code comprising 6 signs)
{29:V7.3}	Net value KK in EAN code 13 (Code comprising 7 signs)

24.3 Mathematical formula

The function containing mathematical formulas with the variable **<{5} Mathematical formula>** facilitates calculations of any kind. The following basic mathematical operations are possible:

- Adding (+)
- Subtracting (-)
- Multiplying (*)
- Dividing (/)

You can also use existing variables for your calculation. This allows you to load the weight from the platform and to process it correctly.

Example:

{5: ([43:1] + [43:2]) / 2}

When applying the variable **<{43} Weight of platform>** above the weight will be loaded from the platform (:1 und :2). Then it will be divided by 2.

The brackets enable you to make your calculation in the correct order according to mathematical basic principles.

Note:

The variables of mathematical calculation operations are saved between square brackets []; i.e. no longer as up to now, between curly brackets { }.

The user can apply advance functions that can modify data in an advanced way. Advanced functions are set as text characters and descriptions in brackets:

- round (sign, precision of rounding off (number) – rounding off
- abs (Numeric value) – Absolute value
- sin (Numeric value) - Sinus
- cos (Numeric value) - Cosine
- tan (Numeric value) - Tangent
- sqrt (Numeric value) - Root
- pow (Numeric value, basis of power (number) - power
- log (Numeric value) - Logarithm
- log10 (Numeric value) – Logarithm with base 10

There are additional functions available for modifying text values. These function allow you to edit text even during issuing:

- remove ("Text", starting place (number), number of signs for deleting (number) – The text will be issued after this entry. The sentence or the text of the defined starting place for the set number of signs will be removed.

Example: {5:remove ("example text",8,4)} = example

- substring ("text value", starting place (number), number of signs to be copied (number) – This function allows you to remove specific words from a text, with the rest remaining unchanged.

Example: {5:substring ("example text",1,8)} = example

- tolower ("text value") – Converts complete text to lower case letters.

Example: {5:tolower ("EXAMPLE")} = example

- toupper ("text value") – Converts complete text to upper case letters.

Example: {5:toupper ("example")} = EXAMPLE

- replace ("text value", old text, new text) – Reconverts the text containing changed letters or parts of the text from the second or third parameter.

Example: {5:replace ("2.000", "0", "1")} = 2.111

Note:



































The text values must be set between inverted commas " ".





















IMPORTANT: Always write text details between inverted commas. When applying existing variables from the database, please apply square brackets [].

For that purpose see example applying variable 50 (product name) below:

Toupper ([50]) = APPLE

25 Appendix B – “Function keys“ menu

Symbol	Description	Symbol	Description
	Profile		Confirm / start measurement
	Adjustment		Cancel
	Zeroing		User
	Taring		Call up system settings
	Pre-tare		Products
	Disable tare		Store
	Enable tare		Customer:
	Packaging		Help
	Printing		Enter reference single weight as numerical value
	Print header		Determine reference single weight by weighing
	Print footer		Reference piece number 5
	Units		Reference piece number 10
	Universal variable 1		Reference piece number 20
	Universal variable 2		Reference piece number 50
	Universal variable 3		Percent determination mode: Enter reference weight (100%) in numbers
	Universal variable 4		Percent determination mode: Determine reference weight (100%) by weighing
	Universal variable 5		Pipette calibration

	Determine limits for tolerance control		Differential weighing: Series
	Statistics		Differential weighing: Sample
	Add to statistics		Differential weighing: Taring
	Determine target value		D Differential weighing: Weighing process A
	Density determination of solids		Differential weighing: Weighing process B
	Determining density of liquids		Differential weighing: Weighing process T + A
	Air density		Differential weighing: Delete values
	Animal weighing		Differential weighing: Copy tare
	Formulation		Differential weighing: Add sample
	Multiplication factor formula		
	Weigh formula according to target value		
	Free Formulation		

26 Declaration of conformity



KERN & Sohn GmbH

D-72322 Balingen-Frommern

Postbox 4052

E-Mail: info@kern-sohn.de

Phone: 0049-[0]7433-9933-0

Fax: 0049-[0]7433-9933-149

Internet: www.kern-sohn.de

Declaration of conformity

EC Declaration of Conformity
EC- Déclaration de conformité
EC-Dichiarazione di conformità
EC- Declaração de conformidade
EC-Deklaracja zgodności

EC-Declaration of -Conformity
EC-Declaración de Conformidad
EC-Conformiteitverklaring
EC- Prohlášení o shode
ЕС-Заявление о соответствии

D	Konformitäts- erklärung	Wir erklären hiermit, dass das Produkt, auf das sich diese Erklärung bezieht, mit den nachstehenden Normen übereinstimmt.
EN	Declaration of conformity	We hereby declare that the product to which this declaration refers conforms to the following standards.
CZ	Prohlášení o shode	Tímto prohlašujeme, že výrobek, kterého se toto prohlášení týká, je v souladu s níže uvedenými normami.
E	Declaración de conformidad	Manifestamos en la presente que el producto al que se refiere esta declaración está de acuerdo con las normas siguientes
F	Déclaration de conformité	Nous déclarons avec cela responsabilité que le produit, auquel se rapporte la présente déclaration, est conforme aux normes citées ci-après.
I	Dichiarazione di conformità	Dichiariamo con ciò che il prodotto al quale la presente dichiarazione si riferisce è conforme alle norme di seguito citate.
NL	Conformiteit- verklaring	Wij verklaren hiermede dat het product, waarop deze verklaring betrekking heeft, met de hierna vermelde normen overeenstemt.
P	Declaração de conformidade	Declaramos por meio da presente que o produto no qual se refere esta declaração, corresponde às normas seguintes.
PL	Deklaracja zgodności	Niniejszym oświadczamy, że produkt, którego niniejsze oświadczenie dotyczy, jest zgodny z poniższymi normami.
RUS	Заявление о соответствии	Мы заявляем, что продукт, к которому относится данная декларация, соответствует перечисленным ниже нормам.

Electronic Balance: KERN AET, ILT_NM, PET

EU Directive	Standards
2004/108/EC	EN 61326-1:2006
2006/95/EC	EN 61010-1:2010

Date 22.01.2015
Date

Ort der Ausstellung 72336 Balingen
Place of issue

Signatur
Signature

Albert Sauter
KERN & Sohn GmbH
Manager
Managing director

KERN & Sohn GmbH, Ziegelei 1, D-72336 Balingen, Tel. +49-[0]7433/9933-0
Fax +49-[0]7433/9933-149, E-Mail: info@kern-sohn.com, Internet: www.kern-sohn.com