



Table of Contents

1. Safety and Liability	4	6. Wizards.....	31
1.1 General Information.....	4	6.1 Measurement Wizard	32
1.2 Liability.....	4	6.2 Device Verification	32
1.3 Safety Instructions.....	4	6.3 Impact Direction Calibration (Leeb only)	32
1.4 Correct Usage.....	4	6.4 Conversion Curve Creation.....	32
1.5 Optimizing Performance of the Battery System.....	4	6.5 Combined Method.....	34
2. Getting Started	5	6.6 Mapping Wizard (Coming Soon)	34
2.1 Installation	5	7. Information.....	35
2.2 Main Menu.....	6	7.1 Documents.....	35
3. Measurement	7	7.2 Upload PDF-Files from an USB-stick	35
3.1 Performing Measurements	7	8. System.....	36
3.2 Measurements Screen	10	8.1 Features.....	36
3.3 Measuring Methods	12	8.2 Probes.....	37
3.4 Instrument Verification / Daily Performance Check	24	8.3 Hardware	37
4. Settings	25	8.4 Date & Time.....	37
4.1 Measurements	25	8.5 Language.....	37
4.2 Verification (Performance & Uncertainty Check)	27	8.6 Device information.....	37
4.3 Conversions (Hardness Conversions)	28	9. Maintenance and Support	38
4.4 Reporting.....	28	9.1 Maintenance.....	38
5. Data (Explorer)	29	9.2 Support Concept	39
5.1 Measurements	29	9.3 Standard Warranty and Extended Warranty	39
5.2 Verifications.....	31	9.4 Disposal.....	39

10. Troubleshooting	40	14. Ordering Information	48
10.1 Incorrect Measurements / Failed Performance Check	40	14.1 Units	48
10.2 No Reading Displayed	41	14.2 Impact Devices & Probes	48
10.3 Battery	42	14.3 Parts and Accessories	49
10.4 Touchscreen Calibration	42	14.4 Test Blocks	
11. Equotip Link Software	42		
11.1 Starting Equotip Link.....	42		
11.2 Application Settings	42		
11.3 Connecting to an Equotip 550 Touchscreen Unit.....	43		
11.4 Connection to Portable Rockwell Probe	43		
11.5 Adjusting the Settings	43		
11.6 Exporting Data	44		
11.7 Exporting and Importing of Setting Profiles.....	45		
11.8 Exporting and Importing of Conversion Curves	45		
12. Technical Specifications	45		
12.1 Instrument	45		
12.2 Power Supply	46		
12.3 Equotip Leeb Impact Devices	46		
12.4 Equotip Portable Rockwell Probe.....	47		
12.5 Equotip UCI Probe.....	47		
13. Standards & Guidelines	47		

1. Safety and Liability

1.1 General Information

This manual contains important information on the safety, use and maintenance of the Equotip 550. Read through the manual carefully before the first use of the instrument.

1.2 Liability

Our “General Terms and Conditions of Sales and Delivery” apply in all cases. Warranty and liability claims arising from personal injury and damage to property cannot be upheld if they are due to one or more of the following causes:

- Failure to use the instrument in accordance with its designated use as described in this manual.
- Incorrect performance check for operation and maintenance of the instrument and its components.
- Failure to adhere to the sections of the manual dealing with the performance check, operation and maintenance of the instrument and its components.
- Unauthorised modifications to the instrument and its components.
- Serious damage resulting from the effects of foreign bodies, accidents, vandalism and force majeure.

All information contained in this documentation is presented in good faith and believed to be correct. Proceq SA makes no warranties and excludes all liability as to the completeness and/or accuracy of the information.

1.3 Safety Instructions

The equipment is not allowed to be operated by children or anyone under the influence of alcohol, drugs or pharmaceutical preparations. Anyone who is not familiar with this manual must be supervised when using the equipment.

- Carry out the stipulated maintenance properly and at the correct time.
- Following completion of the maintenance tasks, perform a functional check.

1.4 Correct Usage

The instrument is only to be used for its designated purpose as described herein.

- Replace faulty components only with original replacement parts from Proceq.
- Accessories should only be installed or connected to the instrument if they are expressly authorized by Proceq. If other accessories are installed or connected to the instrument then Proceq will accept no liability and the product guarantee is forfeited.

1.5 Optimizing Performance of the Battery System

To increase the performance of the battery, it is recommended to first completely discharge and then completely charge it.

2. Getting Started

The Equotip 550 is typically used for testing the hardness of metallic surfaces. The user has a choice to select either Leeb rebound, the Portable Rockwell or UCI principle, see chapter “3.1 Performing Measurements”.

In combination with the Equotip Leeb Impact Device U the instrument is used to test the roll hardness of paper, film or foil rolls.

2.1 Installation

To install the Battery into the Equotip 550 Touchscreen Unit, lift the stand as shown, insert the battery and fasten it in place with the screw.



Figure 1: Insert Battery

There are three status LEDs on the right side of the display. The middle light is the power indicator which is red when charging and turns to green when battery is fully charged. The lower LED is used for application specific notification.



NOTE! Only use the battery charger provided for charging.

- A complete charge requires < 9 h (Instrument not operating)
- Charging time is much longer if the instrument is in use.
- An optional Quick Charger (Part No. 327 01 053) can be used to charge a spare battery or to charge the battery outside of the instrument. In this case it takes < 5.5 h for a complete charge.

Buttons

On the upper right of the unit there are three buttons:



Power On/Off – Press to power on or to return to the home screen. Press and hold to power off.



Soft Key – Switches in and out of full screen view or toggles between the actual screen and the last viewed pdf document (eg. Operating Instructions).



Back Button – Returns to previous screen.

Energy Saving

Energy saving may be programmed as desired under System/Power settings, see chapter “8.3 Hardware”.

Connections



1 2
Snap-in connectors



USB Host
USB Device
Ethernet
Power Supply

Figure 2: Connections

For Leeb Impact Devices

use the Snap-in connector 1.

For UCI Probe

use the Snap-in connectors 1 or 2.

For the Portable Rockwell Probe

use the USB Host connector.

USB Host:

Additionally connect a mouse, keyboard or USB stick.

USB Device:

Connect to PC.

Ethernet:

Connection to network.

Power Supply:

Connect the power supply through this connection.

2.2 Main Menu

On start up the main menu is displayed. All functions may be accessed directly via the Touchscreen. Return to the previous menu by pressing the back button or the return icon (arrow) at the top left corner of the Touchscreen.

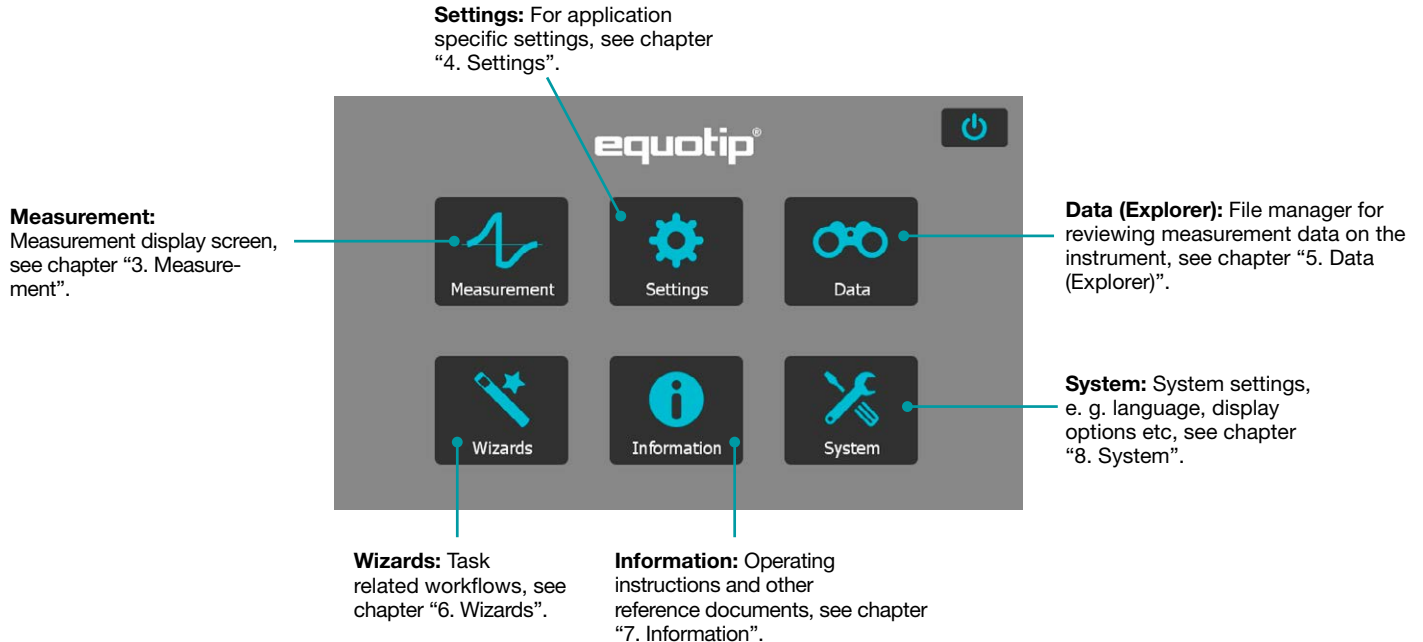

Figure 3: Main Menu

3. Measurement

3.1 Performing Measurements

3.1.1 Leeb Testing Procedure (except Leeb U)

Select automatic compensation for impact direction “Automatic”, see chapter “3.2.1 Controls”. If “Automatic” is not allowed, set the impact direction ($\downarrow \rightarrow \nearrow \uparrow$). The Equotip Leeb Impact Devices DL doesn't support automatic mode. The impact direction must be selected manually. Select the appropriate material group, hardness scales and number of impacts per measurement series. For more information see chapter “4. Settings”. Conduct impacts by cycling through “load, position and trigger” mechanism:

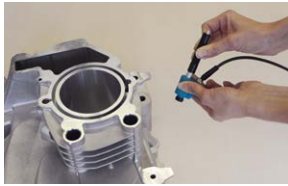

1. **Load** the impact device – while not in contact with the test piece – by holding it firmly with one hand and sliding the loading tube with the other hand until contact is grabbed by the clutch.



2. **Position** the support ring on the test piece. Take particular care to fully position the support ring on the test piece, but not coinciding with a previous test indentation.
3. To **trigger** an impact, press the trigger button to release the impact body. To perform another impact, repeat this cycle.

Figure 4: Leeb Testing Procedure

After the last of the impacts is performed, the hardness average and further statistics of the measurement series are displayed.



NOTE! Make sure the loading tube is allowed to slowly return back to the starting position. Do take care so the loading tube does not spring back uncontrolled, which may result in permanent device damage.



NOTE! If possible, follow the standard practice of Leeb rebound hardness testing as described in the standards DIN 50156-1 (metallic materials), ASTM A956 (steel, cast steel and cast iron only), or other applicable standards. If these are not available, the user is recommended to average a minimum of $n = 3$ impacts at an indentation distance of 3 to 5 mm (0.12 to 0.20”) for each location of the sample that shall be tested.



NOTE! Do not carry out an impact in an area that has already been deformed by another impact. Also, do not load the device when it is already positioned in the new test location, since the material under the device may be affected through prior stress, and the catch chuck of the device may get damaged.

3.1.2 Portable Rockwell Testing Procedure



1. **Place** the probe on the sample to test. For flat surfaces the standard foot is most suitable. For cylindrical objects it is recommended to use one of the special feet. For locations difficult to access a tripod foot can be used. See chapter “14. Ordering Information” for more details.



2. **Press** the probe slowly but firmly against the surface to perform the measurement. Suppress vibrations as much as possible, and follow the instructions on the screen.
3. **Release** the probe when the instrument says so. Again, this movement has to be done in a controlled manner. If the probe is released too fast, a warning will be shown and the measurement should be repeated.

Figure 5: Portable Rockwell Testing Procedure

3.1.3 UCI Testing Procedure

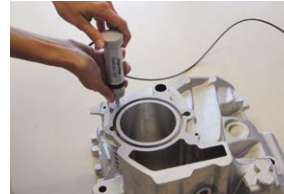

1. **Place** the probe on the sample to test. The probe must be perpendicular to the surface ($\pm 5^\circ$). The special foot can be used to increase repeatability and reduce distortion of the results, see chapter “14. Ordering Information”.

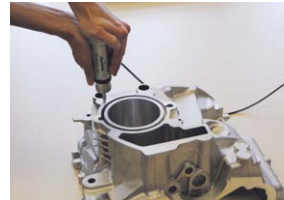

2. **Press** the probe slowly but firmly against the surface until the selected measuring force is reached. The instrument will indicate when to release the probe with an on-screen prompt and audible sound.
3. **Release** the probe from the material. It is important to remove the probe completely from the test object. Otherwise the results can be biased.

Figure 6: UCI Testing Procedure

3.1.4 Leeb U Testing Procedure

The Equotip 550 Leeb U enables the user to quickly and precisely diagnose roll imperfections, hardness inconsistencies and uneven winding, thereby preventing problems for printing and converting operations.

With Equotip Impact Device Leeb U automatic impact direction mode is not supported and the user must select the appropriate impact direction manually (90° down, 45° down, 0°).

As for roll hardness testing no conversion curves are used, no material group has to be selected.

Conduct impacts by cycling through “position and trigger”.



1. **Position** the probe on the roll to be tested. Make sure to fully position the support ring on the roll to ensure an impact perpendicular to the test surface.
2. While holding the impact device firmly with two hands, slide the loading tube smoothly down to load and **trigger** an impact.

Move the impact device to the next point on the roll and repeat.

Figure 7: Leeb U Testing Procedure



NOTE! Some features mentioned in this Operating Instructions are specifically addressing metal hardness testing applications and therefore not available for Equotip Leeb U.

3.2 Measurements Screen

3.2.1 Controls

File Name: Enter the file name and tap return. Saved measurements will be stored automatically. If filename management is activated, this function is locked.

Measurement Mode: Switch between measurement and conversion.

Time and battery status

Impact Direction: To manually set the impact direction if required (Leeb only, by default this is automatic).



Material: Select the material group to use for conversions (not available for Leeb U).

Measurement Scale: Select the hardness scale (primary and secondary) to be displayed (not available for Leeb U).

Wizards: Direct access to wizards.

Redo: Restart the measurement series or a single measurement.

Delete: Delete the last measurement.

Save: Store measurement data.

Settings: direct shortcut to settings menu. (only applicable to the actual measurement series)

Figure 8: Measurement Screen

3.2.2 Measurement Views

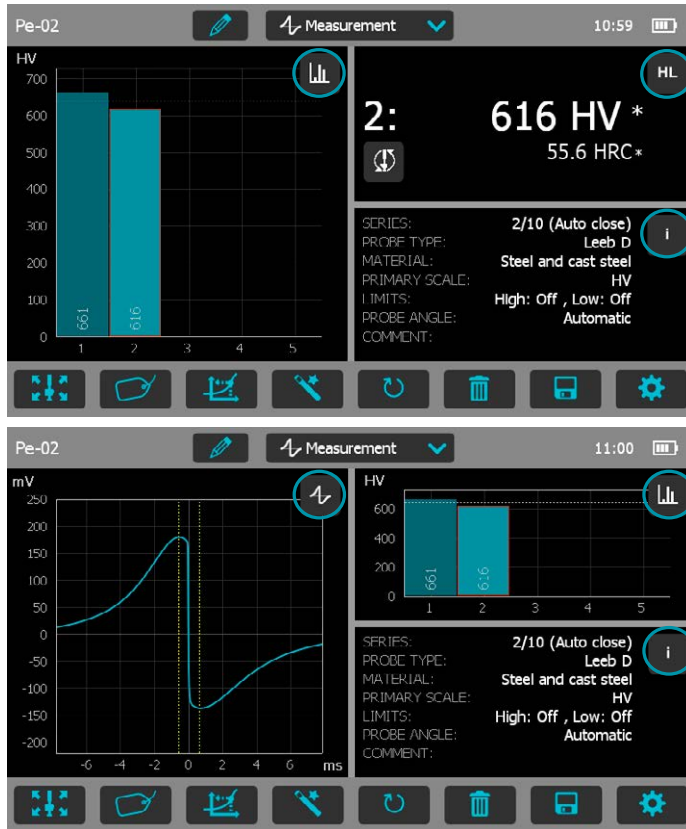

Figure 9: Measurement Views

Equotip 550 is fully customizable as a device and can display three different measurement views simultaneously. Each view can be switched to meet the user's requirements by simply clicking on the icon related to the particular display at the top right corner of each screen.



Signal View: Display the probe signal from the last active measurement. This may be useful for advanced evaluations.



Statistic View: View statistics for the active measurement series. Number of impacts (n), Average (\bar{x}), Standard deviation (σ), Minimum/Maximum ($\uparrow\downarrow$) and Range (\ddagger) are displayed in the primary scale.



Table View: Display the measurements for the active series in a table format.



Conversion View: Display the actual value on the conversion curve.



Bar View: Display the measurements of the series as a histogram.



Profile View: Display the measurement results as a profile.



Info: Display the measurement settings e.g. series length, probe type, material group etc.



User's View: The user can choose between probe angle, minimum, maximum, range and probe type for the field contents. To change, tap on each individual box.



Single Record View: Display the last or selected measurement result in both the primary and secondary hardness scales.



Sample ID's: Defines the custom field.



NOTE! Screen views cannot be duplicated.

3.3 Measuring Methods

Equotip 550 family of instruments is capable of accepting three different test methods using a single indicating unit.

3.3.1 Equotip Leeb

3.3.1.1 Test Principle

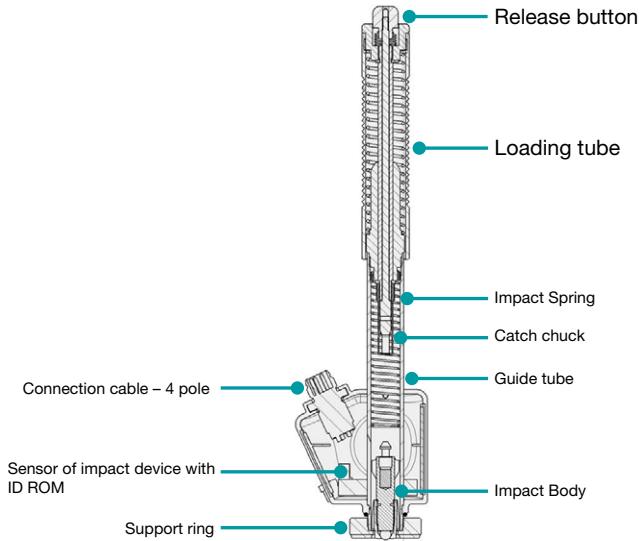

Figure 10: Schematic View of a Leeb Impact Device

During measurement with Equotip 550 impact devices (D, DL, DC, C, G, S, and E); an impact body with a ball indenter is launched by spring energy against the sample to be measured, and then rebounds. Before and after the impact, a permanent magnet inside the impact body passes through a coil in which a voltage signal is induced by the forwards and backwards movement. This induction signal behaves proportionally to the velocities. The ratio of the rebound velocity v_r to the impact velocity v_i multiplied by 1000 yields the hardness value HL (Leeb hardness). HL is a direct measure of the hardness. The third resp. fourth letter of the HL unit refers to the impact device HLD → D impact device.

$$HL = \frac{v_r}{v_i} \cdot 1000$$

Equotip Leeb U

Although the Equotip Leeb Impact Device U is constructed differently to simplify the measurement process, the underlying principle is the same.



Figure 11: Equotip Leeb U Impact Device

Existing Parotester impact devices type U are fully supported by the Equotip 550. Typ P and PG impact devices can be still used, but the unit is shown as HLU although it would be actually LP resp. LPG.



NOTE! HLU values can be directly compared to LU on existing Parotester instruments.

3.3.1.2 Sample Preparations

Keep the sample free of vibrations during the test. Light and thin parts must be specially fastened, see chapter “3.3.1.6 Testing Light Samples”. Ensure that the surface of the work piece is clean, smooth and dry. If required, use appropriate cleaning agents for cleaning, such as acetone or isopropanol. Do not use water or any other detergent fluids.



NOTE! Please use the surface roughness comparator plate provided to estimate the average roughness of the test piece prior to testing.



Figure 12: Surface Roughness Comparator Plate

3.3.1.3 Standards

Brief descriptions of referenced standards:

- DIN 50156** Leeb hardness testing of metallic materials
- ASTM A956** Standard test method for Leeb hardness testing of steel products
- ASTM A370** Test methods and definitions for mechanical testing of steel products
- ASTM E140** Standard hardness conversion tables for metals relationship among Brinell, Vickers, Rockwell, Superficial, Knoop, Scleroscope and Leeb hardness
- ISO 18265** Metallic materials – Conversion of hardness values
- ISO 16859** Leeb hardness testing of metallic materials

3.3.1.4 Test Conditions

To ensure proper hardness readings, the following conditions must be fulfilled. If one or more conditions are not met, the measurement result may be significantly false.

Impact device type		D/DC/DL/S/E	G	C	
Surface preparation	Roughness grade class ISO 1302	N7	N9	N5	
	Max. roughness depth R _a (µm / µinch)	10 / 400	30 / 1200	2.5 / 100	
	Average roughness R _a (µm / µinch)	2 / 80	7 / 275	0.4 / 16	
Minimum sample mass	Of compact shape (kg / lbs)	5 / 11	15 / 33	1.5 / 3.3	
	On solid support (kg / lbs)	2 / 4.5	5 / 11	0.5 / 1.1	
	Coupled on plate (kg / lbs)	0.05 / 0.2	0.5 / 1.1	0.02 / 0.045	
Minimum sample thickness	Uncoupled (mm / inch)	25 / 0.98	70 / 2.73	15 / 0.59	
	Coupled (mm / inch)	3 / 0.12	10 / 0.4	1 / 0.04	
	Surface layer thickness (mm / inch)	0.8 / 0.03		0.2 / 0.008	
Minimum space	Between indentation and sample edge (mm/inch)	5 / 0.2	8 / 0.3	4 / 0.16	
	Between indentations (mm/inch)	3 / 0.12	4 / 0.16	2 / 0.08	
Indentation size on test surface	With 300 HV, 30 HRC	Diameter (mm / inch)	0.54 / 0.021	1.03 / 0.04	0.38 / 0.015
		Depth (µm / µinch)	24 / 960	53 / 2120	12 / 480
	With 600 HV, 55 HRC	Diameter (mm / inch)	0.45 / 0.017	0.9 / 0.035	0.32 / 0.012
		Depth (µm / µinch)	17 / 680	41 / 1640	8 / 2560
	With 800 HV, 63 HRC	Diameter (mm / inch)	0.35 / 0.013		0.30 / 0.011
		Depth (µm / µinch)	10 / 400		7 / 280

Table 1: Leeb Test Piece Requirements

3.3.1.5 Selecting the Equotip Leeb Impact Device

For optimized testing of diverse metallic materials and sample geometries, a range of impact devices are available as per “Table 1: Leeb Test Piece Requirements”.

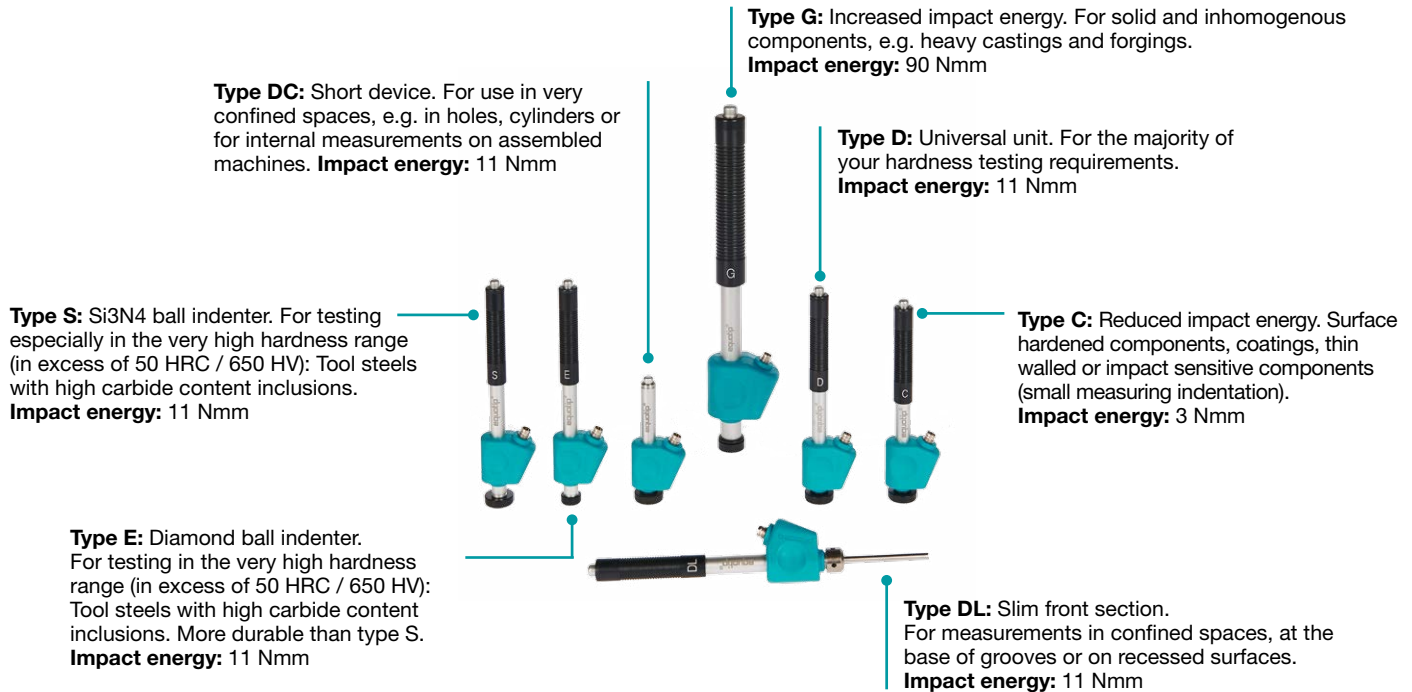

Figure 13: Equotip Leeb Impact Devices

3.3.1.6 Testing Light Samples

If the samples are lighter than specified in chapter “3.3.1.4 Test Conditions” or sample sections have unfavorable mass distribution they can vibrate as the impact body hits the test point. This results in unwanted energy absorption. Such samples shall be supported by solid worktops. If the mass falls below the specific requirements but still exceeds the coupling amount then coupling it to a larger mass can help prevent vibrations.

The following requirements must be met for coupling:

- The contact surface of the sample and the surface of the solid support must be level, flat and ground smooth.
- The sample must exceed the minimum sample thickness for coupling. Follow the coupling procedure.
- Apply a thin layer of coupling paste to the contact surface of the sample.
- Press the sample firmly against the support.
- Push the sample in a circular motion and carry out the impact as usual, perpendicular to the coupled surface.



NOTE! Clamping may strain the sample, which can affect the hardness readings.

3.3.1.7 Testing Curved Surfaces

The instrument works properly only when the ball indenter at the front of the impact body is precisely at the end of the tube at the time of the impact. When concave or convex surfaces are tested, the ball indenter does not entirely leave the test tube or comes out too far. In such cases, replace the standard support ring by a specially suited ring, see chapter “14. Ordering Information” or contact your local Proceq representative.

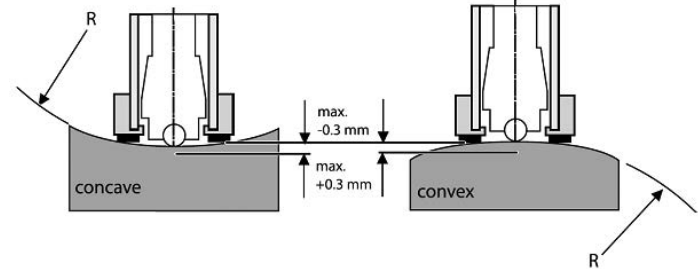

Figure 14: Leeb Testing on Curved Surfaces

3.3.1.8 Testing Thin Samples

Pipes and tubes sometimes have mass distributions that can affect the result of the Leeb hardness test due to vibration. During on-site testing of pipelines, for example the test locations cannot be supported by solid worktops or clamped.

To benefit from the convenience and speed of the Leeb test, the user can make use of a custom conversion after conducting the following calibration procedure, for example:

- Data pairs are measured on reference samples. For the Leeb HLDL reference measurements, it is crucial that they are done on parts that are installed in the same way as those to be tested on-site. For example, two pipe samples “Pipe type 5 mm Duplex soft” (730 HLDL / 255 HB) and “Pipe type 5 mm Duplex hard” (770 HLDL / 310 HB) are measured using the Equotip Leeb impact device DL and a Brinell tester, respectively.
- The original HLDL-HB conversion curve for “1 Steel and cast steel” is now adapted using the two data points. The detailed procedure on how to create custom conversion curves in the Equotip 550 is given in chapter “6.4 Conversion Curve Creation”.
- To measure “Pipe type 5 mm Duplex” in future, it can be selected via “Material” – “Pipe type 5 mm Duplex”, using the hardness scale “HB Brinell” also see chapter “6.4.3 Example of a Custom Conversion (Two-Point Method)”.



NOTE! The user needs to determine and qualify the adaptation of conversion curves for each tube diameter and wall thickness. Guides to the procedure are provided in Nordtest Technical Report Series 424, Reports 99.12/13 and ASME Final Report CRTD-91.



NOTE! It is important to include all the critical information about the geometry of the test sample.

3.3.1.9 Material Groups

No need to select any material when measuring in the native Leeb rebound scale HL as no conversion is applied. In contrast, hardness scale conversions are correct only when the appropriate material group is selected. Free online material databases and the Equotip 550 on-board reference documents can be useful to assign your materials to one of the default material groups. Suitability of conversions should be qualified on calibrated samples before use. For further information, please consult a Proceq representative.



NOTE! For a given test principle (native scale), the dropdown menu only lists the material groups for which conversions are available.



NOTE! If there is no conversion curve available, the user has the possibility to create its their own, see chapter “6.4 Conversion Curve Creation”.

			D/DC	DL	S	E	G	C
Steel and cast steel	Vickers	HV	81-955	80-950	101-964	84-1211		81-1012
	Brinell	HB	81-654	81-646	101-640	83-686	90-646	81-694
	Rockwell	HRB	38-100	37-100			48-100	
		HRC	20-68	21-68	22-70	20-72		20-70
		HRA			61-88	61-88		
	Shore	HS	30-99	31-97	28-104	29-103		30-102
	Rm N/mm ²	σ1	275-2194	275-2297	340-2194	283-2195	305-2194	275-2194
σ2		616-1480	614-1485	615-1480	616-1479	618-1478	615-1479	
σ3		449-847	449-849	450-846	448-849	450-847	450-846	
Cold work tool steel	Vickers	HV	80-900	80-905	104-924	82-1009	*	98-942
	Rockwell	HRC	21-67	21-67	22-68	23-70		20-67
Stainless steel	Vickers	HV	85-802	*	119-934	88-668	*	*
	Brinell	HB	85-655		105-656	87-661		
	Rockwell	HRB	46-102		70-104	49-102		
		HRC	20-62		21-64	20-64		
Cast iron lamellar graphite GG	Brinell	HB	90-664	*	*	*	92-326	*
	Vickers	HV	90-698					
	Rockwell	HRC	21-59					
Cast iron, nodular graphite GGG	Brinell	HB	95-686	*	*	*	127-364	*
	Vickers	HV	96-724					
	Rockwell	HRC	21-60				19-37	
Cast aluminium alloys	Brinell	HB	19-164	20-187	20-184	23-176	19-168	21-167
	Vickers	HV	22-193	21-191	22-196	22-198		
	Rockwell	HRB	24-85				24-86	23-85
Copper/zinc alloys (brass)	Brinell	HB	40-173	*	*	*	*	*
	Rockwell	HRB	14-95					
CuAl/CuSn-alloys (bronze)	Brinell	HB	60-290	*	*	*	*	*
Wrought copper alloys, low alloyed	Brinell	HB	45-315	*	*	*	*	*

*Custom conversion curve / correlation

Table 2: Overview of Available Conversions

3.3.2 Equotip Portable Rockwell

3.3.2.1 Test Principle

During measurement with Equotip 550 Portable Rockwell probe, a diamond indenter is forced into the test piece, and then released back out of the material. The indentation depth is measured continuously during this process. Indentation depth is calculated after decreasing the total load to preload.

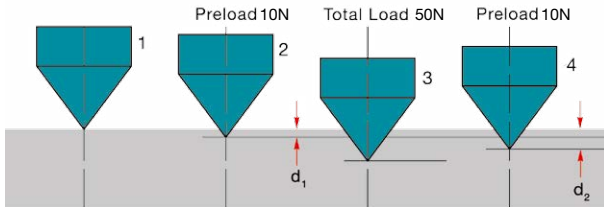

Figure 15: Portable Rockwell Test Principle

3.3.2.2 Sample Preparations

Ensure that the surface of the work piece is clean, smooth and dry. If required, use appropriate cleaning agents for cleaning, such as acetone or isopropanol. Do not use water or any other detergent fluids.

3.3.2.3 Measurement on Basis of DIN 50157

Both depth measurements d_1 and d_2 are taken at preload, first during application (d_1) then after release of the total load (d_2). The difference between d_1 and d_2 originates from the deformation response of the material to penetration.



NOTE! By calculating the penetration depth between the preload and total load, surface roughness discrepancies are significantly disregarded.



NOTE! The hardness testing principle in Portable Rockwell follows the Rockwell stationary test. As for the Rockwell test, no adjustment for the test direction is required. However, there are three main differences to traditional stationary Rockwell tests:

- The test loads are lower.
- The Portable Rockwell indenter is sharper.
- The dwell times during the test are shorter.



NOTE! “MM” stands for “mobile mechanical” measurement, an ancillary that is required by the German standard DIN 50157 to explicitly denote the lower applied loads, sharper indenter shape and shorter loading times during a measurement. The different denomination is formal, i.e. the HMMRC results should be very close if not equal to stationary HRC readings.

3.3.2.4 Test Conditions

To ensure proper hardness readings, the following conditions must be fulfilled. If one or more conditions are not met, the result may be significantly false.

Probe setup	50 N probe with clamp	50 N probe with round standard foot ($\phi = 42 \text{ mm}$)	50 N probe with tripod	50 N probe with special feet
Minimum test piece thickness	1 mm at ~20 HB 130 μm at ~70 HRC			
Maximum test piece thickness	40 mm	N/A		
Test piece surface condition	recommended mean surface roughness $R_a < 2 \mu\text{m}$ to minimize data scatter			
Surface curvature		foot to be used for plane surfaces	very small curvatures acceptable	18 – 70 mm radius of curvature or 70 mm – ∞
Maximum test piece hardness	70 HRC			
Minimum spacing	three times the diameter of a test indentation			

Table 3: Portable Rockwell Test Piece Requirements

3.3.2.5 Installing the Measuring Clamp

The clamp is designed to facilitate the hardness testing of very thin or small samples.

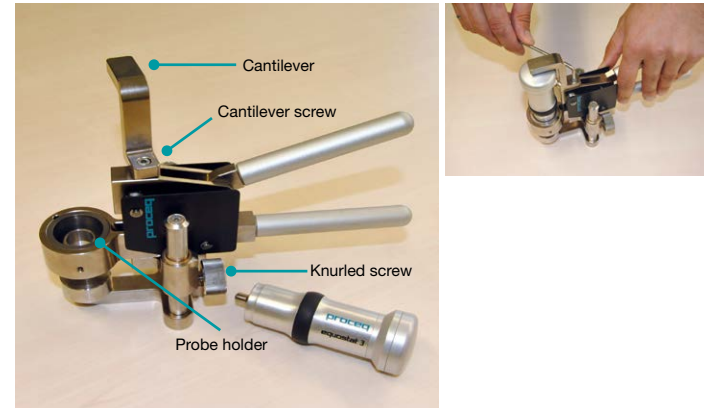

Figure 16: Portable Rockwell Clamp

- Use the 3 mm Allen key setup tool to release the cantilever. Turn it by 90°.
- Take the probe and remove the foot. The diamond indenter remains mounted.
- Screw the probe into the probe holder of the clamp clockwise (hand-tight).
- Turn the cantilever so its tip is centred over the probe; tighten the cantilever screw securely using the 3 mm Allen key setup tool.
- The recommended clearance between the bottom of the probe holder and the sample surface should be between 2 and 5 mm. Adjust the height with the two knurled screws.



NOTE! In case the probe connector is in an inconvenient position, release the set screw. Ensure that the springs in the mechanism do not get lost. Turn the mechanism into a convenient position, aligning the set screw with the guide channel. Lock the set screw so that the probe holder will still slide up and down without rubbing on the set screw.

3.3.2.6 Considerations

- When measuring cylindrical samples with adapters Z4 or Z4+28, make sure, the sample is not twisted on the clamp support. This is best ensured when the back part of the clamp rests on a table and only the sample support of the clamp sticks out over the table's edge.
- When applying the load, slowly squeeze the leavers and allow the sample to adjust to the support. During the measurement, do not touch the sample, if possible. When releasing, grab the sample again.
- Whenever the sample geometry (i.e. the wall thickness) allows it, free-hand measurements usually offer better measuring performance. This applies particularly to measurements on cylinders.
- For small diameter rods (or stiff enough pipes), the V-notch clamp adapter Z2 has been designed. When installing the Z2 support ensure that the centre of the V-notch is centred underneath the probe holder.

3.3.2.7 Installation of Standard Foot or Tripod

The round standard foot permits measurements on test objects that are only accessible from one side, such as large metal sheets. The tripod is used when the flat foot cannot be placed on the test piece without wiggling.

1. The diamond indenter remains mounted.
2. Install the foot on the probe.



Figure 17: Portable Rockwell with Tripod

3.3.2.8 Installing the Special Foot

Two special feet extend the Portable Rockwell application range to cylindrical test pieces.

1. The diamond indenter remains mounted.
2. Install the foot on the probe.
3. Place the foot on the test piece and release the set screw on the foot. Then press down the probe onto the test piece and lock the set screw.



Figure 18: Portable Rockwell Special Feet

3.3.2.9 Conversion Standard

Measurements in HV and HRC are direct correlations therefore no conversion is required. The user has the option of either ASTM E140 or ISO 18265 for conversion to any other scales.

3.3.2.10 Material Groups

Since Portable Rockwell is based on static indentation principle, the hardness conversions are less dependent on material specific properties for the majority of times.

The user still has the possibility to apply customer conversion curves if required, see chapter "6.4 Conversion Curve Creation".

3.3.3 Equotip Ultrasonic Contact Impedance (UCI)

3.3.3.1 Test Principle

The UCI method uses the same pyramid-shaped diamond as a conventional Vickers hardness tester. Unlike Vickers testing, no optical evaluation of the indentation is required, enabling fast and portable measurements. The UCI method excites a rod into an ultrasonic oscillation. The test load is applied by a spring and typically ranges from 1 to 5 kg of force (HV1 – HV5). As the diamond is forced into the material, the frequency of the rod oscillation changes in response to the contact area between the diamond and the material under test. The instrument detects the shift in frequency, converts it to a hardness value which is immediately displayed on the screen.

3.3.3.2 Sample Preparations

Ensure that the surface of the work piece is clean, smooth and dry. If required, use appropriate cleaning agents for cleaning, such as acetone or isopropanol. Do not use water or any other detergent fluids.

3.3.3.3 Standards for UCI measurements

There are two standards which describe the UCI measurements, resp. the instrument:

DIN 50159	Hardness testing with the UCI method
ASTM A1038	Standard test method for portable hardness testing by the Ultrasonic Contact Impedance method

For conversions from one hardness unit to another, the user can chose between the following standards:

ASTM E140	Standard hardness conversion tables for metals relationship among Brinell, Vickers, Rockwell, Superficial, Knoop, Scleroscope and Leeb hardness
ISO 18265	Conversion of hardness values

3.3.3.4 Test Conditions

To ensure proper hardness readings, the following conditions must be fulfilled. If one or more conditions are not met, the result may be misleading.

Probe setup		HV1 (~10 N)	HV5 (~50 N)
Minimal required thickness		5 mm / 0.2 inch	
Minimal required weight		0.3 kg / 0.66 lbs	
Required surface roughness	Grade class	N8	N10
	Maximum roughness	15 μm / 600 μinch	60 μm / 2400 μinch
	Average roughness	3.2 μm / 125 μinch	12.5 μm / 500 μinch
Acceptable surface curvature		Radius > 3 mm	
Minimum space	Indentation to edge	5 mm / 0.2 inch	
	Between indentations	3 mm / 0.12 inch	
Indentation size on test surface			
300 HV, 30 HRC	Depth	11.3 μm / 445 μinch	25.3 μm / 996 μinch
	Diagonal	79.1 μm / 3114 μinch	177.1 μm / 6972 μinch
600 HV, 55 HRC	Depth	8 μm / 315 μinch	17.9 μm / 705 μinch
	Diagonal	56 μm / 2205 μinch	125.3 μm / 4933 μinch
800 HV, 63 HRC	Depth	6.9 μm / 272 μinch	15.5 μm / 610 μinch
	Diagonal	48.3 μm / 1900 μinch	108.5 μm / 4272 μinch

Table 4: UCI Test Piece Requirements

3.3.3.5 Installation of the Special Foot



The default foot allows the measurement to be performed on every surface. The probe must be perpendicular to the surface ($\pm 5^\circ$). The special foot can be used to increase the repeatability and avoid the distortion of the results, see chapter "14. Ordering Information".

1. Unscrew the standard foot and remove it
2. Screw the special foot to the probe tightly



NOTE! To measure in places with limited accessibility, the probe can be used without any foot. If doing so, the side of the rod of the probe must not touch any surface or be handled, as this leads to biased readings.

3.3.3.6 Conversions into Other Units

The frequency shift measured by the UCI probe is not only influenced by the hardness, but also by its elastic properties. The default conversion curve from the frequency shift to Vickers is valid for low-alloyed steel with an e-modulus of 210 ± 10 GPa. As soon as a material has to be tested with a different e-modulus, this existing conversion curve must be adapted. The best way to do so is to calibrate the instrument on the material to be tested. The Equotip 550 offers for this a fast and easy way. Once the hardness value is converted to Vickers, it can be further converted to any other available hardness unit according to either the ASTM E140 or the ISO 18265. Another option is to adjust the default conversion based on the measurement of Portable Rockwell or Leeb. To do so, see chapter "6.5 Combined Method".

3.4 Instrument Verification / Daily Performance Check

See chapter "6.2 Device Verification" and follow the on-screen procedure. After the verification process your instrument is fully operational and you can now continue with your measurements.



NOTE! The performance check should be done regularly before using the instrument to verify the mechanical and electronic functions of the probe and the indicating device. This requirement is also included in the relevant hardness standards, see chapter "13. Standards & Guidelines".

4. Settings

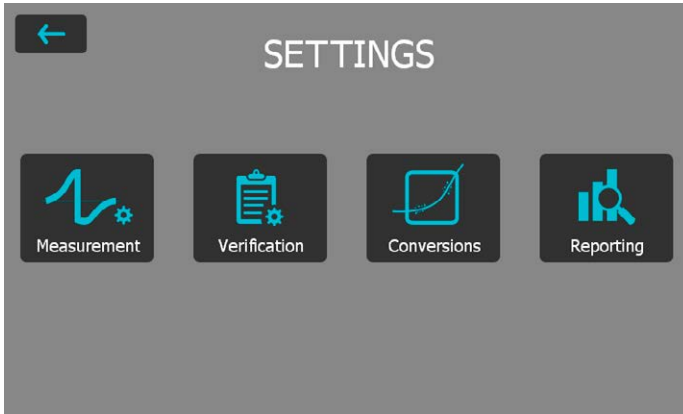

Figure 19: Settings Menu

4.1 Measurements

If changes are made here, they are set for all the upcoming measurement series. If the settings menu is accessed through the measurement screen, changes are only valid for the actual measurement series.

4.1.1 Probe Type

Probe types are automatically recognised by the device. Default settings can be set and will be used for each measurement device. If the measurement settings are accessed from the measurement screen, the active probe can be selected.

4.1.2 Test piece management (Coming Soon)

Complete sets of settings can be managed in this menu. It allows the user to save, edit, recall or delete these sets. This can be used to have a quick access to different measurement settings, i.e. for different test pieces or applications.

4.1.3 Measurement Parameters

Material

The desired material group can be selected from the default list, in addition you may predefine custom material groups which will be displayed here. For custom material/curves please refer to chapter “6.4 Conversion Curve Creation”. For more information on material groups related to Leeb please refer to chapter “3.3.1.9 Material Groups”, for Portable Rockwell chapter “3.3.2.10 Material Groups” and for UCI “3.3.3.6 Conversions into Other Units”.

Primary and Secondary scales

The user has the possibility to select two different scales in which the measurement results are displayed.



NOTE! Conversion for HLD to HV, HB and HRC are standardized as per ASTM E140. Conversion for Portable Rockwell (μm) and UCI can be switched between ASTM E140 and ISO 18265).



NOTE! Equotip Leeb Impact Device U does not support conversion curves, therefore these settings are not available.

Conversion Standards – Leeb

The conversion standard for Shore hardness HS switched between the default conversion according to ASTM E448 or the Japanese conversion according to JIS B7731.



NOTE! Measurements for certain types of Steel can be converted to tensile strength according to DIN EN ISO 18265.

Conversion Standards – Portable Rockwell

The default measuring method DIN 50157, is applicable for testing all metallic material, and it generally yields more consistency. For conversions, user has the choice to select either ISO or ASTM.

Conversion Standards – UCI

The default measuring method is according to ASTM A1038 and DIN 50159. For conversions, the user has the choice to select either ISO or ASTM.

Impact direction (Leeb only)

With exception to DL and U devices all Leeb impact devices have automatic direction compensation. You may override this and set the impact direction manually. For more information on impact direction please refer to chapter “3.1.1 Leeb Testing Procedure (except Leeb U)”. Impact direction is not relevant to the Portable Rockwell and the UCI devices.

Trigger Load (UCI only)

For the Equotip UCI probe the load where the measurement will be triggered can be chosen in the range from HV1 to HV5 (10 – 50 N). The trigger load cannot be changed once the measurement series was started.

Units (Portable Rockwell only)

For Portable Rockwell probe, choose to display the indentation depth in metric or imperial units.

4.1.4 Sample IDs

After Measurement

Use this setting to define if the current sample ID's should be kept for the next measurement series or deleted.

Edit Entries

The entries of the different sample ID fields can be deleted or edited here. For easy increasing or decreasing, use the up- and down- arrows. For adding or removing entry fields, please see chapter “8.1.2 General Features”.

4.1.5 Workflow

Activate User Guidance

Select to display on screen instructions and messages when taking a measurement.

Use Advanced Algorithm (Portable Rockwell only)

Advanced Algorithm provides faster measurements. This is especially useful when testing softer material.

Auto Close Series

Automatically end a series after a set number of measurements. The user can set the series from 1 to 1000 measurements.

Measurement Comment Handling

Use this setting to allow or disallow the user to enter a comment at the completion of a measurement series. When set to “free” this enables the user inputting a comment.

Measurement Series Filename

Enter the file name for the measurement series will be stored. This possibility is disabled, if filename management is activated.

Save to Folder

Set the folder location where the measurement series file to be stored. This option is disabled, if folder management is activated.

Store Signal Data (Leeb only)

Select to store the raw waveform for Leeb measurements. For Portable Rockwell the signal form will be stored for each measurement automatically, for UCI this option is not available.



NOTE! Storing signal data will cause measurement files to take up more memory.

Enable Warnings

Choose to enable warning display signals and sounds to indicate false measurements.

Use report templates

Here a template for the report can be selected. By default, the default template will be used. This default template can be selected in the template manager.

Operator

Here the test operator can be edited. This operator name is stored for the following measurements, but not for the verifications.

4.1.6 Limits

Enable Upper and Lower Limits

Select to enable the display of the upper and lower tolerance limits for the measurements. Specific color coding is adopted to differentiate between upper and lower limits.

4.2 Verification (Performance & Uncertainty Check)

To see how a verification can be performed please refer to chapter “6.2 Device Verification”.

4.2.1 Test Block Management

It is important to verify the correct functionality of the instrument on a testblock calibrated in the genuine native scale of the probe being used. In the test block management section, different test blocks information can be stored. Test blocks that are listed here can then be used during the verification process.

4.2.2 Workflow

Standard

Select the standard according to which the verification should be performed. It can be selected between ISO, ASTM or a customer defined standard.

Minimum series count

The minimum required number of measurements can be selected here. If a standard was selected before, this setting is fixed.

Maximum series count

The maximum allowed number of measurements can be selected here. If a standard was selected before, this setting is fixed.

Operator reference

Here the reference operator name can be entered if required. This name will be used for the verification processes. If no name is entered here, the user can still enter it during the verification process.



NOTE! First time user: It is recommend to complete a “Tutorial on Leeb and Portable Rockwell Hardness Testing” as appropriate or watch a demonstration by a qualified Proceq representative.



NOTE! The performance check should be done regularly before each use of the instrument to verify the mechanical and electronic functions of the impact device and the indicating device. This requirement is also included in the DIN and ASTM Leeb hardness standards, see chapter “8.1 Features”.

4.2.3 Verification Standards and Extended Uncertainty

It is recommended for the instrument to be verified prior to testing. This gives the user the extra assurance that the device is working correctly and the measurement data are accurate. Although the verification process is similar on all Leeb, Portable Rockwell (mechanical penetration depth) and UCI standards, user has the option to comply with the preferred standard/verification procedure.

DIN 50156	Leeb hardness testing of metallic materials. Will be replaced by ISO 16859.
DIN 50157	Hardness testing of metallic materials with portable measuring instruments operating with mechanical penetration depth.
DIN 50159	Hardness testing with the UCI method.
ASTM A956	Standard test method for Leeb hardness testing of steel products.
ASTM A1038	Standard test method for portable hardness testing by the Ultrasonic Contact Impedance method
ISO 16859	Hardness testing of metallic materials by Leeb.
Extended Uncertainty (Combined Uncertainty)	Measurement uncertainty analysis is applied to understand the differences in test results and to determine sources of error. The uncertainty of an Equotip Leeb, Equotip Portable Rockwell or Equotip UCI hardness testing system consists of a statistical component, a component inherent to the measurement device and a component arising from the metrological chain between national standard and the user device (traceability). Although uncertainty could be a complicated topic, Equotip 550 automatically calculates the combined uncertainty of the system. All the required information is already available in the calibration certificates provided by Proceq. Therefore the device only requires adding these values in the specified fields and following the simple steps on the display in order to complete the process.

4.3 Conversions (Hardness Conversions)

There is no direct correlation between any two hardness scales. Therefore conversions must be determined by comparison testing for any given alloy.

4.3.1 Standard Conversions

Proceq has developed correlations to convert the Leeb hardness measurements to other commonly used hardness scales based on groups of alloys that have a close relationship. The conversions for HLD and Material Group 1 (Carbon Steels) are standardized according to ASTM E140-12b.

4.3.2 Custom Conversion Curves

See chapter “6.4 Conversion Curve Creation”.

4.3.2.1 Custom Compensation

In some cases a user must measure hardness on many samples with identical size and shape that is below the ideal limits for accuracy. Studies have been published by ASME and Nordtest that have identified and confirmed the validity of the strategy to apply a compensation factor to correct for the inaccuracies induced by the non-ideal geometry. The methods outlined in chapters “6.4 Conversion Curve Creation” can be applied to create this compensation factor to be applied automatically to the Equotip test result.

4.4 Reporting

The content of the measurement reports can be adjusted here.

4.4.1 Images Explorer

Images, i.e. company logos can be loaded from an USB stick on the device, for use in reports. Pictures must be in the *.png or *.jpg format, ideally come with 72dpi and a maximum resolution of 496x652 pixel.

Upload Images from an USB-stick

To do so follow the steps below.

- Create the folder “PQ-Import” in the main directory of the USB-stick (not as a subfolder in another folder) and fill it with all the picture-files to be uploaded to the Equotip Touchscreen

- Connect the USB-stick to the USB Device plug on the left side of the Equotip Touchscreen
- Click on  and confirm with click on 
- The uploaded images appear in the Images Explorer



NOTE! The USB stick must be either formatted in FAT or FAT32. NTFS is not supported.

4.4.2 Report template explorer

The report templates can be managed here. Either the default template can be used, or a fully customized template can be created and edited. Templates can also be copied or exported to an USB stick.

4.4.3 Reporting via PDF

It's possible to create reports directly on the instrument as PDF and store them on USB stick. Choose the measurement files in the data explorer of which a report should be created, mark them by ticking the box. Tap the  button to create the reports. The report will be created with the selected report template. Repeat this for each file. For each measurement series there will be a separate PDF created.



NOTE! The report option is only visible if an USB stick is connected to the instrument. The USB stick must be either formatted in FAT or FAT32. NTFS is not supported.

Optionally, also the project file can be exported to the USB stick. Here all files will be included in one file.

4.4.4 Reporting via Equotip Link

Alternatively to create reports the PC-Software Equotip Link can be used. For more details please refer to chapter "11. Equotip Link Software".

5. Data (Explorer)

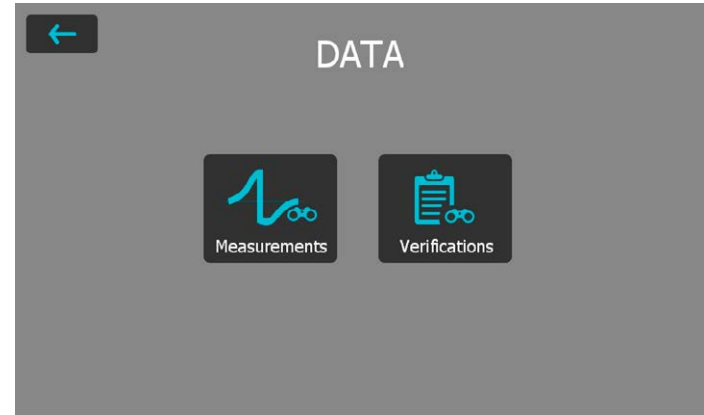



Figure 20: Data Explorer Menu

5.1 Measurements

5.1.1 Storing Measurements

If the auto close option is disabled or chosen number of impacts is not reached, the series can be closed and saved manually by tapping the store button .

If the auto close option is enabled, the measurement series will be automatically stored as soon as the chosen number of impacts is reached.

The name under which the series will be stored can be edited in the upper left corner.



NOTE! If the file name already exists, the name will be extended by a number and increased with every additional file.

The stored measurements can be organized in folders, by tapping the Data Explorer button on the new folder option

Enter the name of the new folder and confirm by tapping on the back button in the upper left corner.

The folder in which new measurements are stored can be selected under Settings → Measurement → Save to Folder.

5.1.2 Data Explorer

From the main menu select Data → Measurements to review and manage saved measurements data.

Each folder and measurement series is shown as one line in the explorer view.

For each series the probe used, mean value of the series, series name, date & time of the measurement can be seen.

The list can be sorted by tapping on the corresponding header. The small arrow indicates which list is sorted.

Tap on a saved file to open it and return to the Data Explorer list by pressing the back button.

Mat	Val	Name	Date & Time
		Test Patrick	30-04-2015 11:16
MG1	778.9	Pe-02	15-07-2015 11:01
MG1	680.7	Pe-01	29-05-2015 11:19
MG1	788.6	Pe-01	26-06-2016 11:06

Figure 21: Measurement View in Data Explorer

5.1.3 Review of Data

In the detailed view of a measurement series, all information can be seen and the settings are editable.

All the different views can be switched according to the users needs.

For more details about the different views, please refer to chapter “3.2.2 Measurement Views”.



5.1.4 Delete Files

From stored measurement files, single impacts can be eliminated afterwards. To do so, open the measurement series, tap the value to eliminate and tap delete button

Whole measurement files can be deleted in the Data Explorer. To do so, tap on the box of the appropriate files to select and all selected files can be deleted by tapping the delete button

To erase all data stored on the instrument, in the root folder tap on the box on the left end of the header row then tap the delete button



5.1.5 Copy Files

To copy measurement series, select the file and click on the  icon. Go to the folder where the copy should be created and tap the  icon to paste the file. When copying a file all attributes will be duplicated



NOTE! The file cannot be added in the same folder!

5.1.6 Cut & Paste Files

To move existing measurement series from one place to another, set the tick of the corresponding file and tap on the  icon. Go to the folder where the file should be moved in and tap the  icon to paste the file

5.2 Verifications

From the main menu select “Data”, and then “Verifications” to review and manage saved verification data “6.2 Device Verification”.

The verification data is stored and managed in the same manner as the measurement data. Except no deletion is allowed.

Each folder and measurement series is shown as one line in the explorer view.

Additionally the result for each verification data series, either a “passed” or a “failed” is displayed.

6. Wizards

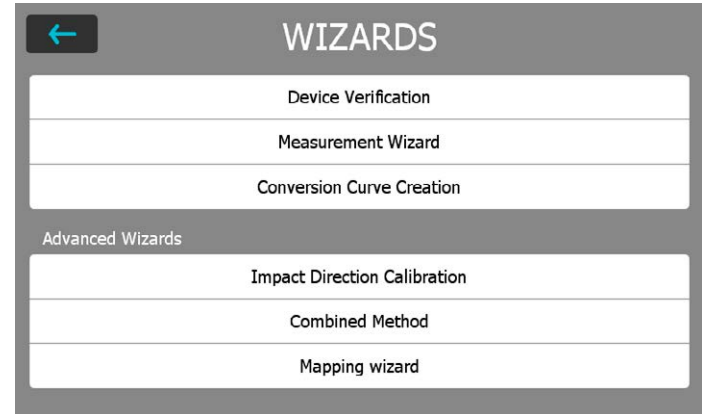

Figure 22: Wizards Menu

Wizards are a unique feature of Equotip 550. These simple step-by-step instructions are for the majority of users, no matter how experienced they are. Interactive wizards help speed up the workflow and improve the measurement’s reliability.

All settings concerning wizards can be edited in the System → User Settings. Also see chapter “8.1 Features”.



NOTE! For Equotip Leeb Impact Device U only the “Device Verification” wizard is available.

6.1 Measurement Wizard

This particular wizard helps define the best measurement principle e.g. impact device to fit the application, simply based on sample geometries and surface conditions. To start, some basic information must be provided to define the test piece. When information is evaluated by the device a series of recommendations are displayed in order of their relevance to the application in question.

After the initial process is complete, the device recommends the appropriate probe, scope of application and preparation information. Settings will then be adopted and the intelligent measurement process begins.



NOTE! Please verify that correct series number, impact direction, material group, scales and limits are defined as well as sub file and folder name.

6.2 Device Verification

During the verification process, the user will be guided through the entire procedure. At the end of the procedure the instrument is considered verified and the data is stored in the device memory. Verification data is also stored as the verification is performed, therefore any discrepancies occurring over time will be noticeable.



NOTE! This wizard can also be started from the menu System → Probes.



NOTE! A Proceq reference test block is required to complete this wizard successfully.

6.3 Impact Direction Calibration (Leeb only)

Each Leeb impact device requires a calibration in order to automatically compensate for impact direction. This is easily achieved using this wizard.



NOTE! All impact devices are already factory calibrated when shipped, however based on the usage and application it is recommended to recalibrate the impact direction prior to verification process chapter “6.2 Device Verification”. If this process is not completed currently inaccurate data may be obtained.



NOTE! This wizard can also be started from the menu System → Probes.

6.4 Conversion Curve Creation

When default conversions are not suitable for the material being tested, it is recommended to create a customized conversion/correlation. This wizard guides the user through the complete process in a simple manner and provides all the necessary information on comparative measurements.

This creates a brand new conversion curve which is used for any future measurements on the material in question.

6.4.1 Minimizing Conversion Errors

Conversion errors will not normally exceed ± 2 HR for Rockwell scales and ± 10 % for Brinell and Vickers provided the material group is selected correctly. In most cases, the conversion error is significantly lower. If higher accuracy is required or if the alloy under test is not covered by one of the standard conversions, the Equotip 550 provides a variety of methods to define material-specific conversions.

6.4.2 Methods for Setting Up Custom Conversions

The Equotip 550 provides three techniques to accomplish custom conversions, each can be used for all of the three different measuring principles (example HLD → HRC):

One-point method: The Leeb hardness HLD and the hardness in the desired scale (i.e. HRC) are determined for a reference work piece. A standard conversion function HLD-HRC is then adapted through vertical offset until the measured reference data pair lies on the shifted curve.

Two-point method: Two reference samples are tested, one as soft and one as hard as possible to find two data pairs (i.e. HLD / HRC). A standard conversion function HLD-HRC is then adapted through adding a straight line until both of the measured reference data pairs lie on the tilted curve.

Conversion polynomial: If a custom conversion needs to be applied throughout a wide hardness range, several reference samples shall be tested to find a stable basis for interpolation. Up to 5th order polynomials can be programmed into the Equotip 550 indicating device by defining the polynomial coefficients A_i in

$$HRC(HLD) = A_0 + A_1 \cdot HLD + A_2 \cdot HLD^2 + A_3 \cdot HLD^3 + A_4 \cdot HLD^4 + A_5 \cdot HLD^5$$

see Equotip Technical Guide under Information → Documents or in the download section of the Proceq website.



NOTE! When using a polynomial conversion of a higher order, please make sure to have the coefficients with sufficient digits to avoid inaccuracies in calculations.

6.4.3 Example of a Custom Conversion (Two-Point Method)

The data pairs (640 HLD / 41.5 HRC) and (770 HLD / 54.5 HRC) were measured on two reference samples made from “special steel”.

To measure “special steel” in the future using an adapted HLD-HRC conversion, the original HLD-HRC conversion curve for “1 Steel and cast steel” is tilted using the two data points. In this example, the special conversion is defined as valid for the range 41 to 55 HRC.

Once this curve has been created, it can be selected via material group “Customer defined” – “Special steel”, using the hardness scale “HRC Rockwell C” also see chapter “3.3.1.8 Testing Thin Samples”.

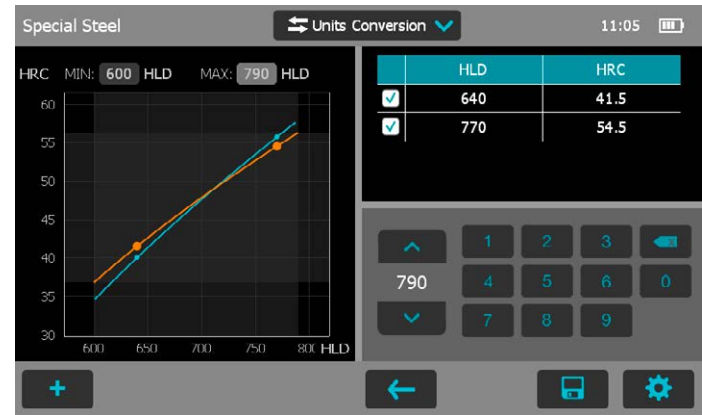

Figure 23: Two-Point Conversion

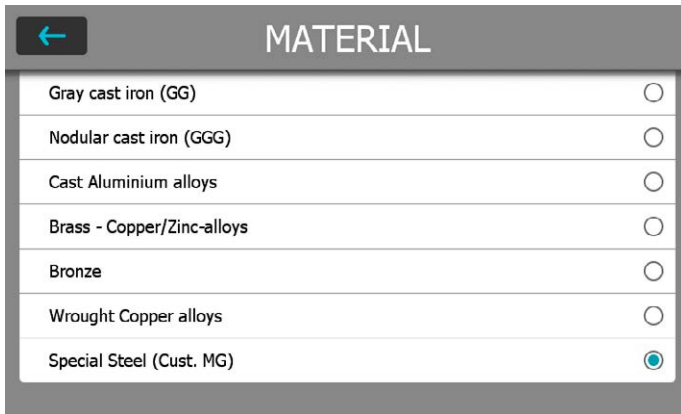

Figure 24: Custom Conversion Menu

6.4.4 Measuring Reference Samples

Sample surfaces must be prepared very carefully and if possible, sample shall meet the specific geometries to avoid coupling method.

The functioning of the Equotip 550 shall be verified against the Leeb test block prior to each measurement series.

The functioning of the static hardness testing machine (HMMRC, HV, HB, HRC etc.) shall be verified against respective test blocks of the corresponding measuring scale and range.

To obtain a pair of comparative values, the mean value from at least 10 HL measurements and at least 3 values from the static test shall be calculated. These values shall be obtained from proximate positions in a small measuring area depending on application.

6.5 Combined Method

The existing default hardness conversions in Equotip Leeb devices are based on specific sample geometries. A Portable Rockwell probe has almost no restriction with regard to thickness and mass. For samples that don't meet the Leeb specification, a simple custom correlation based on the Portable Rockwell measurements enables the user to apply a correction factor and create a new hardness conversion. This is one example where the combined method is used to fit one measuring method with the help of another one, for an application which is not covered by the default setup. But there are several other occasions where this helpful tool offers great help. This can be achieved following the combined method wizard on the Equotip 550. This wizard allows the combination of the Leeb and Portable Rockwell, the UCI and Portable Rockwell and also the combination of UCI with Leeb method. In each combination the later mentioned method is the reference method.

This wizard guides the user in five simple steps through the whole process, and finally creates the conversion curve. For other applications it can be used accordingly. For more information please see the "Equotip Application Guide" on the Proceq homepage.

6.6 Mapping Wizard (Coming Soon)

The mapping wizard allows the user to create a 2-dimensional map with readings. This is used to 'scan' a whole area. This wizard guides the user in the whole process from defining the area, through the measurements up to the final measuring report.

7. Information

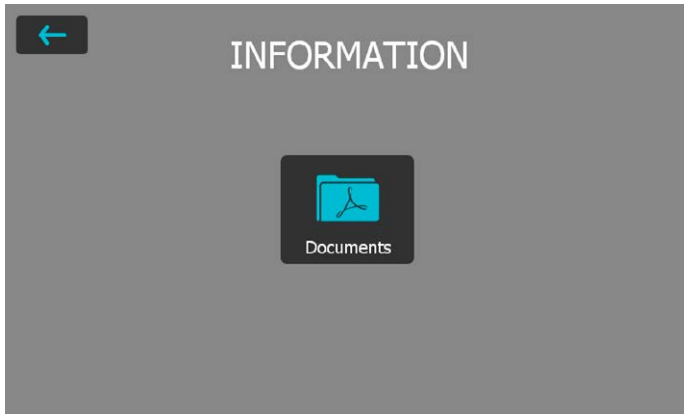

Figure 25: Information Menu

7.1 Documents

All documentation files are stored in this section of the instrument and can be viewed directly when required.

- **Quick Start Guide:** Gives an overview on the instrument including scope of delivery.
- **Operating Instructions:** This document.
- **Certificates:** Certificates applicable to this product.
- **Application Booklet:** In-depth technical information on the different measurement principles, its standards, influence of elevated temperatures, heavy use instructions and more.



- **Platform Remote Control Package:** Instructions are given on how the instrument can be used with the remote control, i.e. for automation etc.
- **More documents** may be added at a later date.



NOTE! The last viewed document can be quickly accessed by pressing the “Soft Key”. For more information see chapter “2.1 Installation”.

7.2 Upload PDF-Files from an USB-stick

Additional documents in the PDF format can be stored on the instrument. To do so follow the steps below.

- Create the folder “PQ-Import” in the main directory of the USB-stick (not as a subfolder in another folder) and fill it with all the pdf-files to be uploaded to the Equotip Touchscreen
- Go to Information/Documents
- Connect the USB-stick to the USB Device plug on the left side of the Equotip Touchscreen
- Click on  and confirm with click on 
- The uploaded PDF-files appear on the bottom of the document list



NOTE! The USB stick must be either formatted in FAT or FAT32. NTFS is not supported.

8. System

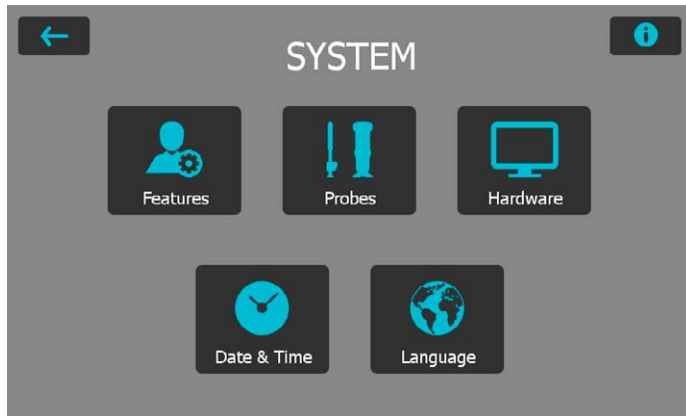

Figure 26: System Menu

8.1 Features

8.1.1 Device Lock Settings

Lock/Unlock: Select this to lock the instrument and protect it from unintentional changes.

Password: A password can be set for the lock/unlock function. If this field is left empty, no password is required to unlock the user settings.

8.1.2 General Features

Measurement Wizard: There are three options available on how the measurements wizards are enforced.

Verification Notification: Verification of the instrument can be set to forced, optional or disabled. When set to disabled the user will not be forced to perform an indirect verification. The setting “optional” is just a reminder. If “forced” or “optional” is selected, an entry appears where the verification interval may be chosen.

Custom Fields: The custom entry fields can be edited here. Beside the five default fields which cannot be deleted, additional 20 fields can be added.

8.1.3 Data Management

Use Folder Manager

Activate this option to use automatic folder management as configured in the Folder Manager.

Folder Manager

Here the desired path can be edited. A maximum of four subfolders can be created with selectable information. As soon as one of this information changes, a new folder will be created automatically.

Use File Manager

Activate this option to use automatic file naming as configured in the File Manager.

File Manager

An automatic name can be configured here consisting of four different information fields.

Long Filename Viewing

Choose here between a full view of the filename, or if only a selected range should be displayed in the measurement screen. This setting influences only the name on the measurement screen, but not in the explorer or reports.

8.1.4 Probe Features

For each probe type there is an option to protect its settings. Furthermore, for each probe type the different features to protect can be selected.

Factory reset: Select the options to delete all relevant data from the device.



NOTE! This step cannot be undone, deleted items are permanently destroyed!

8.2 Probes

Information about the connected probe can be viewed here.

Angle calibration (Leeb only): The angle calibration for this particular probe can be redone. This calibration can be done only for Equotip Leeb Impact Devices.

Verification: Verification measurement series can be started here.

To see information about other used probes, tap on the  button.

Probe Serial Number (only for Leeb U): As the serial number can not be recognized automatically, the user has to enter it manually here.

8.3 Hardware

General settings about the user interface and power options can be edited here.

Sound: The volume of the audio notifications of the instrument can be adjusted respectively switched off.

Display: The user can adjust the brightness of the display backlight.

Power: The time after when the instrument dims the display, or shuts down can be adjusted, for both battery and AC powered operation.

8.4 Date & Time

Date and time is set in this submenu. The format of these settings and the time zone can also be modified.

8.5 Language

The language setting of the instrument can be selected. Eleven different languages are available. The language of the help file is the same as for the rest of the menu.

8.6 Device information

Tap the info button  in the upper right corner to view all the information related to the device e.g. name, version and serial number can be found in this section as well as battery status. On this information page the IP address (if ethernet is connected and a DHCP server is available) and the instruments MAC address will also be shown.

9. Maintenance and Support

9.1 Maintenance

The instrument should be calibrated annually to ensure consistent, reliable and accurate measurements. However, the service interval may be based on actual experience and usage. Consult the applicable standards for more guidance.

9.1.1 Regular Device Check

Performance checks, see chapter “4.2 Verification (Performance & Uncertainty Check)” of the instrument should be carried out at least once a day or at the latest after 1000 impacts. In the case of infrequent use, carry out the check before the beginning and at the end of a test series. In addition, have the device calibrated by an authorized Proceq Service Center once a year.



NOTE! The unit is working properly when the average is within the target range. Otherwise, please see chapter “10. Troubleshooting”.

9.1.2 Cleaning

Leeb Impact device: Unscrew the support ring. Remove the impact body from the guide tube. Clean the guide tube with the cleaning brush. Reassemble.

Leeb Indenters: Clean the ball of the Leeb impact bodies and Portable Rockwell diamond indenter with acetone or similar solvent. (Do not use water or water based detergents!)

Portable Rockwell and UCI probes: Clean the probes and the diamond indenters with a clean, dry cloth.

Housing: Clean the display and housing with a clean, dry cloth after use. Also clean the connector sockets with a clean, dry brush.



NOTE! Never immerse the device in water. Do not use compressed air, abrasives, solvents or lubricants to clean the device.

9.1.3 Storage

Only store the Equotip 550 in the original packaging and in a dry room free of dust.

9.1.4 Re-calibration for Impact Direction (Leeb only)

For Leeb impact devices the compensation function relies on parameters specific to each impact device, which are stored in the device. Validity of the active calibration can be checked through System → Probes → Angle Calibration and then pressing the “Test” button. For each impact direction, the deviation from the curve shall be less than ± 0.2 Leeb (HL).

The parameters may change with time or due to external influences. Re-calibration of the automatic compensation function in Equotip Leeb impact devices (except type DL) is recommended particularly when:

- Impact device has been cleaned, or
- Impact device has not been used for a long time, or
- Impact body has been replaced.

A re-calibration is done by consecutive selection of “0° (vertical down)”, “90° (horizontal)” and “180° (vertical up)”.

9.1.5 Updating the Equotip 550 Operating System and Application

Connect the device to the computer. Updates can be done using Equotip Link as follows:

- Select update symbol  in Equotip Link
- Select “Express” and confirm with “Next”.

- Select the device type and confirm with “Next”.
- In the “Choose Communication Type” dialog box, select the type of communication used between the Equotip and PC, and then click “Next”.
- In the “Device search result and selection” dialog box, make sure the serial number of the device in the drop-down field is the device to be updated, and then click “Next”.
- PqUpgrade will now search the Proceq servers for any available updates. To do so, a working internet connection is required.
- Follow the on-screen instructions to finish the update.



NOTE! Although saved data is not deleted during the update process, it is recommended to save the stored data in before updating the firmware.



NOTE! The “Custom” update is recommended for advanced users only.

9.2 Support Concept

Proceq is committed to providing a complete support service for this instrument by means of our global service and support facilities. It is recommended that the user register the product on www.proceq.com to obtain the latest on available updates and other valuable information.

9.3 Standard Warranty and Extended Warranty

The standard warranty covers the electronic portion of the instrument for 24 months from the date of purchase. The mechanical portion of the instrument is covered by warranty for 6 months. An extended warranty for an additional one, two or three years for the electronic portion of the instrument may be purchased up to 90 days from the date of purchase.

9.4 Disposal



Disposal of electric appliances together with household waste is not permissible. In observance of European Directives 2002/96/EC, 2006/66/EC and 2012/19/EC on waste, electrical and electronic equipment and its implementation, and in accordance with national and local law, electric tools and batteries that have reached the end of their life must be collected separately and returned to an environmentally compatible recycling facility.

10. Troubleshooting

10.1 Incorrect Measurements / Failed Performance Check

10.1.1 Leeb

During the performance check, if the average deviates from the set point value by more than ± 6 HL (for Leeb U ± 12 HLU):

- Check first that the test block is clean, smooth and dry. See chapter “3.3.1.2 Sample Preparations”. Replace the test block if there is insufficient space for additional tests.
- Clean the impact body, paying close attention to the indenter ball at the bottom and to the catch pin at the top of the body. Replace the impact body if necessary.
- Clean the impact device.
- Check the mounting and wear of the support ring. Check for deposits. Clean or replace if necessary.
- The incorrect material group, hardness scale or a wrong setting for the impact direction may have been selected. Refer to chapter “4. Settings”.
- The selected hardness scale is not in the permissible range (no conversion). Select another scale.
- Check if individual values are scattered very widely or are continuously too low.
- The impact is triggered while the device is not held vertically on the surface. This may occur especially when using impact device DL. Try using the plexiglass sleeve DL for better alignment.
- Sample is insufficiently supported. Prepare the sample for the impact e.g. through use of the coupling method, see chapter “3.3.1.6 Testing Light Samples”.
- If the instrument still shows excessive deviations: return the device to an authorized Proceq Service Centre for recalibration / inspection.



NOTE! Do not resurface test blocks or try to refurbish impact bodies. This will impair accuracy and may also deteriorate functionality of the Equotip 550.

10.1.2 Portable Rockwell

During the performance check, if the average deviates from the set point value by more than ± 2 HRC:

- Confirm the foot is seated securely on the probe or the probe securely in the clamp, respectively.
- Clean the indenter, paying close attention especially to the front part (diamond) and to the screw thread.
- Check that the test block is clean, smooth and dry. See chapter “3.3.2.2 Sample Preparations”. Replace the test block if there is insufficient space for additional tests.
- Check the mounting and wear of the stand and clamp. Check for deposits. Clean or replace if necessary.
- An incorrect conversion may have been selected. See chapter “4. Settings”.
- The selected conversion scale is not in the permissible range (“no conversion”). Select another hardness scale
- The test is conducted while the device is not held vertically on the surface, which will generally give a warning on the guidance dialog. This may occur especially when using tripod. Try using another foot, or take more care to align the probe vertically to the surface.
- Test piece is insufficiently supported. Prepare the test piece for the test e.g. through supporting it with a larger metal piece.
- Make sure the probe does not tilt / move on the surface. See chapter “3.3.1.7 Testing Curved Surfaces”.
- If the instrument still shows excessive deviations: return the device to an authorized Proceq Service Centre for recalibration / inspection.



NOTE! Do not resurface test blocks or try to use non-Proceq indenters. This will impair accuracy and may also deteriorate functionality of the Portable Rockwell.

10.1.3 UCI

The allowable tolerances for the UCI performance test differ depending on the selected standard. According to the DIN 50159 it should typically not differ more than 5% from the given value. This tolerance is getting wider for harder test blocks. The Equotip 550 considers these limits according to the standard.

According to the ASTM A1038 the values may not deviate by more than 3%, no matter what hardness is tested.

- Check to have the correct settings selected, i.e. no conversion activated.
- Clean the indenter, paying close attention especially to the front part (diamond).
- Check that the test block is clean, smooth and dry. See chapter “3.3.3.2 Sample Preparations”. Replace the test block if there is insufficient space for additional tests.
- Check the mounting and wear of the special foot. Check for deposits. Clean or replace if necessary.
- If the test was conducted while the device was not held vertically on the surface, the reading can be misleading. This may occur especially when using the standard foot. Try using the special foot, or take more care to align the probe vertically to the surface.

- Test piece is not fulfilling the geometry requirements or is insufficiently supported. Check chapter “3.3.3.4 Test Conditions” for the minimum requirement. Prepare the test piece for the test i.e. by supporting it with a larger metal piece.
- If the instrument still shows excessive deviations: Return the device to an authorized Proceq Service Centre for recalibration / inspection.



NOTE! Do not resurface test blocks.

10.2 No Reading Displayed

- Check the connection of the probe.
- Check if a genuine Equotip impact body (with the engraving “equo”) is inserted in the impact device by unscrewing the support ring.
- Check for tight seating of the support ring on the thread of the impact device.
- Check for tight seating of the support ring on the thread of the impact device. Check whether the impact body is armed and released when conducting the load – trigger procedure. If not, the catch chuck of the impact device may be broken or the impact body is inserted upside-down. Insert the impact body correctly or replace the impact device with a basic Equotip Leeb impact device.

10.3 Battery

If the indicating device does not switch on, recharge the battery using the power supply, see chapter “2.1 Installation”.

The battery can be replaced with another Equotip Lithium-Ion battery.



NOTE! If the operation time of the battery is shortening noticeably, order a new battery. The battery lifetime has expired when the LED does not go off even though the battery has been charged for several days.

Danger: Only use the power supply (12 V, 5 A) to charge the Equotip 550.

10.4 Touchscreen Calibration

In very seldom cases, or when a protective screen foil is used, it can be necessary to re-calibrate the Equotip 550.

To do so, press and hold the middle hardware button (Fullscreen) for 10s. During the calibration process, don't touch the display unit, as it can bias the calibration.

11. Equotip Link Software

11.1 Starting Equotip Link



Locate the file “Equotip Link Setup.exe” on your computer or on the DVD and click on it. Follow the instructions on the screen. Make sure that the “Launch USB Driver install” tick is selected.

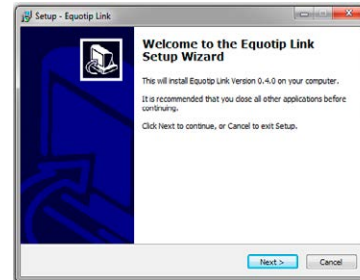

Double click on the Equotip Link Icon on your desktop or start the program via the start menu.

11.2 Application Settings

The menu item “File – Application settings” allows the user to select the language and the date and time format to be used.

11.5.1 Adjusting Date and Time

Right click in the “Date & Time” column.

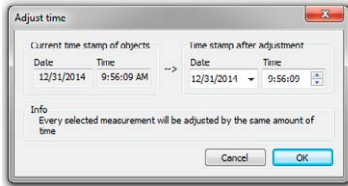

The time will be adjusted for the selected series only.

11.6 Exporting Data

Equotip Link allows you to export selected objects or the entire project. To use the data for further analysis in a third party program, such as e.g. Microsoft Excel, it can be exported as a comma separated file (CSV). To use it directly in a report, the series data can be exported as a graphic. As a third option, selected series data can be printed out directly on a printer.

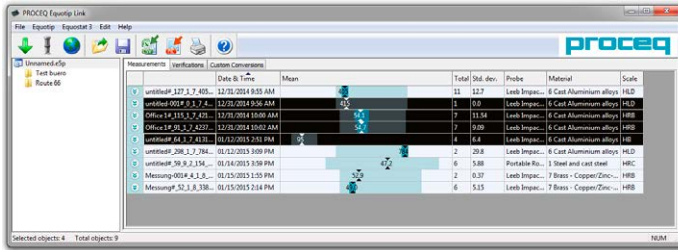

Click on the “Export as CSV file(s)” icon. The data is then exported as a Microsoft Office Excel comma separated file. The export options may be chosen in the following window:



Click on the “Export as graphic” icon to open the following window which allows the various export options to be chosen.



Click on the printer icon to directly print a report of the selected measurement series.

11.7 Exporting and Importing of Setting Profiles

To transfer all the selected settings from one instrument to another, or to back up, click on “Equotip – Download device application settings”. The actual settings will be stored in the specified folder on the PC as an archive.

To re-install stored settings, click on “Equotip – Upload device application settings”.

11.8 Exporting and Importing of Conversion Curves

Custom conversion curves created on the instrument can be downloaded to the PC by clicking on “Equotip - Download customer conversion”. All available customer conversions from the instrument will be stored on the PC in the folder ...\\Proceq\\EquotipLink\\Conversions.

To upload a conversion curve from your PC, choose “Equotip - Upload customer conversions”. This is also possible for existing Equotip3 conversion curves.

12. Technical Specifications

12.1 Instrument

Display	7" color display 800x480 pixels
Memory	Internal 8 GB Flash memory (up to 1'000'000 measurements)
Regional settings	Metric and Imperial units, multi-language and timezone supported
Battery	Lithium Polymer, 3.6 V, 14.0 Ah
Battery lifetime	> 8h (in standard operating mode)
Power input	12 V +/-25 % / 1.5 A
Weight (of display device)	About 1525 g (incl. Battery)
Dimensions	250 x 162 x 62 mm
Max. altitude	2'500 m above sea level
Humidity	< 95 % RH, non condensing
Operating temperature	0 to 30°C (32 to 86°F) (Charging, running instrument) 0 to 40°C (32 to 104°F) (Charging, instrument is off) -10 to 50°C (14 to 122°F) (Non-charging)
Environment	Suitable for indoor & outdoor use
IP classification	IP 54
Pollution degree	2
Installation category	2



NOTE! Charging equipment is for indoor use only (no IP classification).

12.2 Power Supply

Model	HK-AH-120A500-DH
Input	100-240 V / 1.6 A / 50/60 Hz
Output	12 V DC / 5 A
Max. altitude	2500 m above sea level
Humidity	< 95%
Operating temperature	0 - 40°C (32 to 104°F)
Environment	Indoor use only
Pollution degree	2
Installation category	2

12.3 Equotip Leeb Impact Devices

Measuring range	1-999 HL
Measuring accuracy	± 4 HL (0.5 % at 800 HL) ± 6 HLU (for Leeb U)
Resolution	1 HL; 1 HV; 1 HB; 0.1 HRA; 0.1 HRB; 0.1 HRC; 0.1 HS; 1 MPa (N/mm ²)
Impact direction	Automatic compensation (excl. DL/U probe)
Impact energy	<ul style="list-style-type: none">• 11.5 Nmm for D, DC, E, S probes• 11.1 Nmm for DL probe• 3.0 Nmm for C probe• 90.0 Nmm for G probe• 200.0 Nmm for U probe
Mass of impact body	<ul style="list-style-type: none">• 5.45 g (0.2 ounces) for D, DC, E, S probes• 7.25 g (0.26 ounces) for DL probe• 3.10 g (0.11 ounces) for C probe• 20.0 g (0.71 ounces) for G probe• 26.0 g (0.92 ounces) for U probe
Ball indenter	<ul style="list-style-type: none">• Tungsten carbide, 3.0 mm (0.12") diameter for C, D, DC probes• Tungsten carbide, 2.78 mm (0.11") diameter for DL probe• Tungsten carbide, 5.0 mm (0.2") diameter for G probe• Ceramics, 3.0 mm (0.12") diameter for S probe• Polycrystalline diamond, 3.0 mm (0.12") diameter for E probe• Hardened Steel, 50.0 mm (1.97") diameter for U probe
Operating temperature	-10 to 50°C (14 to 122°F)

12.4 Equotip Portable Rockwell Probe

Dimensions	112 x \varnothing 40 mm (4.4 x \varnothing 1.57 inches without foot)
Weight	260 g (9.17 oz)
Power supply	Via USB (5 V, max. 100 mA)
Measuring range	0-100 μ m; 19-70 HRC; 34-1080 HV
Measuring accuracy	1.5 HRC according to DIN 50157
Resolution	0.1 μ m; 0.1 HRC; 1 HV
Test direction	Any direction (no correction required)
Test loads	10 N / 50 N (probe 50 N)
Diamond indenter	Angle 100.0° \pm 0.5°
Operating temperature	0 to 50°C (32 to 122 °F)
Humidity	Non-condensing, 90% max.

12.5 Equotip UCI Probe

Dimensions	155 x \varnothing 40 mm (6.1 x \varnothing 1.57 inches) without foot
Weight	270 g (9.52 oz)
Power Supply	via Proceq Interface
Measuring Range	20 – 2000 HV
Measuring accuracy	\pm 2 % (150 – 950 HV)
Resolution	1 HV; 0.1 HRC
Test direction	Any direction (no correction required)
Trigger loads	Selectable: HV1 (~10N), HV2 (~20N), HV3 (~30N), HV4 (~40N), HV5 (~50N)
Diamond indenter	Vickers diamond according to ISO 6507-2
Operating temperature	0 to 50°C (32 to 122°F)
Humidity	Non-condensing, 90% max.

13. Standards & Guidelines

- ISO EN 16859
- ISO 18265
- DIN 50156 / 50157 / 50159
- ASTM A956 / E140 / A370 / A1038
- DGZfP Guideline MC 1
- VDI / VDE Guideline 2616 Paper 1
- Nordtest Technical Report Series 424, Reports 99.12 / 99.13 / 99.36
- ASME CRTD-91
- GB/T 17394
- JB/T 9378
- JJG 747
- JIS B7731

14. Ordering Information

14.1 Units

Part No.	Description
356 10 001	Equotip 550 consisting of Equotip Touchscreen incl. Battery, Power Supply, USB-Cable, Surface Roughness Comparator Plate, DVD with Software, Documentation, Carrying Strap and Carrying Case
356 10 002	Equotip 550 Leeb D consisting of Equotip Touchscreen incl. Battery, Equotip Basic Leeb Impact Device D, Impact Body D, Support Rings (D6,D6a), Cleaning Brush, Impact Device Cable, Test Block ~775 HLD / ~56 HRC, Coupling Paste, Power Supply, USB-Cable, Surface Roughness Comparator Plate, DVD with Software, Documentation, Carrying Strap and Carrying Case
356 10 003	Equotip 550 Leeb G consisting of Equotip Touchscreen incl. Battery, Equotip Basic Leeb Impact Device G, Impact Body G, Support Rings (G6,G6a), Cleaning Brush, Impact Device Cable, Test Block ~570 HLG / ~340 HB, Coupling Paste, Power Supply, USB-Cable, Surface Roughness Comparator Plate, DVD with Software, Documentation, Carrying Strap and Carrying Case
356 10 004	Equotip 550 Portable Rockwell consisting of Equotip Touchscreen incl. Battery, Equotip Portable Rockwell Probe 50 N, Protective Rubber Sleeve, Probe Cable, Test Block ~62HRC, Power Supply, USB-Cable, Surface Roughness Comparator Plate, DVD with Software, Documentation, Carrying Strap and Carrying Case

356 10 005	Equotip 550 UCI consisting of Equotip Touchscreen incl. Battery, Equotip UCI Probe HV1-HV5, UCI Probe Cable, UCI Test Block ~850 HV, Power Supply, USB-Cable, Surface Roughness Comparator Plate, DVD with Software, Documentation, Carrying Strap and Carrying Case
356 10 006	Equotip 550 Leeb U (for paper, film and foils) consisting of Equotip Touchscreen incl. Battery, Equotip Leeb Impact Device U, Cleaning Brush, Probe Cable, Power Supply, USB-Cable, DVD with Software, Documentation, Carrying Strap and Carrying Case
356 10 020	Equotip 550 Portable Rockwell & UCI Kit consisting of Equotip 550 UCI (356 10 005) and Equotip Portable Rockwell Probe 50 N (356 00 600)
356 10 021	Equotip 550 Portable Rockwell & Leeb D Kit consisting of Equotip 550 Leeb D (356 10 002) and Equotip Portable Rockwell Probe 50 N (356 00 600)
356 10 022	Equotip 550 Leeb D & UCI Kit consisting of Equotip 550 Leeb D (356 10 002), Equotip UCI Probe HV1-HV5 (356 00 700) and Equotip UCI Test Block ~850 HV, ISO 6507-3 HV5 Calibration (357 54 100)

14.2 Impact Devices & Probes

Part No.	Description
	Impact Device incl. Support Ring, Impact Body, Cable
356 00 500	Equotip Leeb Impact Device C
356 00 100	Equotip Leeb Impact Device D
356 00 110	Equotip Leeb Impact Device DC

356 00 120	Equotip Leeb Impact Device DL
356 00 400	Equotip Leeb Impact Device E
356 00 300	Equotip Leeb Impact Device G
356 00 200	Equotip Leeb Impact Device S
360 04 600	Equotip Leeb Impact Device U
	Impact Device only
353 00 501	Equotip Basic Leeb Impact Device C
353 00 101	Equotip Basic Leeb Impact Device D
353 00 111	Equotip Basic Leeb Impact Device DC
353 00 121	Equotip Basic Leeb Impact Device DL
353 00 401	Equotip Basic Leeb Impact Device E
353 00 301	Equotip Basic Leeb Impact Device G
353 00 201	Equotip Basic Leeb Impact Device S
360 04 032	Equotip Basic Leeb Impact Device U
356 00 600	Equotip Portable Rockwell Probe 50N (for Equotip 550 or PC)
356 00 700	Equotip UCI Probe HV1-HV5

14.3 Parts and Accessories

Part No.	Description
327 01 043	Carrying Strap complete
327 01 033	Battery complete

351 90 018	USB-Cable 1.8 m (6 ft)
327 01 061	Power Supply
711 10 013	Power Supply Cable USA 0.5 m (1.7 ft)
711 10 014	Power Supply Cable UK 0.5 m (1.7 ft)
711 10 015	Power Supply Cable EU 0.5 m (1.7 ft)
327 01 053	Quick Charger
356 00 081	Equotip Surface Roughness Plate
350 01 015	Equotip Coupling Paste
356 00 082	Display Antiglare Protection Film for Touchscreen Unit
356 00 080	Equotip Leeb Impact Device Cable 1.5 m (5 ft)
353 00 086	Equotip Leeb Impact Device Extension Cable 5 m (15 ft)
356 00 083	Equotip Leeb Impact Device U Cable 1.5 m (5 ft)
350 01 004	Equotip Impact Body D/DC
350 71 311	Equotip Impact Body DL
350 71 413	Equotip Impact Body S
350 08 002	Equotip Impact Body G
350 07 002	Equotip Impact Body E
350 05 003	Equotip Impact Body C
360 04 504	Equotip Impact Body U
350 01 009	Equotip Support Ring D6
350 01 010	Equotip Support Ring D6a
350 08 004	Equotip Support Ring G6

350 08 005	Equotip Support Ring G6a
350 71 314	Equotip Support Ring DL
360 04 531	Equotip Support Ring U
353 03 000	Set of Support Rings (12pcs) for Equotip Leeb Impact Device D/DC/C/E/S
350 01 008	Equotip Leeb Impact Device Cleaning Brush D/DC/C/E/S
350 08 006	Equotip Leeb Impact Device Cleaning Brush G
360 04 502	Equotip Leeb Impact Device Cleaning Brush U
350 01 007	Equotip Leeb Impact Device DC Loading Stick
350 71 316	Equotip Leeb Impact Device DL Plexiglas Sleeve
360 04 530	Assembly Gauge for Equotip Leeb Impact Device U
354 01 139	Equotip Portable Rockwell Probe Cable 2 m (6 ft)
354 01 200	Equotip Portable Rockwell Measuring Clamp
354 01 130	Equotip Portable Rockwell Tripod
354 01 250	Equotip Portable Rockwell Special Foot RZ 18 - 70
354 01 253	Equotip Portable Rockwell Special Foot RZ 70 - ∞
354 01 137	Equotip Portable Rockwell Protective Rubber Sleeve
354 01 243	Equotip Portable Rockwell support Z2 for measuring clamp
354 01 229	Equotip Portable Rockwell Support Z4+28 for measuring clamp (for tubes and pipes over Ø 28 mm)

Proceq Europe

Ringstrasse 2
CH-8603 Schwerzenbach
Phone +41-43-355 38 00
Fax +41-43-355 38 12
info-europe@proceq.com

Proceq UK Ltd.

Bedford i-lab, Priory Business Park
Stannard Way
Bedford MK44 3RZ
United Kingdom
Phone +44-12-3483-4515
info-uk@proceq.com

Proceq USA, Inc.

117 Corporation Drive
Aliquippa, PA 15001
Phone +1-724-512-0330
Fax +1-724-512-0331
info-usa@proceq.com

Proceq Asia Pte Ltd

12 New Industrial Road
#02-02A Morningstar Centre
Singapore 536202
Phone +65-6382-3966
Fax +65-6382-3307
info-asia@proceq.com

Proceq Rus LLC

Ul. Optikov 4
korp. 2, lit. A, Office 410
197374 St. Petersburg
Russia
Phone/Fax + 7 812 448 35 00
info-russia@proceq.com

Proceq Middle East

P. O. Box 8365, SAIF Zone,
Sharjah, United Arab Emirates
Phone +971-6-557-8505
Fax +971-6-557-8606
info-middleeast@proceq.com

Proceq SAO Ltd.

South American Operations
Rua Paes Leme, 136, cj 610
Pinheiros, São Paulo
Brasil Cep. 05424-010
Phone +55 11 3083 38 89
info-southamerica@proceq.com

Proceq China

Unit B, 19th Floor
Five Continent International Mansion, No. 807
Zhao Jia Bang Road
Shanghai 200032
Phone +86 21-63177479
Fax +86 21 63175015
info-china@proceq.com

Subject to change. Copyright © 2016 by Proceq SA, Schwerzenbach. All rights reserved.
82035601E ver 02 2016

The Proceq logo consists of the word "proceq" in a bold, lowercase, sans-serif font. The letters are a vibrant blue color. The 'p' and 'c' are connected, and the 'e' and 'q' are also connected. The overall style is modern and professional.