



Sauter GmbH

Ziegelei 1
D-72336 Balingen
E-Mail: info@kern-sohn.com

Tel.: +49-[0]7433- 9933-0
Fax: +49-[0]7433-9933-149
Internet: www.sauter.eu

Instruction Manual Digital Force Gauge

SAUTER FL

V. 1.3
01/2015
GB



PROFESSIONAL MEASURING

FL-BA-e-1513



SAUTER FL

V. 1.3 01/2015

Instruction Manual Digital Force Gauge

Summarize:

1	Introduction.....	3
2	Before Use.....	3
3	Operation Overview.....	3
4	Battery Indicator.....	3
5	Fitting Accessories.....	3
6	Mounting to a Fixture or Test Stand.....	4
7	Powering on.....	4
8	Basic Functions.....	5
9	Main Menu.....	8
10	Measurement Practice.....	12
11	Detailed technical description of FL.....	12
11.1	Output / Output rating / Hardware adjustments.....	12
11.2	RS 232 interface occupancy.....	13
12	Adjustment procedure.....	13
13	Declaration of Conformity.....	16

1 Introduction

Thank you for choosing the SAUTER FL series instrument. With correct use and regular re-calibration it will give many years of accurate and reliable service.

The FL can measure tensile and compressive forces accurately, being simply used by the operator. It may be used handheld or mounted on a fixture or test stand.

SAUTER offers software and accessories to make the force gauge even more versatile. Ask your SAUTER distributor for additional information or visit our website at www.sauter.eu

2 Before Use

After having received the unit please check that no physical damage has occurred to the packaging material, plastic case or the instrument itself. If any damage is evident, please notify SAUTER immediately.

3 Operation Overview

The most common used features (such as displaying force, peak hold, zero and changing of displayed units) can all be done by pressing a single dedicated key identified on the front panel-see the *Basic Functions* section.

You can press a menu key to access the gauge configuration- see the *Main Menu* section.

The FL is supplied with a set of 4 Nickel Metal Hydride AA rechargeable batteries. For safety reasons during transportation the batteries are shipped discharged. To obtain maximum battery life we recommend that you charge them with the charger/adaptor supplied for at least 14-16 hours when you first receive the instrument.

4 Battery Indicator

- battery supply > 4.8 V
- ▣ 4.8 V > battery supply > 4.7 V
- ▣ 4.7 V > battery supply > 4.4 V
- ▣ 4.4 V > battery supply > 4.0 V
- battery supply < 4.0 V

If battery level is less than 3.9 V, The “battery empty” message will be displayed and the gauge will power down automatically.

5 Fitting Accessories

Couple fittings directly to the load cell stem or use an extension rod. The threads are M6 and have capacities up to 2500 N.

Ensure that the fixing does not contact the force gauge case. Ensure that anything coupled to the gauge is screwed finger-tight only. Excessive torque can damage the load cell and is not covered by warranty.

6 Mounting to a Fixture or Test Stand

The four M3 thread holes on the rear of the gauge can be used for mounting the gauge to a SAUTER test stand. 4xM3 screws are included in delivery.

Backside housing and dimensions of the force gauge:

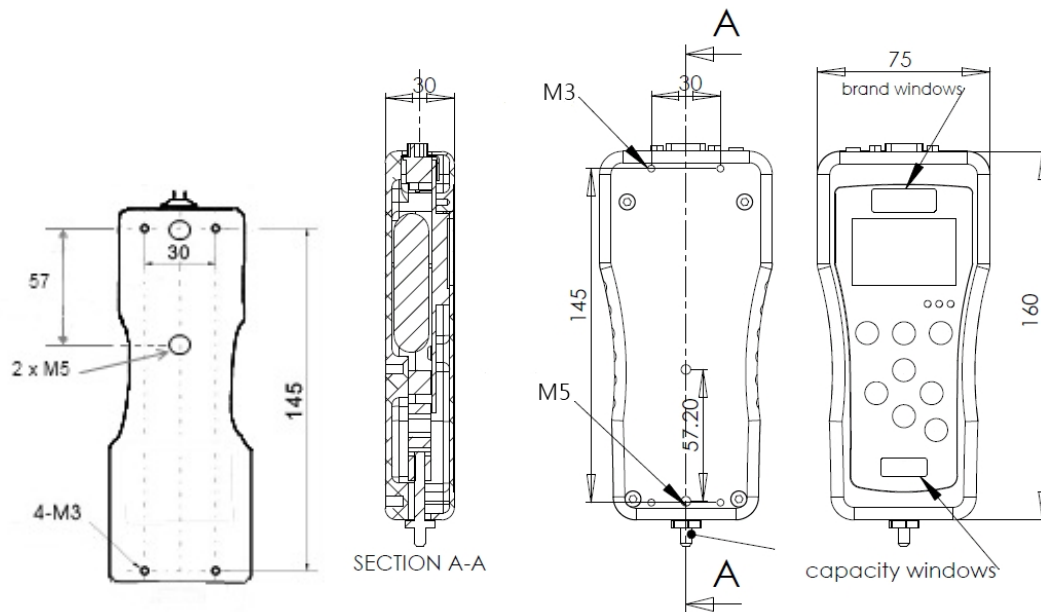

7 Powering on

As shown in Figure 1 the control panel has eight keys.

Figure 1



To power up the gauge, the ON/OFF key has to be pressed. A short self-test will start during which the capacity in Newton will be shown.

After the self test, providing no load has been applied to the instrument, the display will show all zeroes. This is because the gauge re-zeroes itself during the self-test routine.

**If a force is applied via the load cell sensor (hole at the bottom of the FL), the reading on display will register the applied force.*

**Forces may not show zero if it is moved during the self test routine. Once it is properly mounted and zeroed, the reading will be stable.*

***Do not overload** the load sensor. This will cause irreparable damage. Forces greater than 120% of full-scale will produce an audible beep and OL symbol will blink on the display until load is release and RESET key is pressed.

To power down the gauge press the ON/OFF key.

**All the current settings are saved when the gauge is turned off and the gauge will function in the same mode when powered up again.*

8 Basic Functions

Tensile forces are displayed on the FL and recognized by the symbol. Compressive forces are displayed on the FL and recognized by the symbol.

Display of Tension/Compression

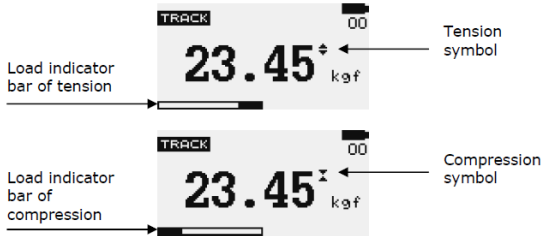

Figure 2 Tension and compression displays

A load indicator bar alerts the operator to how much load has been applied to the load sensor.

For tensile force the indicator bar is moving from right to left. For compressive forces the indicator bar is moving from left to right.

Zeroing the gauge

During the operation of the gauge it is often necessary to zero the display – e.g. when you wish to tare out the weight of a grip, so it does not become part of the measured reading. Press and release the ZERO key.

Reversible display

The display can be turned for 180°. The following has to be performed:
When the gauge is turned off, the button “Menu/Esc” has to be pressed and held. In addition, the button “On/Off” has to be pressed and the gauge will turn on and like this, the display reversion has been performed.

Changing the unit of measurement

You can choose the following units of measurement depending on the capacity of your gauge:

milliNewton, kiloNewton, Newton, gram-force, kilogram-force, ounce force or pound-force.

To change the display units, press the UNIT key. Each successive key pressed will select the next available units until the gauge returns to its original setting. The FL automatically converts readings as a new unit of measurement is selected.

**Note: All units may not be displayed depending on the capacity of the gauge.*

Changing the mode of measurement

You can choose the following modes of measurement:

Track, Peak-Tension, and Peak-Compression, to change the display mode press MODE key. Each successive key pressed will select the next available modes until the gauge returns to its original setting.

Track mode

Press MODE key until the appeared on the display. The display will now indicate forces applied in both directions as they are applied to the load sensor and maintain the live display. See Figure 3a



Figure 3a Track

Peak-Tension mode

Press MODE key until the **PEAK** symbol appears on the display. The display will show the maximum tensile force. See Figure 3b

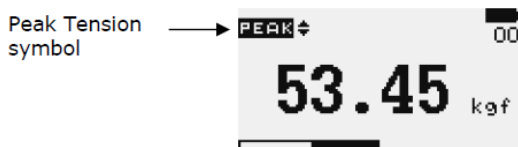

Figure 3b Peak Tension

Peak-Compression mode

Press MODES key until **PEAK** symbol appears on the display. The display will show the maximum compressive force. See Figure 3c



Figure 3c Peak Compression

RESET the gauge

Press RESET key to clear both maximum registers and prepare for detecting the next maximum readings.

Backlight Display

If any key is pressed or forces are applied to the load sensor bigger than 0.5 % of full scale, the backlight will be activated for 60 seconds.

Saved reading to memory

Any reading can be saved anytime by pressing MEM/ENTER key. A total of 500 readings can be stored in the database included the reading unit.

Computer Control of Force Gauge

A computer can control the force gauge by sending RS-232 commands.

RS-232 Command	Action
"m"	Changing measure mode.
"u"	Changing measure unit.
"z"	Zero the gauge.
"r"	Reset the gauge.

RS232 output signal

The displayed reading of the FL may be transmitted to a PC by pressing the PRINT key or sending request command from PC to the force gauge.

RS232 command	Action
"l"	Send live reading value with unit.
"p"	Send peak tension value with unit.
"c"	Send peak compression value with unit.
"x" or pressing PRINT key	Send live reading value with unit, if current mode is track mode. Send peak tension value with unit, If current mode is peak tension mode. Send peak compression value with unit. If current mode is peak compression mode.
"d"	Send memory
"!"	Send information of gauge (model, capacity, serial number, firmware revision, original offset, current offset, overload count).

9 Main Menu

Press MENU/ESC key to access the main menu. To move between the option listed on the main menu page, press UP and DOWN arrow keys to move the cursor. Press ENTER to select the sub-menus, activate feature and enter values. Within sub-menus UP, DOWN, LEFT and RIGHT arrow keys will also change numerical values. Press ESC to return to the main menu page.

Figure 4

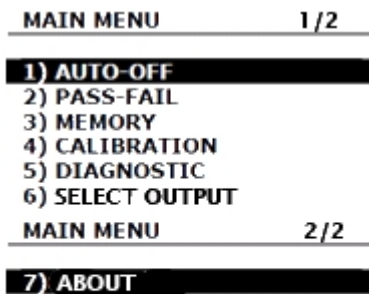

1) AUTO-OFF

Press the MENU key, the display will show the main menu page and use UP and DOWN to move the cursor point to *AUTO-OFF*.

Press the ENTER key. The display will show the Auto-off menu page.

Press ESC key to return to the main menu page.

An Auto-off feature can be enabled to conserve battery power where the gauge powers down after 5,10 and 15 minutes (depending on Auto-off time) since the last key has been pressed. The AO will appear in the main display if you activate this feature.

Figure 5

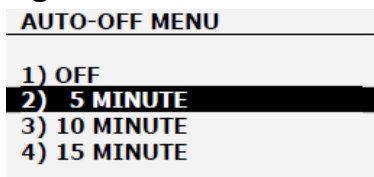

Use UP and DOWN key to move the cursor. Press the ENTER key to select auto-off option and return to main menu page.

2) PASS-FAIL

The Pass-Fail feature used to set a defined acceptable maximum and minimum forces gap for measuring. It is activated by setting the lower level and upper level forces limit. If the forces value is within the gap level, the display will show message

PASS. Any reading values outside this gap (higher or lower), the display will show message *FAIL*. If you activate this feature the *PF* symbol will be shown on main display.

To access *PASS-FAIL* menu, Press UP and DOWN to move the cursor point to *PASS-FAIL* and press the ENTER key the display will show the Pass-Fail menu page. Press ESC key to return to the main menu page.

Figure 6

PASS FAIL MENU		
UPPER =	<u> 2.5 </u>	N
LOWER =	1.0	N
Press 'Zero' key to Clear both value.		

Use LEFT ARROW keys to move the cursor point to *the desired value*.

Use UP and DOWN keys to change the value, press and hold to scroll values. Use RIGHT ARROW key to change the unit. Press ENTER to save the settings and return to main menu page.

**Pass-Fail feature will automatically be disabled if you set LOWER and UPPER = 0 N.*

**LOWER must be less than the UPPER.*

Example LOWER LEVEL = 0 N, UPPER LEVEL = 20 N

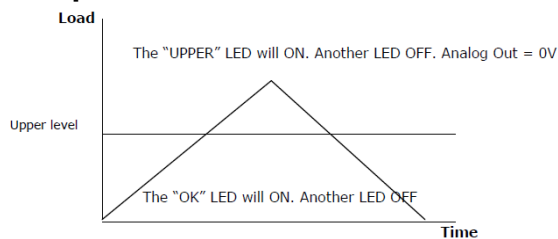

Figure 6a

Example LOWER LEVEL = 10 N, UPPER LEVEL = 20 N

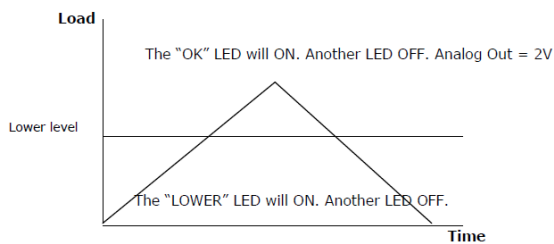

Figure 6b

Example LOWER LEVEL = 10 N, UPPER LEVEL = 20 N

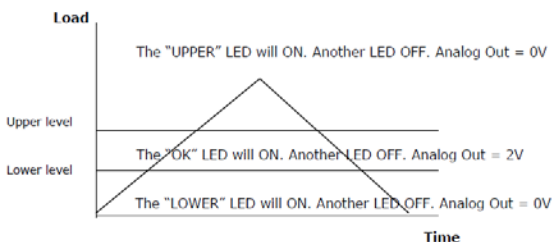

Figure 6c

3) MEMORY

This is used to view the saved record, delete current record, delete all record and print data of the saved record.

To access *MEMORY* menu, go to the main menu page press UP and DOWN to move the cursor point to *MEMORY* and press ENTER key the display will show the memory page. Press ESC key to return to main menu page.



Figure 7a Memory Page

Press UP and DOWN to change memory page, press and hold to scroll change memory page. Press PRINT key to print the memory to the serial port. Press ZERO key to access the *DELETE* menu.

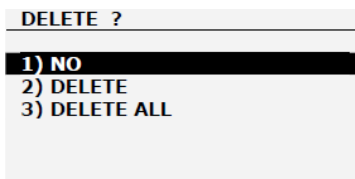

Figure 7b Delete last Menu

Press UP and DOWN to select the delete option. If you selected *NO* and press ENTER key, the gauge will return to memory page. If you selected *DELETE* and press ENTER key the gauge will delete current saved record and return to memory page. If you selected *DELETE ALL* and press ENTER key the gauge will delete all saved record and return to memory page.

4) ADJUSTMENT

The instrument should be adjusted by experienced staff only.

To get into the adjustment mode, you need to enter a password, which is 7780.

You can find a detailed description of this procedure in chapter 12 at the end of this instruction manual. Take care that you need weights to adjust the force gauge. For more details, please contact your SAUTER distributor or SAUTER GmbH directly per phone (number mentioned above) or by e-mail.

5) DIAGNOSTIC

This is used to check status of the load cell. If you suspect that your load cell transducer has sustained an overload it is possible to check the status of the load cell immediately.

Place the gauge horizontally on the flat level surface and go to main menu page. Use UP and DOWN key to move the cursor point to *DIAGNOSTIC* and press ENTER key the display will show Diagnostic menu page. Press ESC to return to main menu page.

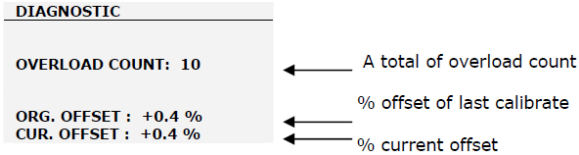

Figure 8 Diagnostic Menu

If the % offset is between 5% - 10 % please contact your supplier to arrange a recalibration of your gauge.

If the % offset is greater than 10% please contact your supplier to arrange for load cell replacement.

These values are given as an indicator only – the need for calibration / repair may vary according to the individual characteristics of the load cell.

6) SELECT OUTPUT

In this menu you can choose the output port between USB or RS232

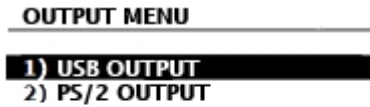

The FL-series have an analog output +/- 2V, In normal operation use analog value depend on the reading value of TRACK, PEAKT and PEAKC mode. If PASS-FAIL function is used analog value = 2V when PASS, and analog value = 0V when FAIL.

7) ABOUT This shows the information of your gauge (Firmware revision, Model, Capacity, Serial number). To access *ABOUT* menu, go to main menu page and press

UP and DOWN to move the cursor point to *ABOUT* and press ENTER key the display will show About menu page. Press ESC key to return to main menu page.

```
ABOUT
-----
FIRMWARE REV. : 1.00
MODEL:         DFS
CAPACITY:      100 N

S/N: 05130001
```

Figure 9 About Menu

10 Measurement Practice

For best measurement accuracy keep the compression/tension forces in line with the force gauge. Alleviate bending loads and torque loads applied to the load cell as these can adversely affect measurement performance.

Always keep the gauge below the capacity limit shown on the front of the gauge. If gauge is used above this capacity in either tension or compression, even for a short time, permanent load cell damage can result. Overload damage is not covered by warranty.

11 Detailed technical description of FL

Accuracy: ± 0.2 % of rated capacity

Operating temperature: 60 °F - 95 °F (15 °C - 35 °C)

Temperature shift at zero load: ± 0.04 % of full-scale/°C

11.1 Output / Output rating / Hardware adjustments

RS-232 and USB:

- 8 data bits
- 1 Start bit, 1 Stop bit
- no parity
- Baud rate: 38400
- Peak Capture Rate: 0.100 S
- ADC Sampling Rate: 1,000 Hz

11.2 RS 232 interface occupancy

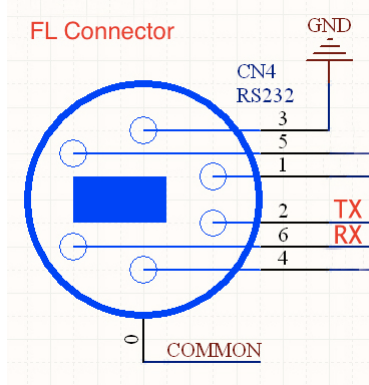

12 Adjustment procedure

Introduction

This instruction describes the calibration procedure, where a calibration password is needed to be pressed to enter certain modes of the software.

Note: Throughout this procedure, all masses used to apply a load to the load cell, should be calibrated.

Temperature Acclimatization

Inspect the instrument for damages and check all ordered requirements before placing in the calibration laboratory. Before any calibration can start, the instrument has to be acclimatized to the operating temperature of the calibration laboratory for at least two hours.

Preparation

Fit a full set of charged batteries into the gauge's battery compartment or plug in a standard GS/GTX 12V 300mA power supply.

Calibration

1. Turn the gauge on
2. Go to main menu by pressing the MENU key and press the UP and DOWN key to move the cursor to point to CALIBRATION and press ENTER key, then the *ENTER PASSWORD* page will be displayed.

**ENTER PASSWORD
4 DIGIT
PASSWORT : 0000**

Fig. 1 Enter Password Page
* *Permanent Password= 7780*

Press UP and DOWN to change the numerical, press and hold to scroll change. Press LEFT and RIGHT to change the digit, press and hold to scroll change digit.

Press ENTER key to accept your password. If your password is correct, the display will show the Calibration menu page; if not, the display will return to main menu page.

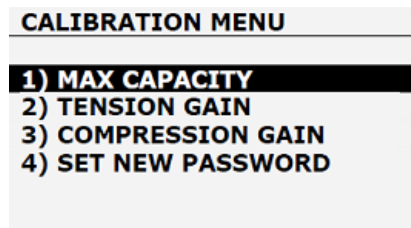

Fig. 2 Calibration Menu Page

3. Select the correct load cell capacity for the gauge. To set load capacity, press UP and DOWN key to move the cursor to point to *MAX CAPACITY* and press ENTER key. Max capacity menu page will be displayed.

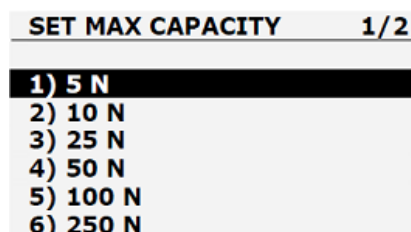

Fig. 3 Max Capacity Menu page 1

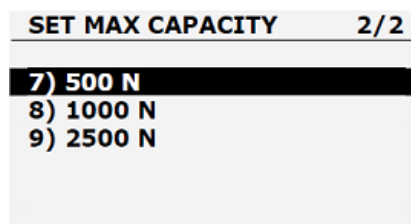

Fig. 4 Max Capacity Menu page 2

Press UP and DOWN to change max capacity, press and hold to scroll change. Press ENTER key to save selected and return to Calibration Menu page.

4) Tension Calibration. At the Calibration menu page, press UP and DOWN key to move the cursor to point to *TENSION GAIN* and press ENTER key. Tension gain menu page will be displayed:

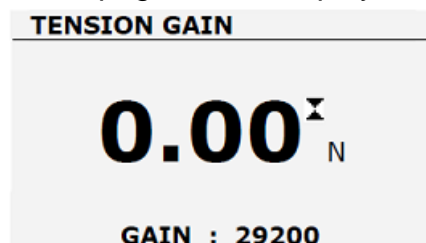

Fig. 5 Tension Gain Menu page

4.1) Tension Zero

- Set the gauge up with the necessary supports to carry out tension calibration
- Pre-stress the load cell to 100% of the instrument's capacity.

- Remove the masses but retain the supports.
- When the counts have settled, press ZERO key to store the zero counts

4.2) Tension Maximum

- Apply 100% of the instrument's capacity load onto the support(s) for tension.
- Press UP, DOWN, RIGHT ARROW or LEFT ARROW key to adjust tension gain until the gauge displayed max capacity count.
- Press ENTER key to store the counts for full-scale tension.

5.) Compression Calibration. At Calibration menu page, press UP and DOWN key to move the cursor point to *COMPRESSION GAIN* and press ENTER key. The display will show compression gain menu page.



Fig. 6 Compression Gain Menu page

5.1) Compression Zero

- Set the gauge up with the necessary supports to carry out compression calibration.
- Pre-stress the load cell to 100% of the instrument's capacity.
- Remove the masses but retain the supports.
- When the counts have settled, press ZERO key to store the zero counts

5.2) Compression Maximum

- Apply 100% of the instrument's capacity load onto the support(s) for compression.
- Press UP, DOWN, RIGHT ARROW or LEFT ARROW key to adjust compression gain until the gauge displayed max capacity count.
- Press ENTER key to store the counts for full-scale compression

6) After your successful calibration, remove any accessories which have been mounted to the gauge and place the gauge on its back on a level surface. Go to *TENSION GAIN* menu page, press ZERO key to store the original Offset, Date and Time of calibration and clear the Overload Counter.

13 Declaration of Conformity



SAUTER

Sauter GmbH
Ziegelei 1
D-72336 Balingen
E-Mail: info@sauter.eu

Ziegelei 1
D-72336 Balingen
E-Mail: info@sauter.eu

Konformitätserklärung

Deklaracja zgodności dla urządzenia ze znakiem CE
Konformitätserklärung für Geräte mit CE-Zeichen
Déclaration de conformité pour appareils portant la marque CE
Declaración de conformidad para aparatos con marca CE
Dichiarazione di conformità per apparecchi contrassegnati con la marcatura CE

D	Konformitäts- erklärung	Wir erklären hiermit, dass das Produkt, auf das sich diese Erklärung bezieht, mit den nachstehenden Normen übereinstimmt.
GB	Declaration of conformity	We hereby declare that the product to which this declaration refers conforms with the following standards.
E	Declaración de conformidad	Manifetamos en la presente que el producto al que se refiere esta declaración está de acuerdo con las normas siguientes
F	Déclaration de conformité	Nous déclarons avec cela responsabilité que le produit, auquel se rapporte la présente déclaration, est conforme aux normes citées ci-après.
I	Dichiarazione di conformità	Dichiariamo con ciò che il prodotto al quale la presente dichiarazione si riferisce è conforme alle norme di seguito citate.

Digital Force Gauge: FL

EMV-Guideline	Normatives
89/336EEC EMC 2004/108/EG	EN 61326: 1997+A1:1998+A2:2001+A3:2003

Date 25.02.2014

Signature

Place of issue 72336 Balingen

Albert Sauter
SAUTER GmbH
Manager

SAUTER GmbH, Ziegelei 1, D-72336 Balingen, Tel. +49-[0]7433/9933-199
Fax +49-[0]7433/9933-149, E-Mail: info@sauter.eu, Internet: www.sauter.eu