

Instruction Manual

HI 8043

Portable Dissolved Oxygen Meter

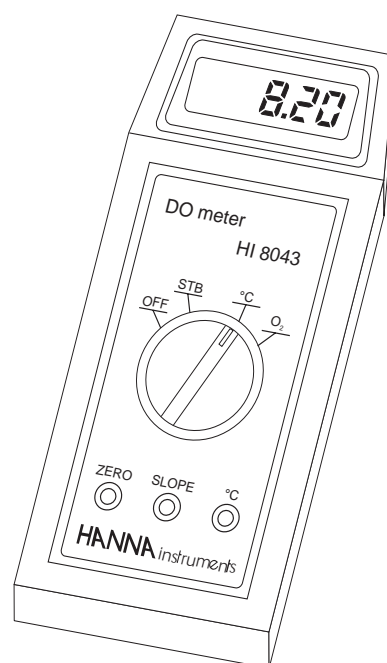

Dear Customer,
 Thank you for choosing a Hanna Instruments Product.
 Please read this instruction manual carefully before using the instrument.
 This manual will provide you with all the necessary information for the correct use of the instrument.
 If you need additional technical information, do not hesitate to e-mail us at tech@hannainst.com
 This instrument is in compliance with the CE directives.

TABLE OF CONTENTS

Preliminary Examination 3
 General Description 3
 Functional Description (Probe) 4
 Functional Description (Meter) 5
 Specifications 6
 Probe Initial Preparation 7
 Dissolved Oxygen Calibration 9
 Temperature Calibration 15
 Taking Measurements 16
 Probe & Membrane Maintenance 17
 Battery Replacement 19
 Accessories 20
 Warranty 21
 CE Declaration of Conformity 22

PRELIMINARY EXAMINATION

Remove the instrument from the packing material and examine it to make sure that no damage has occurred during shipping. If there is any damage, notify your Dealer.

Each meter is supplied complete with:

- **HI 76401** DO probe
- Spare membrane with O-ring (2 pcs)
- Protective cap
- **HI 7041S** electrolyte solution (30 mL)
- Calibration screwdriver
- 9V battery (1 pc)
- Instructions

Note: Save all packing material until you are sure that the instrument functions correctly. All defective items must be returned in the original packaging with the supplied accessories.

GENERAL DESCRIPTION

HI 8043 is a portable meter for Dissolved Oxygen measurements. It is housed in a lightweight case, with an easy-to-read LCD. Dissolved oxygen and temperature measurements can be performed in the field (wastewater treatment, fish-farming, water analysis, etc.) as well as in the laboratory without compromising accuracy. Dissolved oxygen is indicated in mg/L (ppm) and the reading is compensated for the temperature effect (ATC). The dissolved oxygen probe is provided with a membrane for covering the polarographic sensors, and features a built-in thermistor for temperature measurements and compensation.

The thin permeable membrane isolates the sensor elements from the sample, but allows oxygen to enter.

A voltage is applied across the sensor, and the oxygen that has passed through the membrane reacts causing the current to flow, hence determining a reading.

A convenient feature of the instrument is its standby mode which keeps the probe polarized and ready for instant measurements.

FUNCTIONAL DESCRIPTION (PROBE)

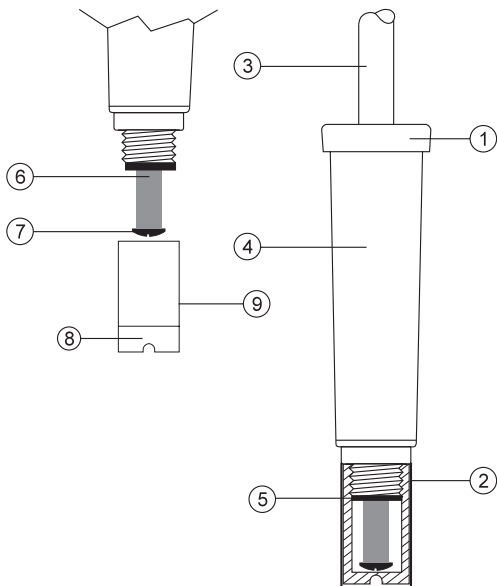

1. D.O. Probe
2. Protective Cap
3. Watertight Shielded Cable
4. Probe Body
5. O-Ring Seal
6. Silver Chloride Anode
7. Platinum Cathode (sensor)
8. Oxygen Permeable Membrane
9. Membrane Cap

FUNCTIONAL DESCRIPTION (METER)

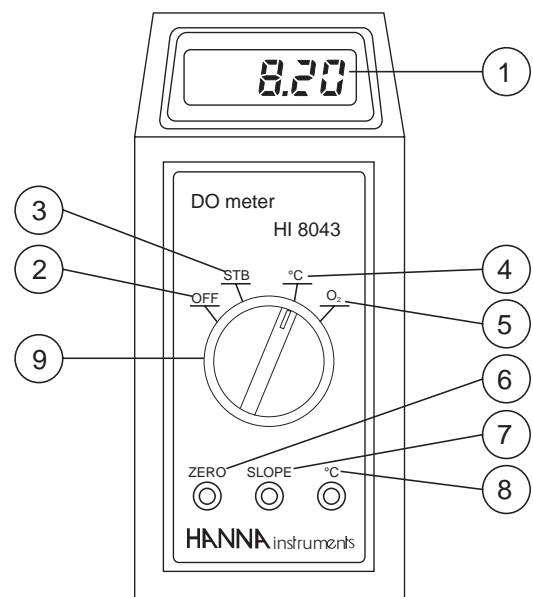

1. Liquid Crystal Display
2. "OFF" (to switch the meter off)
3. "STB" (to switch the meter on and polarize the probe. Use this standby position without switching the meter off if you are going to take further measurements)
4. "°C" Measurement
5. "O₂" Measurement
6. ZERO Calibration Trimmer
7. SLOPE Calibration Trimmer
8. °C Calibration Trimmer
9. Rotary Switch

SPECIFICATIONS

Range	0.00 to 19.99 mg/L O ₂ 0.0 to 50.0°C (32 to 122 °F)
Resolution	0.01 mg/L O ₂ 0.1°C
Accuracy	±1.5% F.S. (O ₂) ±0.5°C
Typical EMC Deviation	±1.5% F.S. (O ₂) ±1°C
Calibration	Manual, 2 point (zero and slope)
Temperature Compensation	Automatic, 0 to 30°C (32 to 86°F)
Probe	HI 76401 polarographic with 3 m (10') cable (included)
Battery Type	1 x 9V
Life	approx. 100 hours of continuous use
Environment	0 to 50°C (32 to 122°F); RH max 95%
Dimensions	180 x 83 x 40 mm (7.1 x 3.3 x 1.6")
Weight	240 g (8.4 oz.)

PROBE INITIAL PREPARATION

PROBE PREPARATION

All DO probes are shipped dry. To hydrate the probe and prepare it for use, connect it to the meter and proceed as follows.

1. Remove the red & black plastic cap. This cap is only used for protecting the probe during shipment, and can be thrown away.
2. Wet the sensor by soaking the bottom (2.5 cm/1") of the probe in **HI 7041S** electrolyte solution for 5 minutes.
3. Rinse the supplied membrane (**HI 76407A**) with some electrolyte while shaking it gently. Refill with clean electrolyte.

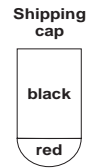

4. Gently tap the sides of the membrane with your finger tip to ensure that no air bubbles remain trapped inside. To avoid damaging the membrane, do not tap the membrane directly on the bottom.
5. Make sure that the rubber O-ring sits properly inside the membrane cap.
6. With the sensor facing down, screw the cap clockwise. Some electrolyte will overflow.

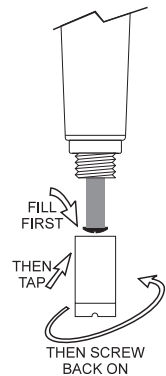

When the probe is not used, protect the membrane with the supplied cap.

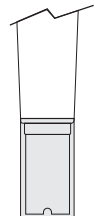

PROBE POLARIZATION

When the probe is under polarization it is continuously fed with a voltage of approximately 800 mV.

Probe polarization is essential for stable measurements to be taken with the same degree of accuracy.

With polarized probe, oxygen is continually "consumed" by passing through the sensitive diaphragm and dissolving in the electrolyte solution contained in the probe.

If this operation is interrupted, the electrolyte solution continues to be enriched with oxygen until it reaches an equilibrium with the surrounding solution.

If measurements are taken with a non-polarized probe, the oxygen level detected by the meter is the sum of the oxygen dissolved in the tested sample and that of the electrolyte solution itself.

By leaving the instrument in the "STB" mode (i.e. keeping the probe in a continual state of polarization), the oxygen of the electrolyte solution is progressively "consumed", and the following measurements detect only the quantity of oxygen dissolved in the sample to be tested.

Therefore, in order to keep the probe continuously polarized it is necessary to switch the meter to the "STB" mode and wait for at least 30 minutes. This should be done with the probe covered with the protective cap and filled with some electrolyte solution.

Polarization is not maintained when the instrument is switched OFF.

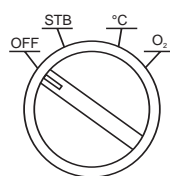
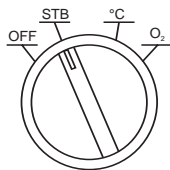

DISSOLVED OXYGEN CALIBRATION

The calibration should be verified:

- after approximately 20 hours of use
- whenever the electrolyte or membrane is changed and after cleaning the electrode
- after use in aggressive solutions.

Accessories:

- 200 cc of **HI 7040** solution
- 1 bottle of **HI 7041** solution

Calibration at sea level:

- Switch the meter ON, set the knob to the "STB" position and wait 30 minutes for a complete polarization of the probe.

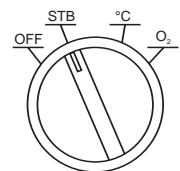

ZERO CALIBRATION

- Switch from "STB" to "O₂" position.
- Remove the membrane protective cap, immerse the probe in **HI 7040** zero oxygen solution and wait for approx. 5 minutes.

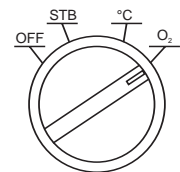

- The indications given by the instrument must fall to stabilization levels. If the probe has not been sufficiently polarized, the readout will continue to fluctuate.

In this case, switch back to "STB" position, place the protective cap and wait for a few hours for complete polarization before proceeding.

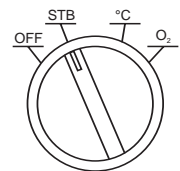

- Using a small screwdriver, turn the "Zero" calibration trimmer until the display reads zero.

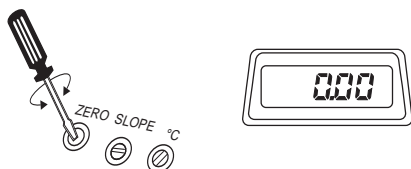

- If the zero point is passed, "1" will appear on the display. If you cannot get zero reading, the probe is probably defective. Check the membrane, electrode and electrolyte solution.

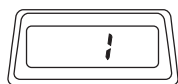

After the zero calibration has been completed, rinse the probe thoroughly with tap water.

SLOPE CALIBRATION

In order to perform a highly accurate calibration, take a B.O.D. bottle and fill with water to a depth of 1-2 cm (½ - ¾"). Seal the bottle with the probe inside.



If this calibration is carried out with the bottle opened to air rather than according to the conditions described above, the margin of error is approximately 0.1 ppm.

- Switch the instrument to "°C", wait for reading to stabilize and note the temperature of the water.
- See Table 1 on page 12 for the DO reading corresponding at the noted temperature.
- Switch to "O₂" position and adjust the "Slope" trimmer until the correct reading is displayed.

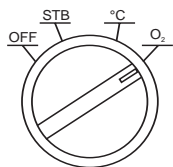
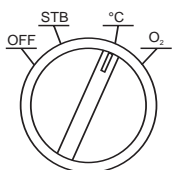

E.g. at 20.5°C the trimmer should be adjusted to read 9.08.

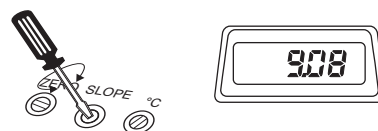

ALTITUDE COMPENSATION

If the calibration is not performed at sea level, a correction should be made for the altitude effect according to Table 2 on page 13.

E.g. at 20.5°C and at an altitude of 300 m above sea level, the "Slope" trimmer should be adjusted to read $9.08 \times 0.96 = 8.72$.

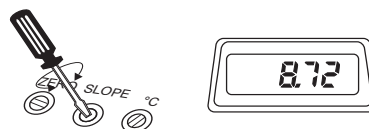

SALINITY COMPENSATION

An additional correction has to be performed if the sample presents significant salinity concentrations. In such case, the reading has to be adjusted according to Table 3 on page 14. E.g. at 20.5°C and if the sample has a salinity content of 3 g/L, the "Slope" trimmer should be adjusted to read $9.08 - (3 \times 0.0478) = 8.94$.

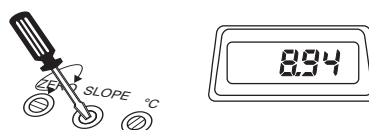

Table 1
Dissolved Oxygen (ppm) in Fresh Water
as a function of Temperature (°C)

°C	0.0	0.1	0.2	0.3	0.4	0.5	0.6	0.7	0.8	0.9
0	14.62	14.58	14.54	14.50	14.46	14.43	14.39	14.35	14.31	14.27
1	14.23	14.19	14.15	14.11	14.07	14.03	14.00	13.96	13.92	13.88
2	13.84	13.80	13.77	13.73	13.70	13.66	13.62	13.59	13.55	13.52
3	13.48	13.45	13.41	13.38	13.34	13.31	13.27	13.24	13.20	13.17
4	13.13	13.10	13.06	13.03	13.00	12.97	12.93	12.90	12.87	12.83
5	12.80	12.77	12.74	12.70	12.67	12.64	12.61	12.58	12.54	12.51
6	12.48	12.45	12.42	12.39	12.36	12.33	12.29	12.26	12.23	12.20
7	12.17	12.14	12.11	12.08	12.05	12.02	11.99	11.96	11.93	11.90
8	11.87	11.84	11.81	11.79	11.76	11.73	11.70	11.67	11.65	11.62
9	11.59	11.56	11.54	11.51	11.49	11.46	11.43	11.41	11.38	11.36
10	11.33	11.31	11.28	11.26	11.23	11.21	11.18	11.16	11.13	11.11
11	11.08	11.06	11.03	11.01	10.98	10.96	10.93	10.91	10.89	10.85
12	10.83	10.81	10.78	10.76	10.74	10.72	10.69	10.67	10.65	10.62
13	10.60	10.58	10.55	10.53	10.51	10.49	10.46	10.44	10.42	10.39
14	10.37	10.35	10.33	10.30	10.28	10.26	10.24	10.22	10.19	10.17
15	10.15	10.13	10.11	10.09	10.07	10.05	10.03	10.01	9.99	9.97
16	9.95	9.93	9.91	9.89	9.87	9.84	9.82	9.80	9.78	9.76
17	9.74	9.72	9.70	9.68	9.66	9.64	9.62	9.60	9.58	9.56
18	9.54	9.52	9.50	9.48	9.46	9.44	9.43	9.41	9.39	9.37
19	9.35	9.33	9.31	9.30	9.28	9.26	9.24	9.22	9.21	9.19
20	9.17	9.15	9.13	9.12	9.10	9.08	9.06	9.04	9.03	9.01
21	8.99	8.97	8.96	8.94	8.93	8.91	8.89	8.88	8.86	8.85
22	8.83	8.82	8.80	8.79	8.77	8.76	8.74	8.73	8.71	8.70
23	8.68	8.67	8.65	8.64	8.62	8.61	8.59	8.53	8.56	8.55
24	8.53	8.52	8.50	8.49	8.47	8.46	8.44	8.53	8.41	8.40
25	8.38	8.36	8.35	8.33	8.32	8.30	8.28	8.27	8.25	8.24
26	8.22	8.21	8.19	8.18	8.16	8.15	8.13	8.12	8.10	8.09
27	8.07	8.06	8.04	8.03	8.01	8.00	7.98	7.97	7.95	7.94
28	7.92	7.91	7.89	7.88	7.86	7.85	7.83	7.82	7.80	7.79
29	7.77	7.76	7.74	7.73	7.71	7.70	7.69	7.67	7.66	7.64
30	7.63	7.62	7.60	7.59	7.58	7.57	7.55	7.54	7.53	7.51
31	7.50	7.49	7.48	7.47	7.46	7.45	7.44	7.43	7.42	7.41
32	7.40	7.39	7.38	7.37	7.36	7.35	7.34	7.33	7.32	7.31
33	7.30	7.29	7.28	7.27	7.26	7.25	7.24	7.23	7.22	7.21
34	7.20	7.19	7.18	7.17	7.16	7.15	7.14	7.13	7.12	7.11
35	7.10	7.09	7.08	7.07	7.06	7.05	7.04	7.03	7.02	7.01
36	7.00	6.99	6.98	6.97	6.96	6.95	6.94	6.93	6.92	6.91
37	6.90	6.89	6.88	6.87	6.86	6.85	6.84	6.83	6.82	6.81
38	6.80	6.79	6.78	6.77	6.76	6.75	6.74	6.73	6.72	6.71
39	6.70	6.69	6.68	6.67	6.66	6.65	6.64	6.63	6.62	6.61
40	6.60	6.59	6.58	6.57	6.56	6.55	6.54	6.53	6.52	6.51
41	6.50	6.49	6.48	6.47	6.46	6.45	6.44	6.43	6.42	6.41
42	6.40	6.39	6.38	6.37	6.36	6.35	6.34	6.33	6.32	6.31
43	6.30	6.29	6.28	6.27	6.26	6.25	6.24	6.23	6.22	6.21
44	6.20	6.19	6.18	6.17	6.16	6.15	6.14	6.13	6.12	6.11
45	6.10	6.09	6.08	6.07	6.06	6.05	6.04	6.03	6.02	6.01
46	6.00	5.99	5.98	5.97	5.96	5.95	5.94	5.93	5.92	5.91
47	5.90	5.89	5.88	5.87	5.86	5.85	5.84	5.83	5.82	5.81
48	5.80	5.79	5.78	5.77	5.76	5.75	5.74	5.73	5.72	5.71
49	5.70	5.69	5.68	5.67	5.66	5.65	5.64	5.63	5.62	5.61
50	5.60	5.59	5.58	5.57	5.56	5.55	5.54	5.53	5.52	5.51

Table 2
Correction for measurements
at different altitude

ALTITUDE (METERS)	ATMOSPHERIC PRESSURE KPa	CORRECTION FACTOR
Sea level	101.3	1.00
50	100.7	0.99
100	100.1	0.99
150	99.4	0.98
200	98.8	0.98
300	97.6	0.96
400	96.4	0.95
500	95.2	0.94
600	94.0	0.93
700	92.8	0.92
800	91.7	0.90
900	90.5	0.89
1000	89.4	0.88
1100	88.3	0.87
1200	87.2	0.86
1300	86.1	0.85
1400	85.0	0.84
1500	84.0	0.83
1600	82.9	0.82
1700	81.9	0.81
1800	80.9	0.80
1900	79.9	0.79

Table 3
Correction for salinity effect

°C	Quantity to be subtracted per mg/l of NaCl	°C	Quantity to be subtracted per mg/l of NaCl
0	0.0892	26	0.0410
1	0.0861	27	0.0400
2	0.0830	28	0.0391
3	0.0802	29	0.0382
4	0.0779	30	0.0373
5	0.0749	31	0.0364
6	0.0724	32	0.0356
7	0.0701	33	0.0348
8	0.0678	34	0.0341
9	0.0657	35	0.0333
10	0.0637	36	0.0326
11	0.0618	37	0.0319
12	0.0599	38	0.0312
13	0.0582	39	0.0306
14	0.0565	40	0.0299
15	0.0549	41	0.0293
16	0.0533	42	0.0287
17	0.0519	43	0.0281
18	0.0505	44	0.0275
19	0.0491	45	0.0270
20	0.0478	46	0.0265
21	0.0466	47	0.0259
22	0.0454	48	0.0254
23	0.0442	49	0.0249
24	0.0431	50	0.0244
25	0.0421		

TEMPERATURE CALIBRATION

The temperature scale should be calibrated at least every 3 months or whenever the readings are in doubt.

- Immerse the bottom 60 mm (2.4") of the probe in a beaker containing water.

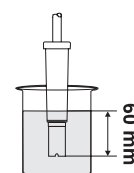

- Switch the knob to the "°C" position and agitate the water for at least 10 minutes to reach the thermal equilibrium between the probe and water.

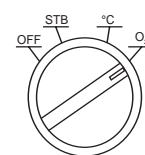

- Using a **ChecktempC** or another thermometer with a resolution of 0.1°C, check the temperature of the water (e.g. 20.0°C).



- Adjust the "°C" trimmer until the display shows the noted temperature.

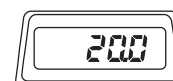

Note: It is important to ensure the thermal equilibrium between probe and water, because 1 degree of temperature difference entails an error of $\pm 3\%$ in dissolved oxygen measurement.

TAKING MEASUREMENTS

Make sure the meter has been calibrated and the protective cap has been removed.

Immerse the tip of the probe in the sample to be tested.

For accurate dissolved oxygen measurements a water movement of at least 0.3 m/sec is required.

This movement will ensure that the oxygen-depleted membrane surface is constantly replenished. A moving stream will provide adequate circulation.

To quickly check if the water speed is sufficient, wait for stable reading and then move the D.O. probe. If the reading remains stable, measurement conditions are correct. If the reading increases, the water movement is too low.

During field measurements, this condition may be met by manually agitating the probe. Accurate readings are not possible while the liquid is at rest.

During laboratory measurements, the use of a magnetic stirrer is recommended. In this way errors due to the diffusion of ambient oxygen in the solution are minimized.

Anyway, the time necessary for reaching the thermal equilibrium between probe and sample must be allowed (a few minutes for a temperature difference of several degrees).



PROBE & MEMBRANE MAINTENANCE

The D.O. probe body is made of reinforced plastic for maximum durability.

A thermistor temperature sensor provides temperature measurements and compensation. When not in use, it is always recommended to protect the probe against damage and dirt with the supplied cap.

To replace the membrane or refill it with electrolyte, proceed as follows:

- Remove the protective cap by gently twisting and pulling it as shown in figure 1.
- Unscrew the membrane by turning it counter-clockwise (see fig.2)
- Wet the sensor by soaking the bottom (2.5 cm / 1") of the probe in **HI 7041S** electrolyte solution for 5 minutes.
- Rinse the new membrane (**HI 76407A**, supplied with the meter) with some electrolyte while shaking gently. Refill with clean electrolyte.
- Gently tap the sides of the membrane with your finger to ensure that no air bubbles remain trapped inside. Do not directly tap the bottom as this will damage the membrane.

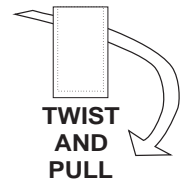

**TWIST
AND
PULL**

fig. 1

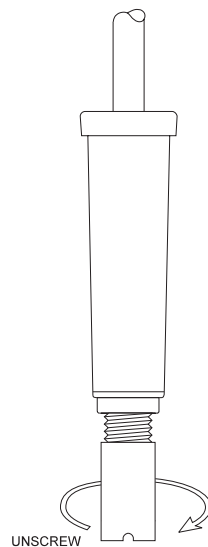

Fig. 2

- Make sure that the rubber O-ring is seated properly inside the membrane cap.

- With the sensor facing down, screw the membrane cap clockwise. Some electrolyte will overflow.

The Platinum cathode (#8 in the Functional Description at page 4) should always be bright and untarnished. If it is tarnished or stained, which could be due to contact with certain gases or extended use with a loose or damaged membrane, the cathode should be cleaned. Use a lint-free cardboard or cloth and rub the cathode very gently side to side 4-5 times. This will be enough to polish and remove any stains without damaging the platinum tip. Afterwards, rinse the probe with deionized or distilled water and install a new membrane cap using fresh electrolyte. Recalibrate the instrument.

Important: In order to have accurate and stable measurements, it is important that the surface of the membrane is in perfect condition. This semi-permeable membrane isolates the sensor elements from the environment but allows oxygen to enter. If any dirt is observed on the membrane, rinse carefully with distilled or deionized water. If any imperfection still exists, or any damage is evident (such as wrinkles or tears), the membrane should be replaced. Make sure that the O-Ring is properly seated in the membrane cap.

BATTERY REPLACEMENT

When the battery level is low, a "V" will be displayed to warn the user that the battery should be replaced.



The meter will still work for approximately 4 hours, then the display will be shut-off to avoid erroneous readings.

Battery replacement must only take place in a safe area and using the battery type specified in this instruction manual.

Slide off the battery cover on the rear of the meter and replace the 9V battery with a new one.

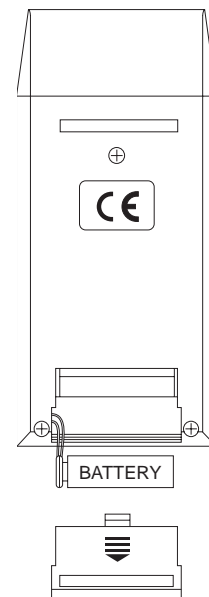

ACCESSORIES

HI 7040M	Zero oxygen solution, 230 mL
HI 7040L	Zero oxygen solution, 500 mL
HI 7041S	Refilling electrolyte solution, 30 mL
HI 710001	Soft carrying case
HI 710009	Shockproof rubber boot, blue
HI 710010	Shockproof rubber boot, orange
HI 76401	D.O. probe with 3 m (10') cable
HI 76407A/P	Spare membrane (5 pcs)

WARRANTY

All Hanna Instruments **meters are warranted for two years** against defects in workmanship and materials when used for their intended purpose and maintained according to the instructions. The **probes are warranted for a period of six months**.

Damages due to accident, misuse, tampering or lack of prescribed maintenance are not covered. This warranty is limited to repair or replacement free of charge.

If service is required, contact the dealer from whom you purchased the instrument. If under warranty, report the model number, date of purchase, serial number and the nature of the failure. If the repair is not covered by the warranty, you will be notified of the charge for repair or replacement. If the instrument is to be returned to Hanna Instruments, obtain a Return Goods Authorization from the Customer Service Department first and then send it with shipment cost prepaid. When shipping any instrument, make sure it is properly packaged for complete protection.

All rights are reserved. Reproduction in whole or in part is prohibited without the written consent of the copyright owner.

Hanna Instruments reserves the right to modify the design, construction and appearance of its products without advance notice.

CE DECLARATION OF CONFORMITY



DECLARATION OF CONFORMITY

We

Hanna Instruments Italia S.r.l.
via E.Fermi, 10
35030 Sarmeola di Rubano - PD
ITALY

herewith certify that the dissolved oxygen meter

HI 8043

has been tested and found to be in compliance with EMC Directive 89/336/EEC and Low Voltage Directive 73/23/EEC according to the following applicable normatives:

EN 50082-1: Electromagnetic Compatibility - Generic Immunity Standard
IEC 801-2 Electrostatic Discharge
IEC 801-3 RF Radiated

EN 50081-1: Electromagnetic Compatibility - Generic Emission Standard
EN 55022 Radiated, Class B

EN61010-1: Safety requirements for electrical equipment for measurement, control and laboratory use

Date of Issue: 16-10-1998

P. Cesa - Technical Director

On behalf of
Hanna Instruments S.r.l.

Recommendations for Users

Before using this product, make sure that it is entirely suitable for the environment in which it is used.

Operation of this instrument in residential area could cause unacceptable interferences to radio and TV equipments, requiring the operator to take all necessary steps to correct interferences.

Any variation introduced by the user to the supplied equipment may degrade the instrument's EMC performance.

To avoid damages or burns, do not perform any measurement in microwave ovens.

SALES AND TECHNICAL SERVICE CONTACTS

Australia:

Tel. (03) 9769.0666 • Fax (03) 9769.0699

China:

Tel. (10) 88570068 • Fax (10) 88570060

Egypt:

Tel. & Fax (02) 2758.683

Germany:

Tel. (07851) 9129-0 • Fax (07851) 9129-99

Greece:

Tel. (210) 823.5192 • Fax (210) 884.0210

Indonesia:

Tel. (21) 4584.2941 • Fax (21) 4584.2942

Japan:

Tel. (03) 3258.9565 • Fax (03) 3258.9567

Korea:

Tel. (02) 2278.5147 • Fax (02) 2264.1729

Malaysia:

Tel. (603) 5638.9940 • Fax (603) 5638.9829

Singapore:

Tel. 6296.7118 • Fax 6291.6906

South Africa:

Tel. (011) 615.6076 • Fax (011) 615.8582

Taiwan:

Tel. 886.2.2739.3014 • Fax 886.2.2739.2983

Thailand:

Tel. 66.2619.0708 • Fax 66.2619.0061

United Kingdom:

Tel. (01525) 850.855 • Fax (01525) 853.668

USA:

Tel. (401) 765.7500 • Fax (401) 765.7575

MAN8043R2 08/05

For e-mail contacts and complete list of Sales and Technical offices, please see www.hannainst.com