

Instruction Manual

HI 83205

Multiparameter Bench Photometer

for Boilers and Cooling Towers

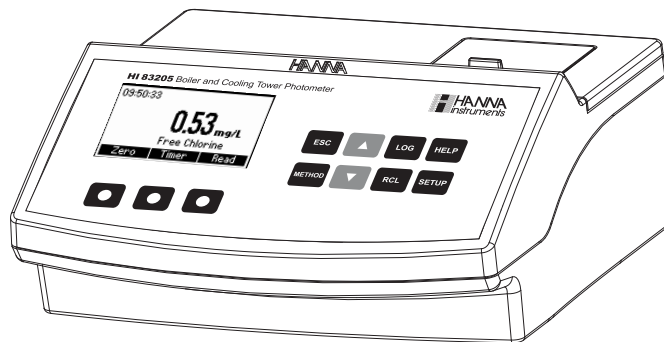

Dear Customer,

Thank you for choosing a Hanna product. Please read this instruction manual carefully before using the instrument. This manual will provide you with the necessary information for the correct use of the instrument. If you need additional technical information, do not hesitate to e-mail us at tech@hannainst.com.

TABLE OF CONTENTS

PRELIMINARY EXAMINATION	3	COPPER HR	38
ABBREVIATIONS	3	COPPER LR	40
GENERAL DESCRIPTION	3	HYDRAZINE	42
SPECIFICATIONS	4	IRON HR	44
PRECISION AND ACCURACY	4	IRON LR	46
PRINCIPLE OF OPERATION	4	MOLYBDENUM	49
FUNCTIONAL DESCRIPTION	6	NITRATE	52
TIPS FOR AN ACCURATE MEASUREMENT	8	NITRITE HR	54
HEALTH & SAFETY	11	NITRITE LR	56
METHOD REFERENCE TABLE	11	DISSOLVED OXYGEN	58
OPERATIONAL GUIDE	12	pH	60
SETUP	14	PHOSPHATE HR	62
HELP MODE	16	PHOSPHATE LR	64
ALUMINUM	17	SILICA	66
AMMONIA MR	19	ZINC	69
AMMONIA LR	21	ERRORS AND WARNINGS	71
BROMINE	23	DATA MANAGEMENT	72
FREE CHLORINE	25	STANDARD METHODS	72
TOTAL CHLORINE	28	ACCESSORIES	73
CHLORINE DIOXIDE	31	WARRANTY	75
CHROMIUM VI HR	34	HANNA LITERATURE	75
CHROMIUM VI LR	36		

All rights are reserved. Reproduction in whole or in part is prohibited without the written consent of the copyright owner, Hanna Instruments Inc., Woonsocket, Rhode Island, 02895, USA.

PRELIMINARY EXAMINATION

Please examine this product carefully. Make sure that the instrument is not damaged. If any damage occurred during shipment, please notify your local Hanna Office.

Each Meter is supplied complete with:

- Two Sample Cuvettes and Caps
- Cloth for wiping cuvettes (1 pcs)
- 60 mL glass bottle for dissolved oxygen analysis (1 pcs)
- Scissors
- AC/DC Power Adapter
- Instruction Manual

Note: Save all packing material until you are sure that the instrument works correctly. Any defective item must be returned in its original packing with the supplied accessories.

ABBREVIATIONS

EPA:	US Environmental Protection Agency
°C:	degree Celsius
°F:	degree Fahrenheit
µg/L:	micrograms per liter (ppb)
mg/L:	milligrams per liter (ppm)
g/L:	grams per liter (ppt)
mL:	milliliter
HR:	high range
MR:	medium range
LR:	low range
PAN:	1-(2-pyridylazo)-2-naphthol
TPTZ:	2,4,6-tri-(2-pyridyl)-1,3,5-triazine

GENERAL DESCRIPTION

HI 83205 is a multiparameter bench photometer dedicated for Boiler and Cooling Towers. It measures 24 different methods using specific liquid or powder reagents. The amount of reagent is precisely dosed to ensure maximum reproducibility.

HI 83205 bench photometer can be connected to a PC via an USB cable. The optional **HI 92000** Windows® Compatible Software helps users manage all their results.

HI 83205 has a powerful interactive user support that assists the user during the analysis process. Each step in the measurement process is help supported. A tutorial mode is available in the Setup Menu.

SPECIFICATIONS

Light Life	Life of the instrument
Light Detector	Silicon Photocell
Environment	0 to 50°C (32 to 122°F); max 90% RH non-condensing
Power Supply	external 12 Vdc power adapter built-in rechargeable battery
Dimensions	235 x 200 x 110 mm (9.2 x 7.87 x 4.33")
Weight	0.9 Kg

For specifications related to each method (e.g. range, resolution, etc.) refer to the related measurement section.

PRECISION AND ACCURACY

Precision is how closely repeated measurements agree with each other. Precision is usually expressed as standard deviation (SD).

Accuracy is defined as the nearness of a test result to the true value.

Although good precision suggests good accuracy, precise results can be inaccurate. The figure explains these definitions.

For each method, the precision is expressed in the related measurement section.

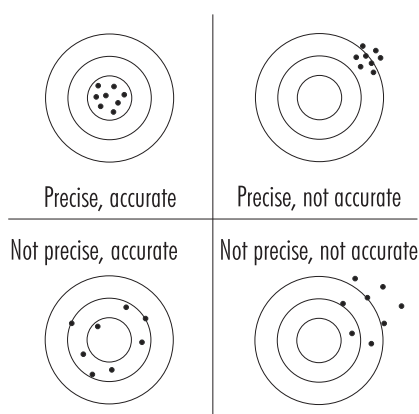

PRINCIPLE OF OPERATION

Absorption of light is a typical phenomenon of interaction between electromagnetic radiation and matter. When a light beam crosses a substance, some of the radiation may be absorbed by atoms, molecules or crystal lattices.

If pure absorption occurs, the fraction of light absorbed depends both on the optical path length through the matter and on the physical-chemical characteristics of substance according to the Lambert-Beer Law:

$$-\log \frac{I}{I_0} = \epsilon_{\lambda} c d$$

or

$$A = \epsilon_{\lambda} c d$$

Where:

- $-\log I/I_0 =$ Absorbance (A)
- $I_0 =$ intensity of incident light beam
- $I =$ intensity of light beam after absorption
- $\epsilon_\lambda =$ molar extinction coefficient at wavelength λ
- $c =$ molar concentration of the substance
- $d =$ optical path through the substance

Therefore, the concentration "c" can be calculated from the absorbance of the substance as the other factors are known.

Photometric chemical analysis is based on the possibility to develop an absorbing compound from a specific chemical reaction between sample and reagents.

Given that the absorption of a compound strictly depends on the wavelength of the incident light beam, a narrow spectral bandwidth should be selected as well as a proper central wavelength to optimize measurements.

The optical system of **HI 83205** is based on special subminiature tungsten lamps and narrow-band interference filters to guarantee both high performance and reliable results.

Four measuring channels allow a wide range of tests.

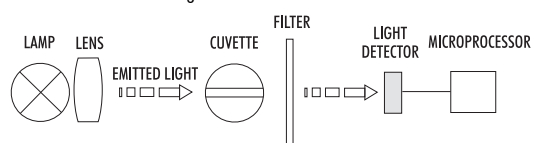

Instrument block diagram (optical layout)

A microprocessor controlled special tungsten lamp emits radiation which is first optically conditioned and beamed through the sample contained in the cuvette. The optical path is fixed by the diameter of the cuvette. Then the light is spectrally filtered to a narrow spectral bandwidth, to obtain a light beam of intensity I_0 or I . The photoelectric cell collects the radiation I that is not absorbed by the sample and converts it into an electric current, producing a potential in the mV range.

The microprocessor uses this potential to convert the incoming value into the desired measuring unit and to display it on the LCD.

The measurement process is carried out in two phases: first the meter is zeroed and then the actual measurement is performed.

The cuvette has a very important role because it is an optical element and thus requires particular attention. It is important that both the measurement and the calibration (zeroing) cuvette are optically identical to provide the same measurement conditions. Most methods use the same cuvette for both, so it is important that measurements take place in the same optical point. The instrument and the cuvette cap have special marks that must be aligned in order to obtain better reproducibility.

The surface of the cuvette must be clean and not scratched. This is to avoid measurement interference due to unwanted reflection and absorption of light. It is recommended not to touch the cuvette walls with hands.

Furthermore, in order to maintain the same conditions during the zeroing and the measurement phases, it is necessary to cap the cuvette to prevent any contamination.

FUNCTIONAL DESCRIPTION



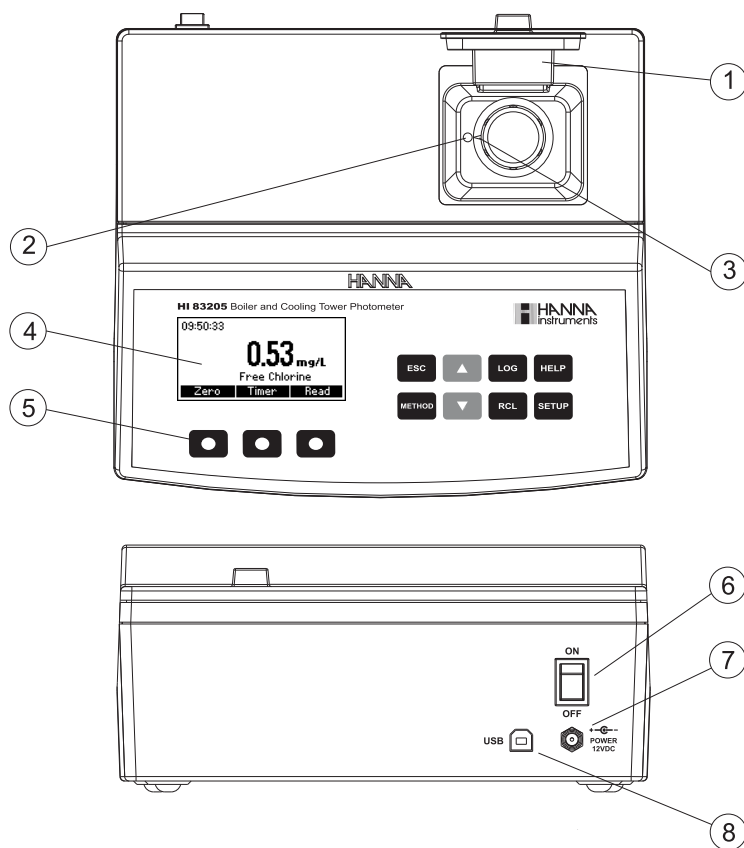





INSTRUMENT DESCRIPTION



- 1) Open Cuvette Lid
- 2) Indexing mark
- 3) Cuvette point
- 4) Liquid Crystal Display (LCD)
- 5) Splash proof keypad
- 6) ON/OFF power switch
- 7) Power input connector
- 8) USB connector

KEYPAD DESCRIPTION

The keypad contains 8 direct keys and 3 functional keys with the following functions:

-  Press to perform the function displayed above it on the LCD.
-  Press to exit the current screen.
-  Press to access the select method menu.
-  Press to move up in a menu or a help screen, to increment a set value, to access second level functions.
-  Press to move down in a menu or a help screen, to decrement a set value, to access second level functions.
-  Press to log the current reading.
-  Press to recall the log.
-  Press to display the help screen.
-  Press to access the setup screen.

TIPS FOR AN ACCURATE MEASUREMENT

The instructions listed below should be carefully followed during testing to ensure most accurate results.

- Color or suspended matter in large amounts may cause interference, and should be removed by treatment with active carbon and filtration.
- Ensure the cuvette is filled correctly: the liquid in the cuvette forms a convexity on the top; the bottom of this convexity must be at the same level as the 10 mL mark.

COLLECTING AND MEASURING SAMPLES

- In order to measure exactly 0.5 mL of reagent with the 1 mL syringe:
 - (a) push the plunger completely into the syringe and insert the tip into the solution.
 - (b) pull the plunger up until the lower edge of the seal is exactly on the 0.0 mL mark.
 - (c) take out the syringe and clean the outside of the syringe tip. Be sure that no drops are hanging on the tip of the syringe, if so eliminate them. Then, keeping the syringe in vertical position above the cuvette, push the plunger down into the syringe until the lower edge of the seal is exactly on the 0.5 mL mark. Now the exact amount of 0.5 mL has been added to the cuvette, even if the tip still contains some solution.

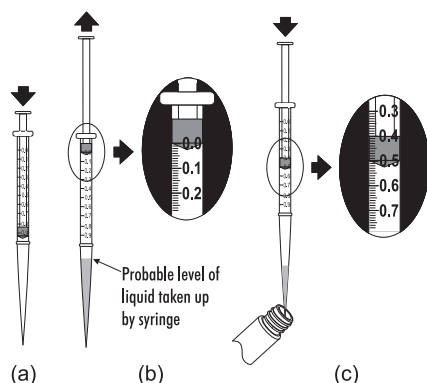

USING LIQUID AND POWDER REAGENTS

- Proper use of the dropper:
 - (a) for reproducible results, tap the dropper on the table for several times and wipe the outside of the dropper tip with a cloth.
 - (b) always keep the dropper bottle in a vertical position while dosing the reagent.



- Proper use of the powder reagent packet:
 - (a) use scissors to open the powder packet;
 - (b) push the edges of the packet to form a spout;
 - (c) pour out the content of the packet.

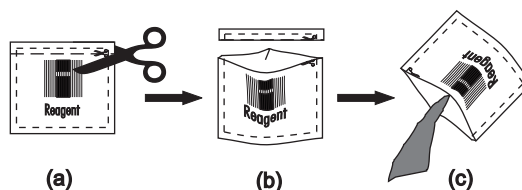

USING CUVETTES

- Proper mixing is very important for reproducibility of the measurements. The right way of mixing a cuvette is specified for each method in the related chapter.
 - (a) **invert the cuvette** a couple of times or for a specified time: hold the cuvette in the vertical position. Turn the cuvette upside-down and wait for all of the solution to flow to the cap end, then return the cuvette to the upright vertical position and wait for all of the solution to flow to the cuvette bottom. This is one inversion. The correct speed for this mixing technique is 10-15 complete inversions in 30 seconds.

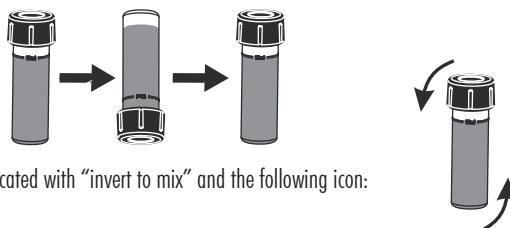

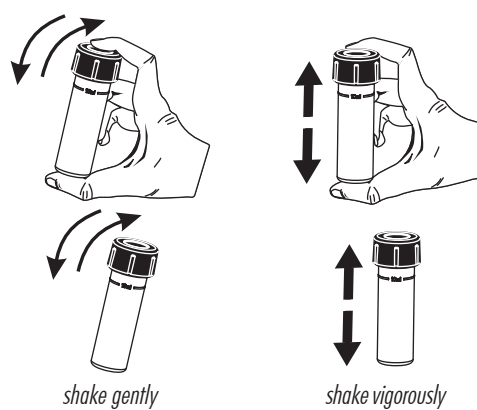

This mixing technique is indicated with "invert to mix" and the following icon:

- (b) **shaking the cuvette**, moving the cuvette up and down. The movement may be gentle or vigorous. This mixing method is indicated with "shake gently" or "shake vigorously", and one of the following icons:

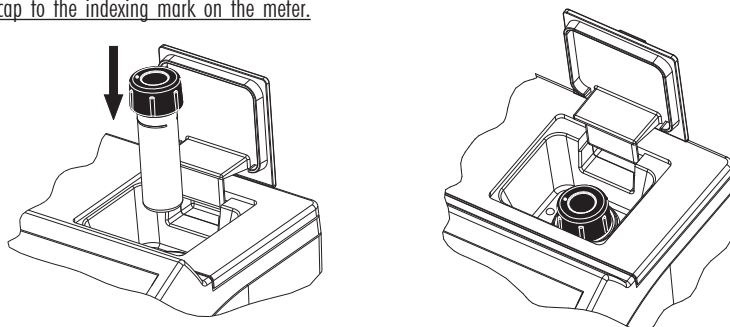

- Pay attention to push the cuvette completely down in the holder and to align the white point on the cap to the indexing mark on the meter.



- In order to avoid reagent leaking and to obtain more accurate measurements, close the cuvette first with the supplied HDPE plastic stopper  and then the black cap.
- Each time the cuvette is used, the cap must be tightened to the same degree.
- Whenever the cuvette is placed into the measurement cell, it must be dry outside, and free of fingerprints, oil or dirt. Wipe it thoroughly with **HI 731318** or a lint-free cloth prior to insertion.
- Shaking the cuvette can generate bubbles in the sample, causing higher readings. To obtain accurate measurements, remove such bubbles by swirling or by gently tapping the cuvette.
- Do not let the reacted sample stand too long after reagent is added. For best accuracy, respect the timings described in each specific method.
- It is possible to take multiple readings in a row, but it is recommended to take a new zero reading for each sample and to use the same cuvette for zeroing and measurement when possible (for most precise results follow the measurement procedures carefully).
- Discard the sample immediately after the reading is taken, or the glass might become permanently stained.
- All the reaction times reported in this manual are at 25 °C (77 °F). In general, the reaction time should be increased for temperatures lower than 20 °C (68 °F), and decreased for temperatures higher than 25 °C (77 °F).

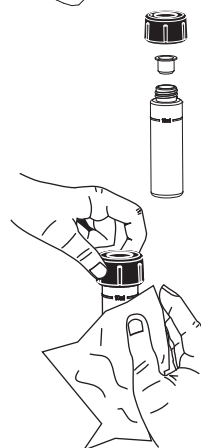

INTERFERENCES

- In the method measurement section the most common interferences that may be present in an average sample matrix have been reported. It may be that for a particular treatment process other compounds do interfere with the method of analysis.

HEALTH & SAFETY



- The chemicals contained in the reagent kits may be hazardous if improperly handled.
- Read the Material Safety Data Sheet (MSDS) before performing tests.
- Safety equipment: Wear suitable eye protection and clothing when required, and follow instructions carefully.
- Reagent spills: If a reagent spill occurs, wipe up immediately and rinse with plenty of water. If reagent contacts skin, rinse the affected area thoroughly with water. Avoid breathing released vapors.
- Waste disposal: for proper disposal of reagent kits and reacted samples, refer to the Material Safety Data Sheet (MSDS).

METHOD REFERENCE TABLE

Method	Method description	Page	Method	Method description	Page
1	Aluminum	17	13	Iron HR	44
2	Ammonia MR	19	14	Iron LR	46
3	Ammonia LR	21	15	Molybdenum	49
4	Bromine	23	16	Nitrate	52
5	Free Chlorine	25	17	Nitrite HR	54
6	Total Chlorine	28	18	Nitrite LR	56
7	Chlorine Dioxide	31	19	Dissolved Oxygen	58
8	Chromium VI HR	34	20	pH	60
9	Chromium VI LR	36	21	Phosphate HR	62
10	Copper HR	38	22	Phosphate LR	64
11	Copper LR	40	23	Silica	66
12	Hydrazine	42	24	Zinc	69

OPERATIONAL GUIDE

POWER CONNECTION AND BATTERY MANAGEMENT

The meter can be powered from an AC/DC adapter (included) or from the built-in rechargeable battery.

Note: Always turn the meter off before unplugging it to ensure no data is lost.

When the meter switches ON, it verifies if the power supply adapter is connected. The battery icon on the LCD will indicate the battery status:

- battery is charging from external adapter
- battery fully charged (meter connected to AC/DC adapter)

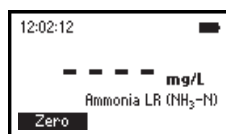
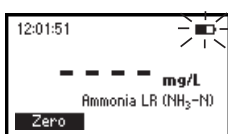

- battery capacity (no external adapter)
- battery Low (no external adapter)

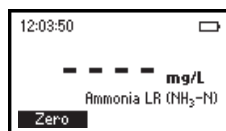
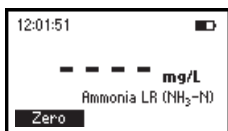

- battery Dead (no external adapter)



METHOD SELECTION

- Turn the instrument ON via the ON/OFF power switch.
- The meter will perform an autodiagnostic test. During this test, the Hanna Instrument logo will appear on the LCD. After 5 seconds, if the test was successful, the last method used will appear on the display.
- In order to select the desired method press the **METHOD** key and a screen with the available methods will appear.
- Press the ▲ ▼ keys to highlight the desired method. Press **Select**.

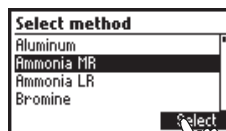
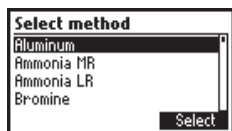

- After the desired method is selected, follow the measurement described in the related section.
- Before performing a test you should read all the instructions carefully.

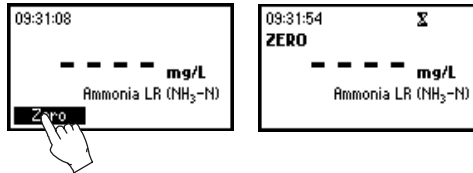

DATA MANAGEMENT

The instrument features a data log function to help you keep track of all your analysis. The data log can hold 200 individual measurements. Storing, viewing and deleting the data is possible using the **LOG** and **RCL** keys.

Storing data: You can store only a valid measurement. Press **LOG** and the last valid measurement will be stored with date and time stamps.

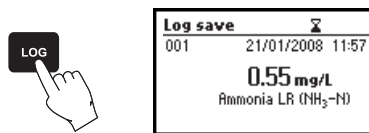

Viewing and deleting: You can view and delete the data log by pressing the **RCL** key. You can only delete the last saved measurement. Additionally, you can delete the data records all at once.

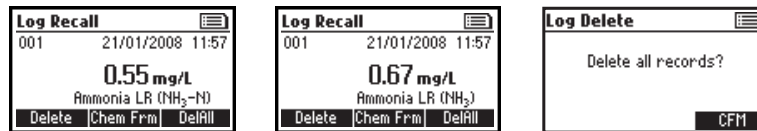

CHEMICAL FORM

Chemical form conversion factors are pre-programmed into the instrument and are method specific. In order to view the displayed result in the desired chemical form press **▲** or **▼** to access the second level functions and then press the **Chem Frm** functional key to toggle between the available chemical forms for the selected method.

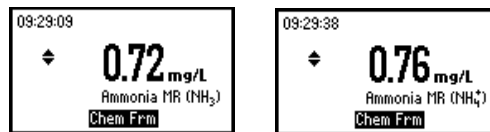

SETUP

In the Setup mode the instrument's parameters can be changed. Some parameters affect the measuring sequence and others are general parameters that change the behavior or appearance of the instrument.

Press **SETUP** to enter the setup mode.

Press **ESC** or **SETUP** to return to the main screen.

A list of setup parameters will be displayed with currently configured settings. Press **HELP** for additional information.

Press the ▲ ▼ keys to select a parameter and change the value as follows:



Backlight

Values: 0 to 8.

Press the **Modify** key to access the backlight value.

Use the ◀ ▶ functional keys or the ▲ ▼ keys to increase or decrease the value.

Press the **Accept** key to confirm or **ESC** to return to the setup menu without saving the new value.

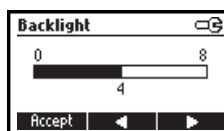
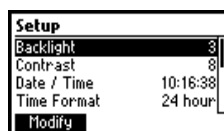

Contrast

Values: 0 to 20.

This option is used to set the display's contrast.

Press the **Modify** key to change the display's contrast.

Use the ◀ ▶ functional keys or the ▲ ▼ keys to increase or decrease the value.

Press the **Accept** key to confirm the value or **ESC** to return to the setup menu without saving the new value.

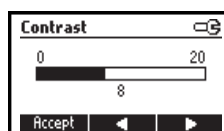
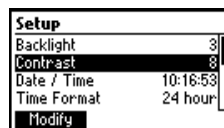

Date / Time

This option is used to set the instrument's date and time.

Press the **Modify** key to change the date/time.

Press the ◀ ▶ functional keys to highlight the value to be modified (year, month, day, hour, minute or second). Use the ▲ ▼ keys to change the value.

Press the **Accept** key to confirm or **ESC** to return to the setup without saving the new date or time.

Time format

Option: AM/PM or 24 hour.

Press the functional key to select the desired time format.

Date format

Press the **Modify** key to change the Date Format.

Use the ▲ ▼ keys to select the desired format.

Press the **Accept** key to confirm or **ESC** to return to the setup menu without saving the new format.

Language

Press the corresponding key to change the language.

If the new language cannot be loaded, the previously selected language will be reloaded.

Tutorial

Option: Enable or Disable.

If enabled this option will provide the user short guide related to the current screen.

Press the functional key to enable/disable the tutorial mode.

Beeper

Option: Enable or Disable.

When enabled, a short beep is heard every time a key is pressed. A long beep alert sounds when the pressed key is not active or an error condition is detected.

Press the functional key to enable/disable the beeper.

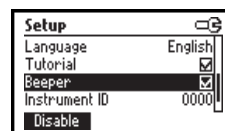
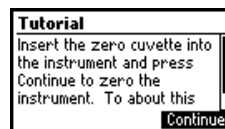
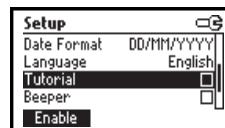
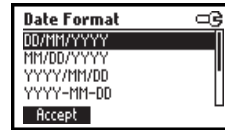
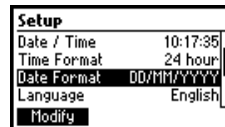
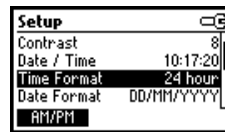
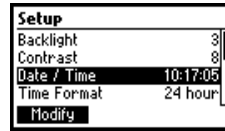

Instrument ID

Option: 0 to 9999.

This option is used to set the instrument's ID (identification number). The instrument ID is used while exchanging data with a PC.

Press the **Modify** key to access the instrument ID screen. Press the **▲ ▼** keys in order to set the desired value.

Press the **Accept** key to confirm the value or **ESC** to return to the setup menu without saving the new value.

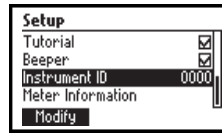

Meter information

Press the **Select** key to view the instrument model, firmware version, language version and instrument serial number.

Press **ESC** to return to the Setup mode.

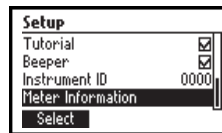

HELP MODE

HI 83205 offers an interactive contextual help mode that assists the user at any time.

To access the help screens press **HELP**.

The instrument will display additional information related to the current screen. To read all the available information, scroll the text using the **▲ ▼** keys.

Press the **Support** key to access a screen with Hanna service centers and their contact details.

Press the **Accessories** key to access a list of instrument reagents and accessories.

To exit support or accessories screens press **ESC** and the instrument will return to the previous help screen.

To exit help mode press the **HELP** or **ESC** key again and the meter will return to the previously selected screen.

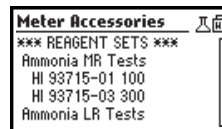
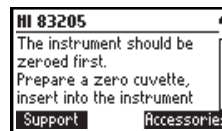

ALUMINUM

SPECIFICATIONS

Range	0.00 to 1.00 mg/L
Resolution	0.01 mg/L
Accuracy	± 0.02 mg/L $\pm 4\%$ of reading at 25 °C
Typical EMC	± 0.01 mg/L
Deviation	
Light Source	Tungsten lamp with narrow band interference filter @ 525 nm
Method	Adaptation of the aluminon method. The reaction between aluminum and reagents causes a reddish tint in the sample.

REQUIRED REAGENTS

Code	Description	Quantity
HI 93712A-0	Ascorbic acid	1 packet
HI 93712B-0	Aluminon reagent	1 packet
HI 93712C-0	Bleaching powder	1 packet

REAGENT SETS

HI 93712-01 Reagents for 100 tests

HI 93712-03 Reagents for 300 tests

For other accessories see page 73.

MEASUREMENT PROCEDURE

- Select the *Aluminum* method using the procedure described in the *Method Selection* section (see page 12).
- Fill a graduated beaker with 50 mL of sample.
- Add the content of one packet of HI 93712A-0 Ascorbic Acid and mix until completely dissolved.
- Add the content of one packet of HI 93712B-0 Aluminon Reagent and mix until completely dissolved. This is the sample.
- Fill two cuvettes with 10 mL of sample each (up to the mark).

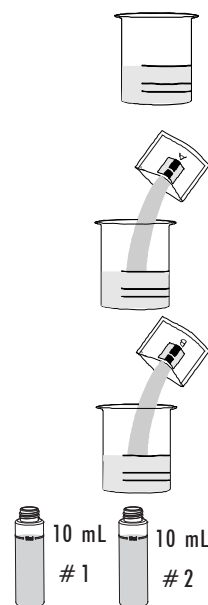

Aluminum

- Add the content of one packet of HI 93712C-0 Bleaching Powder to one of the two cuvettes. Replace the cap and shake vigorously until completely dissolved. This is the blank.

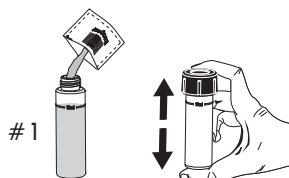

- Place the blank into the holder and close the lid.
- Press **Timer** and the display will show the countdown prior to zeroing the blank. Alternatively wait for 15 minutes and then press **Zero**. The display will show “-0.0-” when the meter is zeroed and ready for measurement.

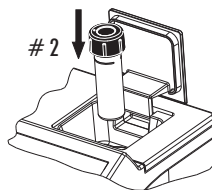
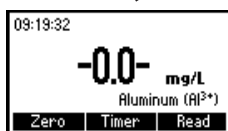
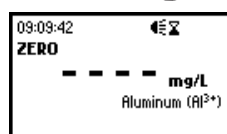
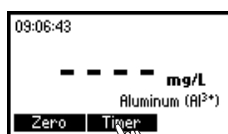
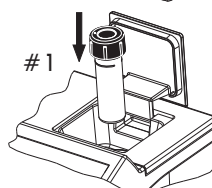

- Remove the blank and insert the other cuvette into the instrument.
- Press the **Read** key and the meter will perform the reading. The instrument displays the results in mg/L of aluminum.

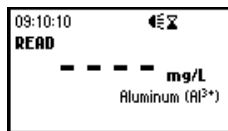
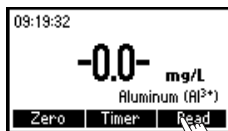

- Press ▲ or ▼ to access the second level functions.
- Press the **Chem Frm** key to convert the result in mg/L of Al₂O₃.

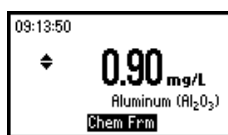

- Press ▲ or ▼ to return to the measurement screen.

INTERFERENCES

Interference may be caused by:

Iron above 20 mg/L, Alkalinity above 1000 mg/L, Phosphate above 50 mg/L; Fluoride must be absent.

AMMONIA MEDIUM RANGE

SPECIFICATIONS

Range	0.00 to 10.00 mg/L
Resolution	0.01 mg/L
Accuracy	± 0.05 mg/L $\pm 5\%$ of reading at 25 °C
Typical EMC	± 0.01 mg/L
Deviation	
Light Source	Tungsten lamp with narrow band interference filter @ 420 nm
Method	Adaptation of the <i>ASTM Manual of Water and Environmental Technology, D1426-92</i> , Nessler method. The reaction between ammonia and reagents causes a yellow tint in the sample.

REQUIRED REAGENTS

<u>Code</u>	<u>Description</u>	<u>Quantity</u>
HI 93715A-0	First Reagent	4 drops (6 drops for seawater)
HI 93715B-0	Second Reagent	4 drops (10 drops for seawater)

REAGENT SETS

HI 93715-01 Reagents for 100 tests

HI 93715-03 Reagents for 300 tests

For other accessories see page 73.

MEASUREMENT PROCEDURE

- Select the *Ammonia MR* method using the procedure described in the *Method Selection* section (see page 12).
- Fill the cuvette with 10 mL of unreacted sample (up to the mark) and replace the cap.
- Place the cuvette into the holder and close the lid.
- Press the **Zero** key. The display will show “-0.0-” when the meter is zeroed and ready for measurement.

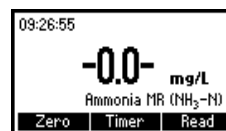
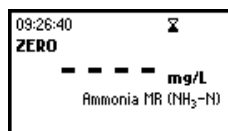
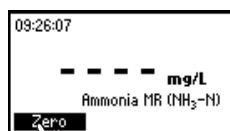
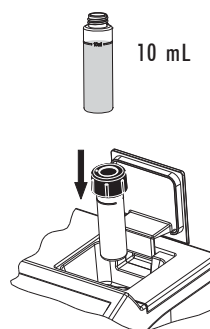

- Remove the cuvette.
- Add 4 drops of HI 93715A-0 First reagent (6 drops for seawater analysis). Replace the cap and mix the solution.
- Add 4 drops of HI 93715B-0 Second reagent (10 drops for seawater analysis). Replace the cap and mix the solution.
- Reinsert the cuvette into the instrument.
- Press **Timer** and the display will show the countdown prior to the measurement or, alternatively, wait for 3 minutes and 30 seconds and press **Read**. When the timer ends the meter will perform the reading. The instrument displays the results in **mg/L of ammonia nitrogen (NH₃-N)**.

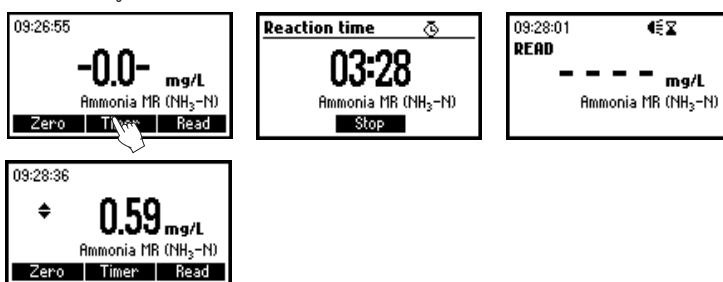
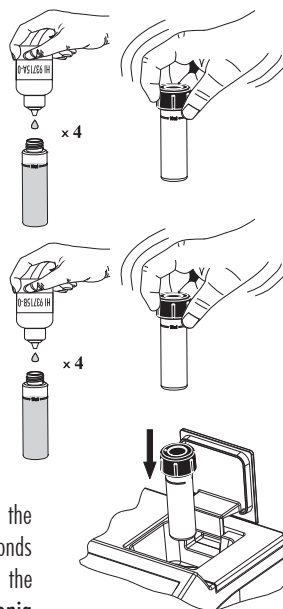

- Press ▲ or ▼ to access the second level functions.
- Press the **Chem Frm** key to convert the result in mg/L of ammonia (NH₃) and ammonium (NH₄⁺).

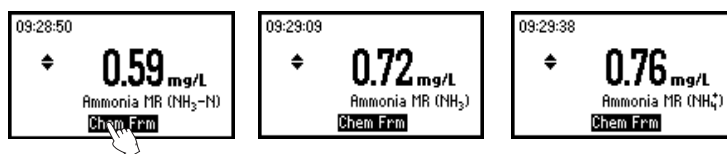

- Press ▲ or ▼ to return to the measurement screen.

INTERFERENCES

Interference may be caused by:

acetone, alcohols, aldehydes, glycine, hardness above 1 g/L, iron, organic chloramines, sulfide, various aliphatic and aromatic amines.

AMMONIA LOW RANGE

SPECIFICATIONS

Range	0.00 to 3.00 mg/L
Resolution	0.01 mg/L
Accuracy	±0.04 mg/L ±4% of reading at 25 °C
Typical EMC Deviation	±0.01 mg/L
Light Source	Tungsten lamp with narrow band interference filter @ 420 nm
Method	Adaptation of the <i>ASTM Manual of Water and Environmental Technology, D1426-92</i> , Nessler method. The reaction between ammonia and reagents causes a yellow tint in the sample.

REQUIRED REAGENTS

<u>Code</u>	<u>Description</u>	<u>Quantity</u>
HI 93700A-0	First Reagent	4 drops (6 drops for seawater)
HI 93700B-0	Second Reagent	4 drops (10 drops for seawater)

REAGENT SETS

HI 93700-01 Reagents for 100 tests

HI 93700-03 Reagents for 300 tests

For other accessories see page 73.

MEASUREMENT PROCEDURE

- Select the *Ammonia LR* method using the procedure described in the *Method Selection* section (see page 12).
- Fill the cuvette with 10 mL of unreacted sample (up to the mark) and replace the cap.
- Place the cuvette into the holder and close the lid.
- Press the **Zero** key. The display will show “-0.0-” when the meter is zeroed and ready for measurement.

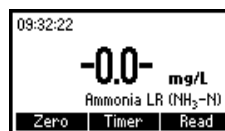
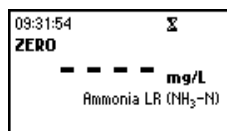
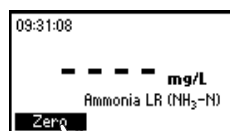
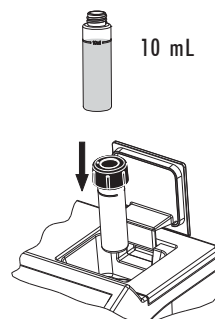

- Remove the cuvette.
- Add 4 drops of HI 93700A-0 First reagent (6 drops for seawater analysis). Replace the cap and mix the solution.

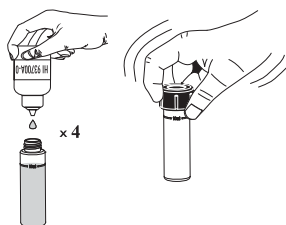

- Add 4 drops of HI 93700B-0 Second reagent (10 drops for seawater analysis). Replace the cap and mix the solution.

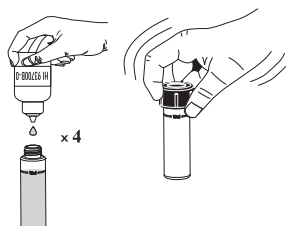

- Reinsert the cuvette into the instrument.

- Press **Timer** and the display will show the countdown prior to the measurement or, alternatively, wait for 3 minutes and 30 seconds and press **Read**. When the timer ends the meter will perform the reading. The instrument displays the results in **mg/L of ammonia nitrogen (NH₃-N)**.

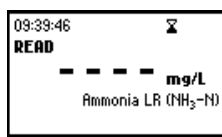
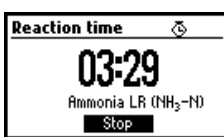
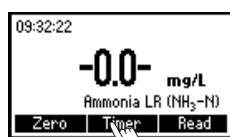
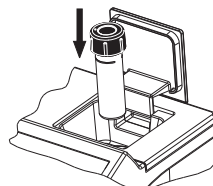

- Press ▲ or ▼ to access the second level functions.
- Press the **Chem Frm** key to convert the result in mg/L of ammonia (NH₃) and ammonium (NH₄⁺).

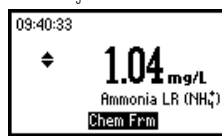
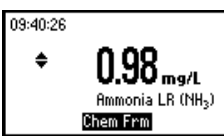
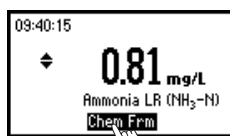

- Press ▲ or ▼ to return to the measurement screen.

INTERFERENCES

Interference may be caused by: acetone, alcohols, aldehydes, glycine, hardness above 1 g/L, iron, organic chloramines, sulfide, various aliphatic and aromatic amines.

BROMINE

SPECIFICATIONS

Range	0.00 to 8.00 mg/L
Resolution	0.01 mg/L
Accuracy	± 0.08 mg/L $\pm 3\%$ of reading at 25 °C
Typical EMC	± 0.01 mg/L
Deviation	
Light Source	Tungsten lamp with narrow band interference filter @ 525 nm
Method	Adaptation of the <i>Standard Methods for the Examination of Water and Wastewater, 18th edition</i> , DPD method. The reaction between bromine and the reagent causes a pink tint in the sample.

REQUIRED REAGENTS

<u>Code</u>	<u>Description</u>	<u>Quantity</u>
HI 93716-0	DPD Reagent	1 packet

REAGENT SETS

HI 93716-01 Reagents for 100 tests

HI 93716-03 Reagents for 300 tests

For other accessories see page 73.

MEASUREMENT PROCEDURE

- Select the *Bromine* method using the procedure described in the *Method Selection* section (see page 12).
- Fill the cuvette with 10 mL of unreacted sample (up to the mark) and replace the cap.
- Place the cuvette into the holder and close the lid.

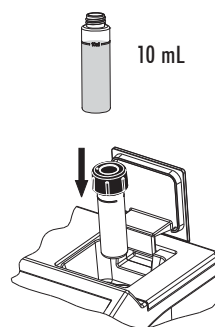

- Press the **Zero** key. The display will show “-0.0-” when the meter is zeroed and ready for measurement.

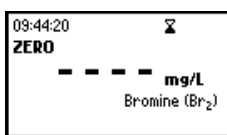
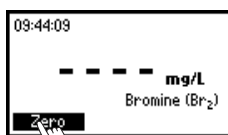

- Remove the cuvette and add the content of one packet of HI 93716-0 DPD reagent. Replace the cap and shake gently for about 20 seconds to dissolve most of the reagent.

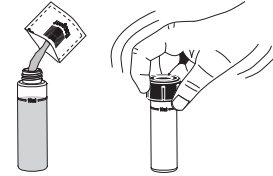

- Reinsert the cuvette into the instrument.

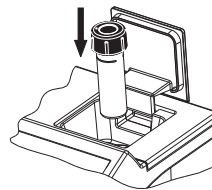

- Press **Timer** and the display will show the countdown prior to the measurement or, alternatively, wait for 2 minutes and 30 seconds and press **Read**. When the timer ends the meter will perform the reading.

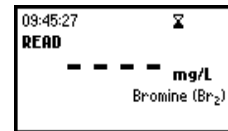
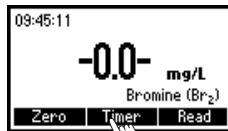

- The instrument displays the results in mg/L of bromine.



INTERFERENCES

Interference may be caused by: Chlorine, Iodine, Ozone, Oxidized forms of Chromium and Manganese.

In case of water with hardness greater than 500 mg/L CaCO₃, shake the sample for approximately 2 minutes after adding the reagent.

In case of water with alkalinity greater than 250 mg/L CaCO₃ or acidity greater than 150 mg/L CaCO₃, the color of the sample may develop only partially, or may rapidly fade. To resolve this, neutralize the sample with diluted HCl or NaOH.

FREE CHLORINE

SPECIFICATIONS

Range	0.00 to 2.50 mg/L
Resolution	0.01 mg/L
Accuracy	± 0.03 mg/L $\pm 3\%$ of reading at 25 °C
Typical EMC	± 0.01 mg/L
Deviation	
Light Source	Tungsten lamp with narrow band interference filter @ 525 nm
Method	Adaptation of the <i>EPA DPD method 330.5</i> . The reaction between free chlorine and the DPD reagent causes a pink tint in the sample.

REQUIRED REAGENTS

POWDER:

Code	Description	Quantity
HI 93701-0	DPD	1 packet

LIQUID:

Code	Description	Quantity
HI 93701A-F	DPD1 Indicator	3 drops
HI 93701B-F	DPD1 Buffer	3 drops

REAGENT SETS

HI 93701-F Reagents for 300 tests (liquid)

HI 93701-01 Reagents for 100 tests (powder)

HI 93701-03 Reagents for 300 tests (powder)

For other accessories see page 73.

MEASUREMENT PROCEDURE

- Select the *Free Chlorine* method using the procedure described in the *Method Selection* section (see page 12).
- Fill the cuvette with 10 mL of unreacted sample (up to the mark) and replace the cap.
- Place the cuvette into the holder and close the lid.

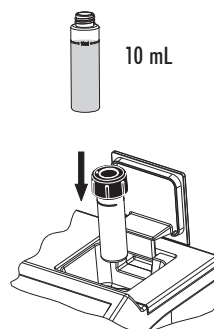

- Press the **Zero** key. The meter will show “-0.0-” when the meter is zeroed and ready for measurement.



- Remove the cuvette.

Powder reagents procedure

- Add the content of one packet of HI 93701-0 DPD reagent. Replace the cap and shake gently for 20 seconds (or 2 minutes for seawater analysis).

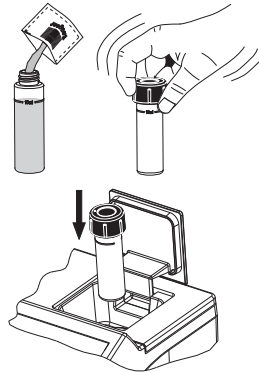

- Reinsert the cuvette into the instrument.

- Press **Timer** and the display will show the countdown prior to the measurement or, alternatively, wait for 1 minute and press **Read**. When the timer ends the meter will perform the reading. The instrument displays the results in **mg/L** of free chlorine.



Liquid reagents procedure

- To an empty cuvette add 3 drops of HI 93701A-F DPD1 indicator and 3 drops of HI 93701B-F DPD1 buffer. Swirl gently to mix, and immediately add 10 mL of unreacted sample. Replace the cap and shake gently again.

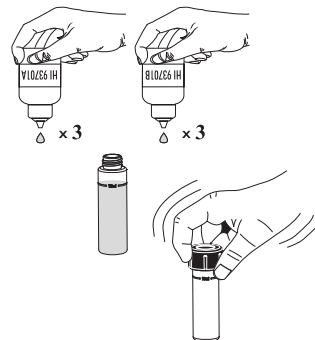

- Reinsert the cuvette into the instrument.

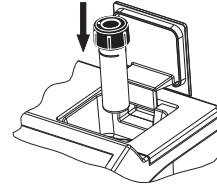

- Press **Read** to start the reading. The instrument displays the results in **mg/L** of free chlorine.

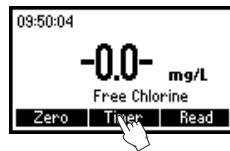

INTERFERENCES

Interference may be caused by: Bromine, Iodine, Ozone, Oxidized forms of Chromium and Manganese.

In case of water with hardness greater than 500 mg/L CaCO₃, shake the sample for approximately 2 minutes after adding the powder reagent.

In case of water with alkalinity greater than 250 mg/L CaCO₃ or acidity greater than 150 mg/L CaCO₃, the color of the sample may develop only partially, or may rapidly fade. To resolve this, neutralize the sample with diluted HCl or NaOH.

TOTAL CHLORINE

SPECIFICATIONS

Range	0.00 to 3.50 mg/L
Resolution	0.01 mg/L
Accuracy	± 0.03 mg/L $\pm 3\%$ of reading at 25 °C
Typical EMC	± 0.01 mg/L
Deviation	
Light Source	Tungsten lamp with narrow band interference filter @ 525 nm
Method	Adaptation of the <i>EPA DPD method 330.5</i> . The reaction between the chlorine and the DPD reagent causes a pink tint in the sample.

REQUIRED REAGENTS

POWDER:

Code	Description	Quantity
HI 93711-0	DPD	1 packet

LIQUID:

Code	Description	Quantity
HI 93701A-T	DPD1 indicator	3 drops
HI 93701B-T	DPD1 buffer	3 drops
HI 93701C	DPD3 solution	1 drop

REAGENT SETS

- HI 93701-T Reagents for 300 total chlorine tests (liquid)
 - HI 93711-01 Reagents for 100 total chlorine tests (powder)
 - HI 93711-03 Reagents for 300 total chlorine tests (powder)
- For other accessories see page 73.

MEASUREMENT PROCEDURE

- Select the *Total Chlorine* method using the procedure described in the *Method Selection* section (see page 12).
- Fill the cuvette with 10 mL of unreacted sample (up to the mark) and replace the cap.
- Place the cuvette into the holder and close the lid.

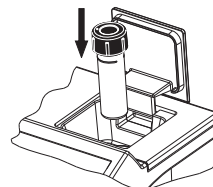

- Press the **Zero** key. The meter will show “-0.0-” when the meter is zeroed and ready for measurement.

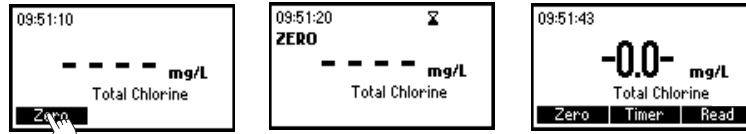

- Remove the cuvette.

Powder reagents procedure

- Add 1 packet of HI 93711-0 DPD reagent. Replace the cap and shake gently for 20 seconds (or 2 minutes for seawater analysis).
- Reinsert the cuvette into the instrument.
- Press **Timer** and the display will show the countdown prior to the measurement or, alternatively, wait for 2 minutes and 30 seconds and press **Read**. When the timer ends the meter will perform the reading. The instrument displays the results in **mg/L of total chlorine**.

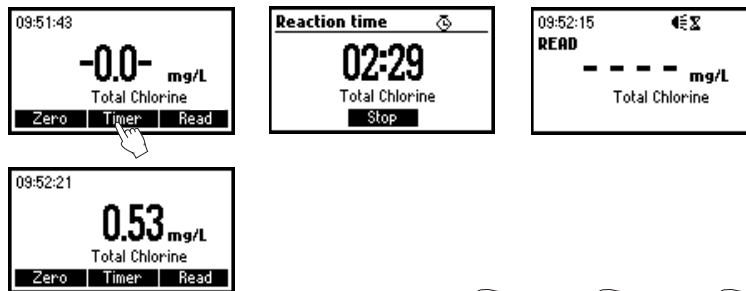
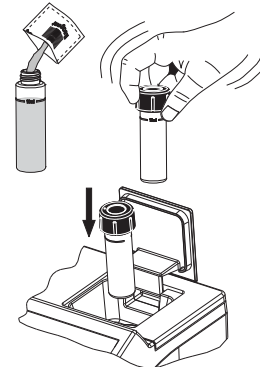

Liquid reagents procedure

- To an empty cuvette add 3 drops of HI 93701A-T DPD1 indicator, 3 drops of HI 93701B-T DPD1 buffer and 1 drop of HI 93701C DPD3 solution. Swirl gently to mix and **immediately** add 10 mL of unreacted sample. Replace the cap and shake gently again.

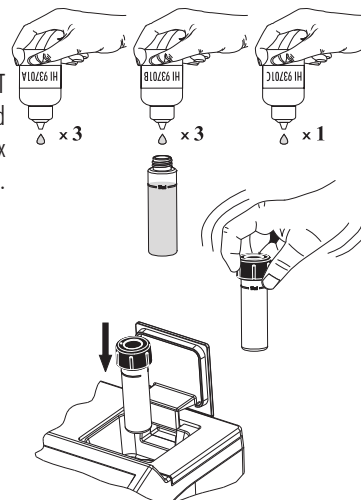

- Reinsert the cuvette into the instrument.

- Press **Timer** and the display will show the countdown prior to the measurement or, alternatively, wait for 2 minutes and 30 seconds and press **Read**. When the timer ends the meter will perform the reading.



- The instrument displays the results in mg/L of total chlorine.



Note: free and total chlorine have to be measured separately with fresh unreacted samples following the related procedure if both values are requested.

INTERFERENCES

Interference may be caused by: Bromine, Iodine, Ozone, Oxidized forms of Chromium and Manganese.

In case of water with hardness greater than 500 mg/L CaCO₃, shake the sample for approximately 2 minutes after adding the powder reagent.

In case of water with alkalinity greater than 250 mg/L CaCO₃ or acidity greater than 150 mg/L CaCO₃, the color of the sample may develop only partially, or may rapidly fade. To resolve this, neutralize the sample with diluted HCl or NaOH.

CHLORINE DIOXIDE

SPECIFICATIONS

Range	0.00 to 2.00 mg/L
Resolution	0.01 mg/L
Accuracy	± 0.10 mg/L $\pm 5\%$ of reading at 25 °C
Typical EMC	± 0.01 mg/L
Deviation	
Light Source	Tungsten lamp with narrow band interference filter @ 575 nm
Method	Adaptation of the Chlorophenol Red method. The reaction between chlorine dioxide and reagents causes a colorless to purple tint in the sample.

REQUIRED REAGENT

Code	Description	Quantity
HI 93738A-0	Reagent A	1 mL
HI 93738B-0	Dechlorinating Reagent B	1 packet
HI 93738C-0	Reagent C	1 mL
HI 93738D-0	Reagent D	1 mL

REAGENT SETS

HI 93738-01 Reagents for 100 tests

HI 93738-03 Reagents for 300 tests

For other accessories see page 73.

MEASUREMENT PROCEDURE

- Select the *Chlorine Dioxide* method using the procedure described in the *Method Selection* section (see page 12).
- Fill two graduated mixing cylinders (#1 & #2) up to the 25 mL mark with the sample.
- Add 0.5 mL of HI 93738A-0 Chlorine Dioxide Reagent to each cylinder (#1 & #2), close them and invert several times to mix.

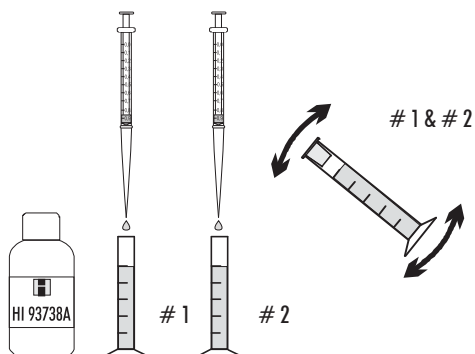
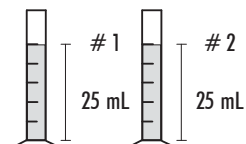

- Add the content of one packet of HI 93738B-0 Dechlorinating Reagent to one of the two cylinders (#1), close and invert it several times until it is totally dissolved. This is the blank.

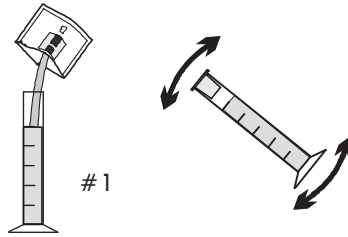

- Add precisely 0.5 mL of HI 93738C-0 Chlorine Dioxide Reagent to each cylinder (#1 & #2), close them and invert several times to mix.

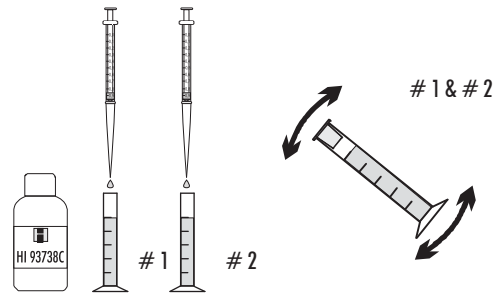

- Add 0.5 mL of HI 93738D-0 Chlorine Dioxide Reagent to each cylinder (#1 & #2), close them and invert several times to mix. Cylinder #2 is the reacted sample.

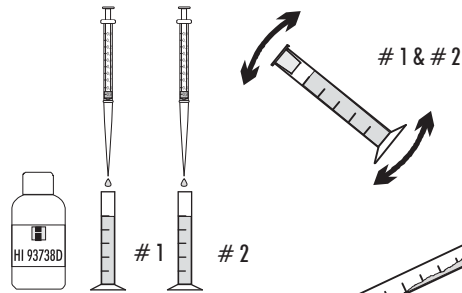

- Fill a cuvette with 10 mL of the blank (#1) up to the mark and replace the cap.
- Place the blank (#1) into the holder and close the lid.

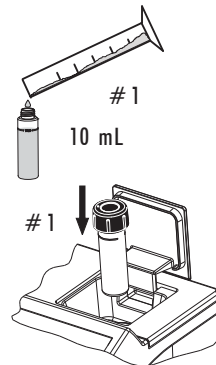

- Press the **Zero** key. The meter will show “-0.0-” when the meter is zeroed and ready for measurement.

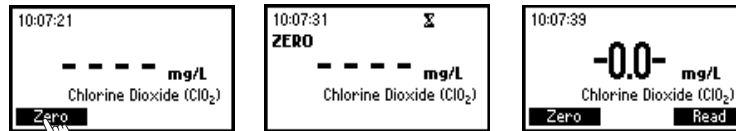

- Fill another cuvette with 10 mL of the reacted sample (#2) up to the mark and replace the cap.

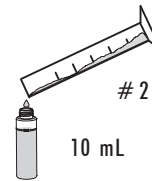

- Insert the sample into the instrument.

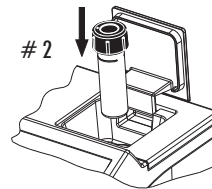

- Press **Read** and the meter will perform the reading. The instrument displays the results in **mg/L** of chlorine dioxide.

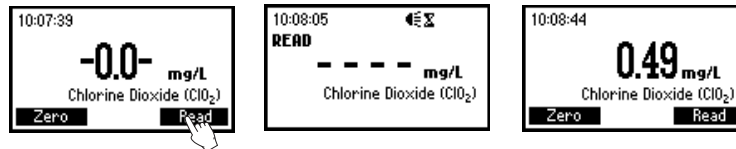

SAMPLING PROCEDURE

It is recommended to analyze chlorine dioxide samples immediately after collection. Chlorine dioxide samples must be stored in sealed dark glass bottle, with minimal head space. Excessive heat (above 25°C/78°F), agitation and exposure to light must be avoided.

INTERFERENCES

Interferences may be caused by strong oxidants.

CHROMIUM VI HIGH RANGE

SPECIFICATIONS

Range	0 to 1000 µg/L
Resolution	1 µg/L
Accuracy	±5 µg/L ±4% of reading at 25 °C
Typical EMC Deviation	±1 µg/L
Light Source	Tungsten lamp with narrow band interference filter @ 525 nm
Method	Adaptation of the <i>ASTM Manual of Water and Environmental Technology, D1687-92</i> , Diphenylcarbohydrazide method. The reaction between chromium VI and the reagent causes a purple tint in the sample.

REQUIRED REAGENTS

<u>Code</u>	<u>Description</u>	<u>Quantity</u>
HI 93723-0	Powder reagent	1 packet

REAGENT SETS

HI 93723-01 Reagents for 100 tests

HI 93723-03 Reagents for 300 tests

For other accessories see page 73.

MEASUREMENT PROCEDURE

- Select the *Chromium VI HR* method using the procedure described in the *Method Selection* section (see page 12).
- Fill the cuvette up to the mark with 10 mL of unreacted sample and replace the cap.
- Place the cuvette into the holder and close the lid.

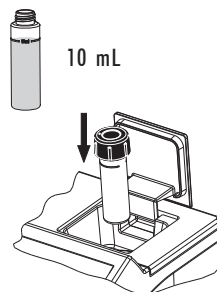

- Press the **Zero** key. The meter will show “-0.0-” when the meter is zeroed and ready for measurement.

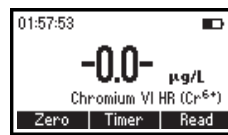
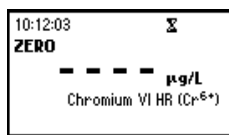
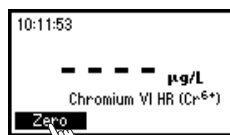

- Remove the cuvette and add the content of one packet of HI 93723-0 reagent. Replace the cap and shake vigorously for about 10 seconds.

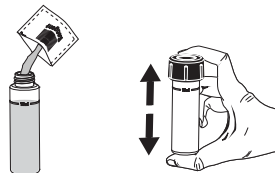

- Reinsert the cuvette into the instrument.

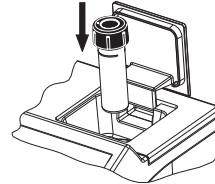

- Press **Timer** and the display will show the countdown prior to the measurement or, alternatively, wait for 6 minutes and press **Read**. When the timer ends the meter will perform the reading. The instrument displays concentration in $\mu\text{g/L}$ of chromium VI.

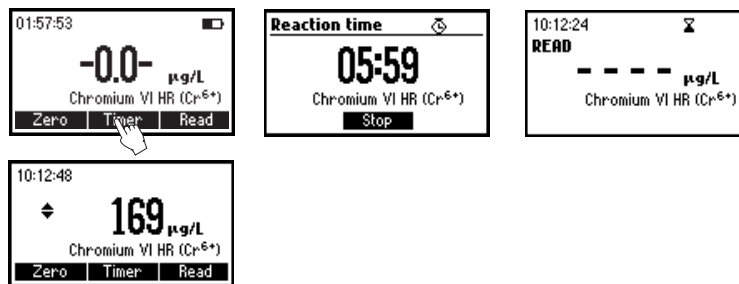

- Press \blacktriangle or \blacktriangledown to access the second level functions.
- Press the **Chem Frm** key to convert the result in $\mu\text{g/L}$ of Chromate (CrO_4^{2-}) and Dichromate ($\text{Cr}_2\text{O}_7^{2-}$).

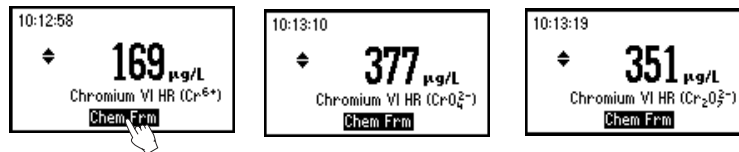

- Press \blacktriangle or \blacktriangledown to return to the measurement screen.

INTERFERENCES

Interference may be caused by:

Vanadium above 1 ppm. However, waiting 10 minutes before reading, the interference is removed

Iron above 1 ppm

Mercurous and mercuric ions cause slight inhibition of the reaction.

CHROMIUM VI LOW RANGE

SPECIFICATIONS

Range	0 to 300 µg/L
Resolution	1 µg/L
Accuracy	±1 µg/L ±4% of reading at 25 °C
Typical EMC Deviation	±1 µg/L
Light Source	Tungsten lamp with narrow band interference filter @ 525 nm
Method	Adaptation of the <i>ASTM Manual of Water and Environmental Technology, D1687-92</i> , Diphenylcarbohydrazide method. The reaction between chromium VI and the reagent causes a purple tint in the sample.

REQUIRED REAGENTS

<u>Code</u>	<u>Description</u>	<u>Quantity</u>
HI 93749-0	Powder reagent	1 packet

REAGENT SETS

HI 93749-01 Reagents for 100 tests

HI 93749-03 Reagents for 300 tests

For other accessories see page 73.

MEASUREMENT PROCEDURE

- Select the *Chromium VI LR* method using the procedure described in the *Method Selection* section (see page 12).
- Fill the cuvette up to the mark with 10 mL of unreacted sample and replace the cap.
- Place the cuvette into the holder and close the lid.
- Press the **Zero** key. The meter will show “-0.0-” when the meter is zeroed and ready for measurement.

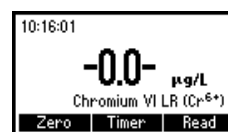
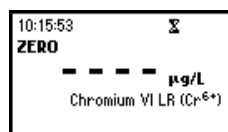
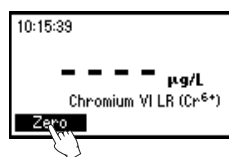
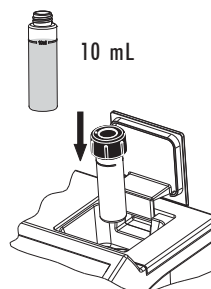

- Remove the cuvette and add the content of one packet of HI 93749-0 reagent. Replace the cap and shake vigorously for about 10 seconds.

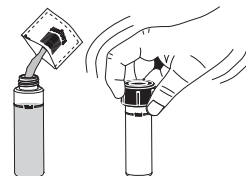

- Reinsert the cuvette into the instrument.

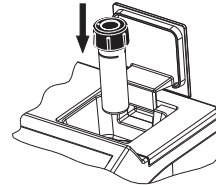

- Press **Timer** and the display will show the countdown prior to the measurement or, alternatively, wait for 6 minutes and press **Read**. When the timer ends the meter will perform the reading. The instrument displays concentration in **µg/L of chromium VI**.

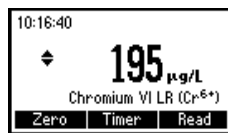
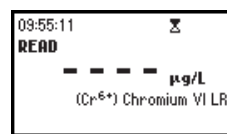
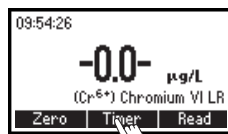

- Press **▲** or **▼** to access the second level functions.
- Press the **Chem Frm** key to convert the result in µg/L of Chromate (CrO_4^{2-}) and Dichromate ($\text{Cr}_2\text{O}_7^{2-}$).

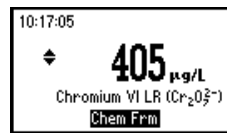
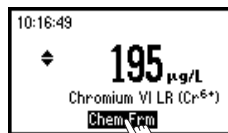

- Press **▲** or **▼** to return to the measurement screen.

INTERFERENCES

Interference may be caused by:

Vanadium above 1 ppm. However, waiting 10 minutes before reading, the interference is removed.

Iron above 1 ppm

Mercurous and mercuric ions cause slight inhibition of the reaction.

COPPER HIGH RANGE

SPECIFICATIONS

Range	0.00 to 5.00 mg/L
Resolution	0.01 mg/L
Accuracy	±0.02 mg/L ±4% of reading at 25 °C
Typical EMC	±0.01 mg/L
Deviation	
Light Source	Tungsten lamp with narrow band interference filter @ 575 nm
Method	Adaptation of the <i>EPA method</i> . The reaction between copper and the bicinchoninate reagent causes a purple tint in the sample.

REQUIRED REAGENTS

<u>Code</u>	<u>Description</u>	<u>Quantity</u>
HI 93702-0	Bicinchoninate	1 packet

REAGENT SETS

HI 93702-01 Reagents for 100 tests

HI 93702-03 Reagents for 300 tests

For other accessories see page 73.

MEASUREMENT PROCEDURE

- Select the *Copper HR* method using the procedure described in the *Method Selection* section (see page 12).
- Fill the cuvette with 10 mL of unreacted sample (up to the mark) and replace the cap.



- Place the cuvette into the holder and close the lid.

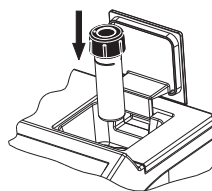

- Press the **Zero** key. The meter will show “-0.0-” when the meter is zeroed and ready for measurement.

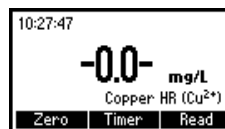
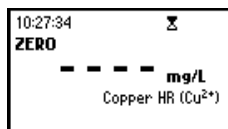
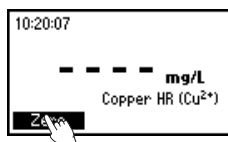

- Remove the cuvette.
- Add the content of one packet of HI 93702-0 Bicinchoninate. Replace the cap and shake gently for about 15 seconds.

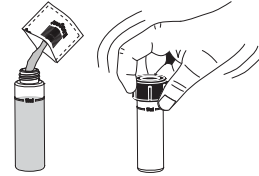

- Reinsert the cuvette into the instrument.

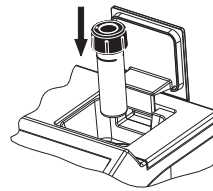

- Press **Timer** and the display will show the countdown prior to the measurement or, alternatively, wait for 45 seconds and press **Read**. When the timer ends the meter will perform the reading.

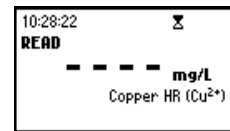
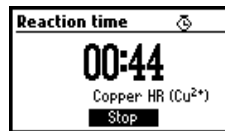
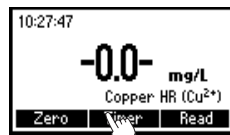

- The instrument displays the results in **mg/L** of copper.



INTERFERENCES

Interference may be caused by:

Silver

Cyanide

For samples overcoming buffering capacity of reagent (around pH 6.8), pH should be adjusted between 6 and 8.

COPPER LOW RANGE

SPECIFICATIONS

Range	0 to 1000 µg/L
Resolution	1 µg/L
Accuracy	±10 µg/L ±5% of reading at 25 °C
Typical EMC	±1 µg/L
Deviation	
Light Source	Tungsten lamp with narrow band interference filter @ 575 nm
Method	Adaptation of the <i>EPA method</i> . The reaction between copper and the bicinchoninate reagent causes a purple tint in the sample.

REQUIRED REAGENTS

<u>Code</u>	<u>Description</u>	<u>Quantity</u>
HI 95747-0	Bicinchoninate	1 packet

REAGENT SETS

HI 95747-01 Reagents for 100 tests

HI 95747-03 Reagents for 300 tests

For other accessories see page 73.

MEASUREMENT PROCEDURE

- Select the *Copper LR* method using the procedure described in the *Method Selection* section (see page 12).
- Fill the cuvette with 10 mL of unreacted sample (up to the mark) and replace the cap.
- Place the cuvette into the holder and close the lid.

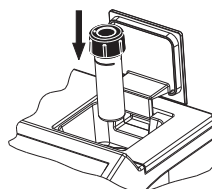

- Press the **Zero** key. The meter will show “-0.0-” when the meter is zeroed and ready for measurement.

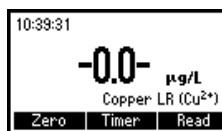
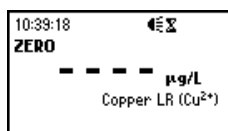
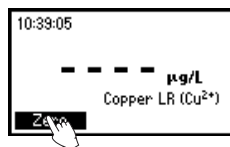

- Remove the cuvette.
- Add the content of one packet of HI 95747-0 Bicinchoninate. Replace the cap and shake gently for about 15 seconds.

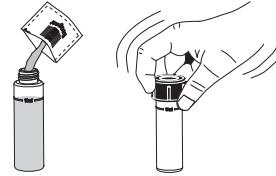

- Reinsert the cuvette into the instrument.

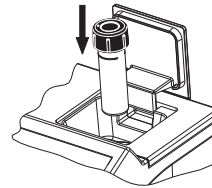

- Press **Timer** and the display will show the countdown prior to the measurement or, alternatively, wait for 45 seconds and press **Read**. When the timer ends the meter will perform the reading.

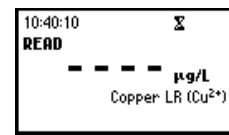
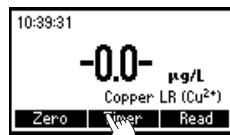

- The instrument displays the results in $\mu\text{g/L}$ of copper.



INTERFERENCES

Interference may be caused by:

Silver

Cyanide

For samples overcoming buffering capacity of reagent (around pH 6.8), pH should be adjusted between 6 and 8.

HYDRAZINE

SPECIFICATIONS

Range	0 to 400 µg/L
Resolution	1 µg/L
Accuracy	±4% of full scale at 25 °C
Typical EMC Deviation	±2 µg/L
Light Source	Tungsten lamp with narrow band interference filter @ 420 nm
Method	Adaptation of the <i>ASTM Manual of Water and Environmental Technology</i> , method D1385-88, p-Dimethylaminobenzaldehyde method. The reaction between hydrazine and the liquid reagent causes a yellow tint in the sample.

REQUIRED REAGENT

<u>Code</u>	<u>Description</u>	<u>Quantity</u>
HI 93704-0	Liquid Reagent	24 drops

REAGENT SETS

HI 93704-01 Reagents for 100 tests

HI 93704-03 Reagents for 300 tests

For other accessories see page 73.

MEASUREMENT PROCEDURE

- Select the *Hydrazine* method using the procedure described in the *Method Selection* section (see page 12).
- Fill one cuvette up to the mark with 10 mL of distilled water.



- Place the cap, insert the cuvette # 1 into the holder and close the lid.

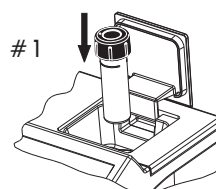

- Press the **Blank** key to start adjusting the light level. The display will show "Blank done" when the meter is ready to take a zero measurement.

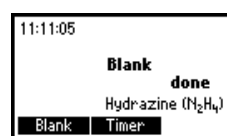
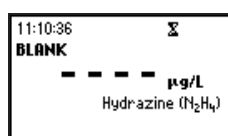
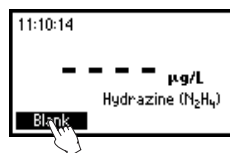

- Fill a second cuvette with 10 mL of unreacted sample (up to the mark) and replace the cap.



- Add 12 drops of the HI 93704-0 reagent to each cuvette. Replace the caps and shake gently to mix (about 30 seconds).

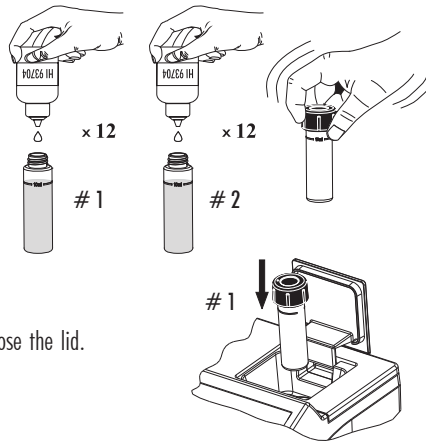

- Place the blank (#1) into the holder and close the lid.

- Press **Timer** and the display will show the countdown prior to zeroing the blank. The display will show “-0.0-” when the meter is zeroed and ready for measurement.

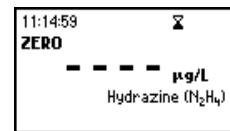
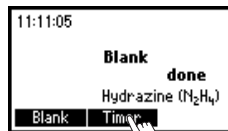

- Remove the blank.
- Insert the cuvette with the reacted sample (# 2) into the instrument and close the lid.

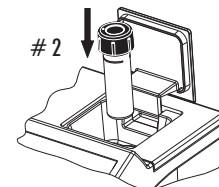

- Press **Read** to start the reading. The instrument displays concentration in $\mu\text{g/L}$ of hydrazine.

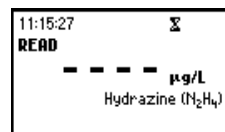
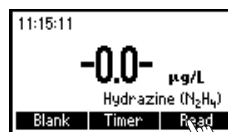

INTERFERENCES

Interference may be caused by:
 Highly colored samples
 Highly turbid samples
 Aromatic amines

IRON HIGH RANGE

SPECIFICATIONS

Range	0.00 to 5.00 mg/L
Resolution	0.01 mg/L
Accuracy	± 0.04 mg/L $\pm 2\%$ of reading at 25 °C
Typical EMC	± 0.01 mg/L
Deviation	
Light Source	Tungsten lamp with narrow band interference filter @ 525 nm
Method	Adaptation of the <i>EPA Phenantroline method 315B</i> , for natural and treated waters. The reaction between iron and reagents causes an orange tint in the sample.

REQUIRED REAGENTS

<u>Code</u>	<u>Description</u>	<u>Quantity</u>
HI 93721-0	Powder Reagent	1 packet

REAGENT SETS

HI 93721-01 Reagents for 100 tests

HI 93721-03 Reagents for 300 tests

For other accessories see page 73.

MEASUREMENT PROCEDURE

- Select the *Iron HR* method using the procedure described in the *Method Selection* section (see page 12).
- Fill the cuvette with 10 mL of unreacted sample (up to the mark) and replace the cap.
- Place the cuvette into the holder and close the lid.
- Press the **Zero** key. The display will show “-0.0-” the meter is zeroed and ready for measurement.

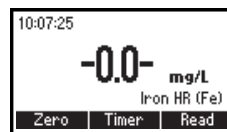
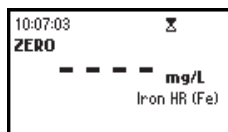
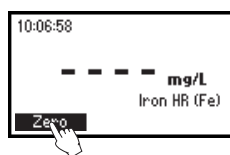
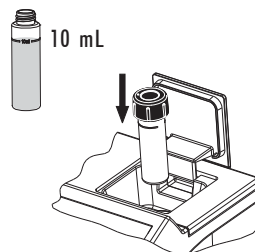

- Remove the cuvette and add the content of one packet of HI 93721-0 reagent. Replace the cap and shake until dissolution is complete.

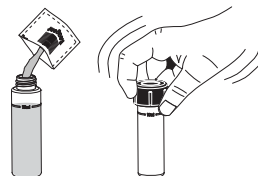

- Reinsert the cuvette into the instrument.

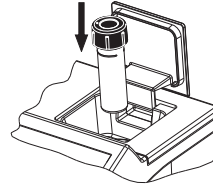

- Press **Timer** and the display will show the countdown prior to the measurement or, alternatively, wait for 3 minutes and press **Read**. When the timer ends the meter will perform the reading.

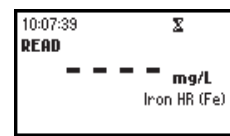

- The instrument displays concentration in **mg/L of iron**.

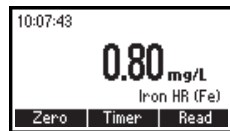

INTERFERENCES

Interference may be caused by:

Molybdate Molybdenum above 50 ppm

Calcium above 10000 ppm (as CaCO₃)

Magnesium above 100000 ppm (as CaCO₃)

Chloride above 185000 ppm.

IRON LOW RANGE

SPECIFICATIONS

Range	0 to 400 $\mu\text{g/L}$
Resolution	1 $\mu\text{g/L}$
Accuracy	$\pm 10 \mu\text{g/L} \pm 8\%$ of reading at 25 °C
Typical EMC	$\pm 1 \mu\text{g/L}$
Deviation	
Light Source	Tungsten lamp with narrow band interference filter @ 575 nm
Method	Adaptation of the TPTZ Method. The reaction between iron and the reagent causes a violet tint in the sample.

REQUIRED REAGENTS

Code	Description	Quantity
HI 93746-0	TPTZ Reagent	2 packets

REAGENT SETS

HI 93746-01 Reagents for 50 tests

HI 93746-03 Reagents for 150 tests

For other accessories see page 73.

MEASUREMENT PROCEDURE

- Select the *Iron LR* method using the procedure described in the *Method Selection* section (see page 12).
- Fill one graduated mixing cylinder up to the 25 mL mark with deionized water.
- Add the content of one packet of HI 93746-0 TPTZ reagent, close the cylinder and shake vigorously for 30 seconds. This is the blank.
- Fill a cuvette with 10 mL of the blank up to the mark and replace the cap.
- Place the cuvette into the holder and close the lid.

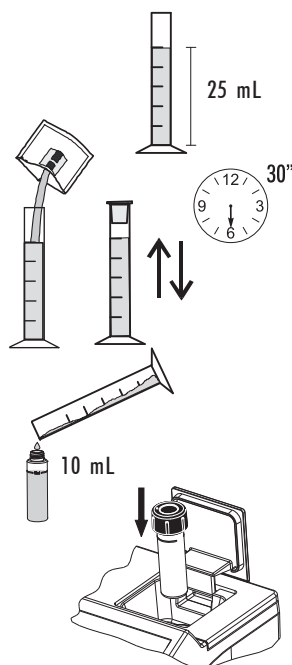

- Press the **Zero** key. The display will show “-0.0-” when the meter is zeroed and ready for measurement.

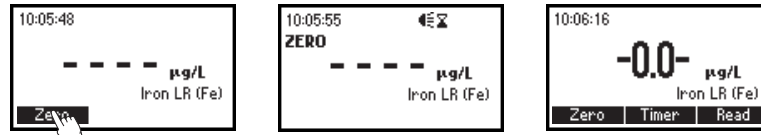

- Remove the cuvette.
- Fill another graduated mixing cylinder up to the 25 mL mark with the sample.
- Add the content of one packet of HI 93746-0 TPTZ reagent, close the cylinder and shake vigorously for 30 seconds. This is the reacted sample.
- Fill a cuvette with 10 mL of the reacted sample up to the mark and replace the cap.
- Insert the sample into the instrument.

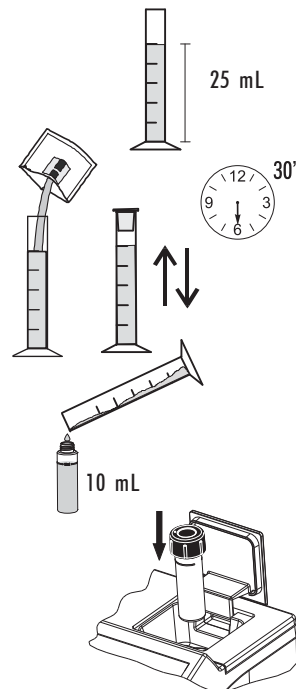

- Press **Timer** and the display will show the countdown prior to the measurement or, alternatively, wait for 30 seconds and press **Read**. When the timer ends the meter will perform the reading. The instrument displays concentration in $\mu\text{g/L}$ of iron.

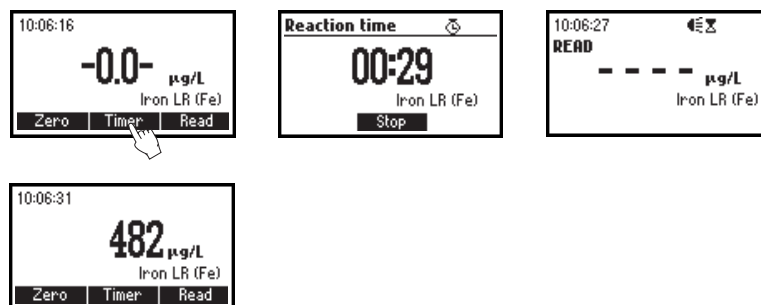

INTERFERENCES

Interference may be caused by:

Cadmium above 4.0 mg/L

Chromium³⁺ above 0.25 mg/L

Chromium⁶⁺ above 1.2 mg/L

Cobalt above 0.05 mg/L

Copper above 0.6 mg/L

Cyanide above 2.8 mg/L

Manganese above 50.0 mg/L

Mercury above 0.4 mg/L

Molybdenum above 4.0 mg/L

Nickel above 1.0 mg/L

Nitrite ion above 0.8 mg/L

Sample pH should be between 3 and 4 to avoid developed color to fade or turbidity formation.

MOLYBDENUM

SPECIFICATIONS

Range	0.0 to 40.0 mg/L
Resolution	0.1 mg/L
Accuracy	± 0.3 mg/L $\pm 5\%$ of reading at 25 °C
Typical EMC	± 0.1 mg/L
Deviation	
Light Source	Tungsten lamp with narrow band interference filter @ 420 nm
Method	Adaptation of the mercaptoacetic acid method. The reaction between molybdenum and the reagents causes a yellow tint in the sample.

REQUIRED REAGENT

<u>Code</u>	<u>Description</u>	<u>Quantity</u>
HI 93730A-0	Reagent A	1 packet
HI 93730B-0	Reagent B	1 packet
HI 93730C-0	Reagent C	1 packet

REAGENT SETS

HI 93730-01 Reagents for 100 tests

HI 93730-03 Reagents for 300 tests

For other accessories see page 73.

MEASUREMENT PROCEDURE

- Select the *Molybdenum* method using the procedure described in the *Method Selection* section (see page 12).
- Fill the cuvette with 10 mL of unreacted sample (up to the mark) and replace the cap.
- Place the cuvette into the holder and close the lid.

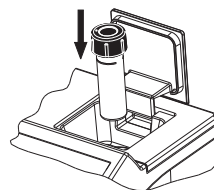

- Press the **Zero** key. The display will show “-0.0-” when the meter is zeroed and ready for measurement.

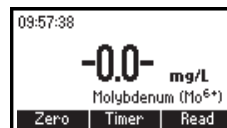
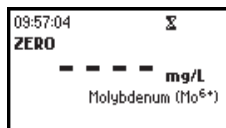
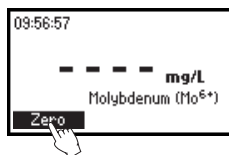

- Fill one graduated mixing cylinder up to the 25 mL mark with the sample.

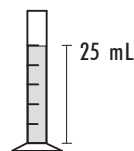

- Add the content of one packet of HI 93730A-0 molybdenum reagent, close the cylinder and invert it several times until completely dissolved.

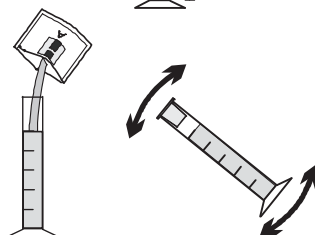

- Add the content of one packet of HI 93730B-0 molybdenum reagent to the cylinder, close and invert it several times until completely dissolved.

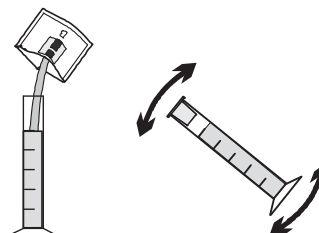

- Add the content of one packet of HI 93730C molybdenum reagent to the cylinder, close and shake it vigorously.

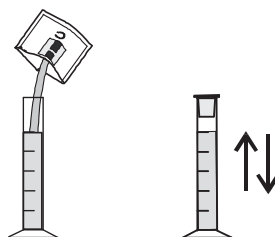

- Fill an empty cuvette with 10 mL of sample up to the mark and replace the cap.

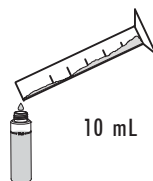

- Insert the cuvette into the instrument.

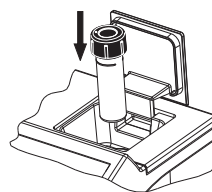

- Press **Timer** and the display will show the countdown prior to the measurement or, alternatively, wait for five minutes and press **Read**. When the timer ends the meter will perform the reading. The instrument displays concentration in **mg/L of molybdenum**.

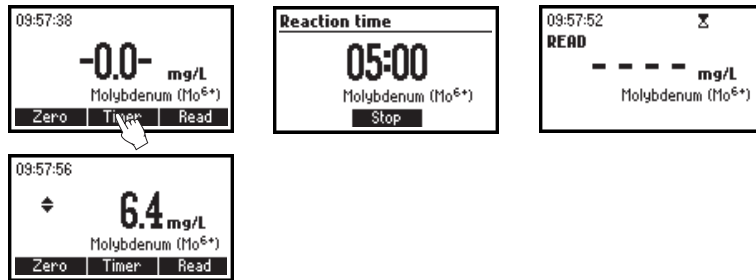

- Press **▲** or **▼** to access the second level functions.
- Press the **Chem Frm** key to convert the result in mg/L of molybdate (MoO_4) and sodium molybdate (Na_2MoO_4).

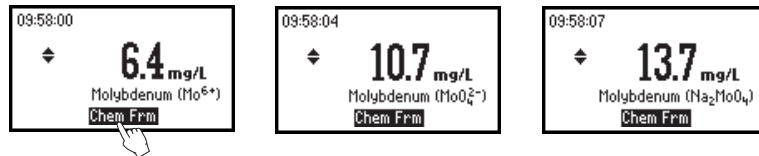

- Press **▲** or **▼** to return to the measurement screen.

INTERFERENCES

Interference may be caused by:

Aluminum above 50 mg/L

Chromium above 1000 mg/L

Copper above 10 mg/L

Iron above 50 mg/L

Nickel above 50 mg/L

Nitrite, as NO_2^-

Sulfate above 200 mg/L

Highly buffered samples or with extreme pH may exceed the buffering capacity of the reagents.

NITRATE

SPECIFICATIONS

Range	0.0 to 30.0 mg/L
Resolution	0.1 mg/L
Accuracy	± 0.5 mg/L $\pm 10\%$ of reading at 25 °C
Typical EMC	± 0.1 mg/L
Deviation	
Light Source	Tungsten lamp with narrow band interference filter @ 525 nm
Method	Adaptation of the cadmium reduction method. The reaction between nitrate and the reagent causes an amber tint in the sample.

REQUIRED REAGENTS

Code	Description	Quantity
HI 93728-0	Powder reagent	1 packet

REAGENT SETS

HI 93728-01 Reagents for 100 tests

HI 93728-03 Reagents for 300 tests

For other accessories see page 73.

MEASUREMENT PROCEDURE

- Select the *Nitrate* method using the procedure described in the *Method Selection* section (see page 12).
- Using the pipette, fill the cuvette with 6 ml of sample, up to half of its height, and replace the cap.
- Place the cuvette into the holder and close the lid.
- Press the **Zero** key. The display will show “-0.0-” when the meter is zeroed and ready for measurement.

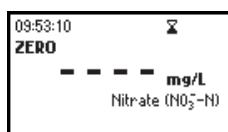
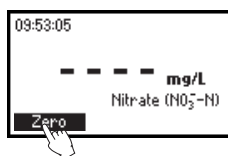
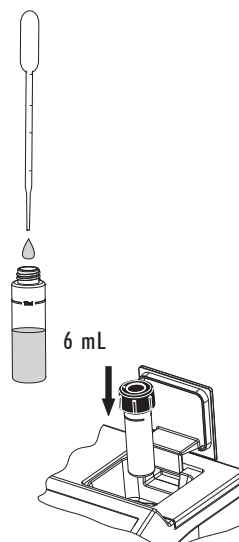

- Remove the cuvette and add the content of one packet of HI 93728-0 reagent.



- Replace the cap and immediately shake vigorously up and down for exactly 10 seconds. Continue to mix by inverting the cuvette gently for 50 seconds, while taking care not to induce air bubbles. Powder will not completely dissolve. Time and way of shaking could sensitively affect the measurement.
- Reinsert the cuvette into the instrument, taking care not to shake it.
- Press **Timer** and the display will show the countdown prior to the measurement or, alternatively, wait for 4 minutes and 30 seconds and press **Read**. When the timer ends the meter will perform the reading. The instrument displays the results in **mg/L of nitrate-nitrogen**.

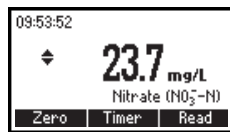
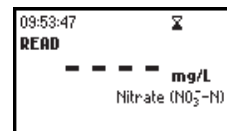
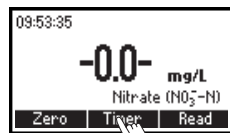
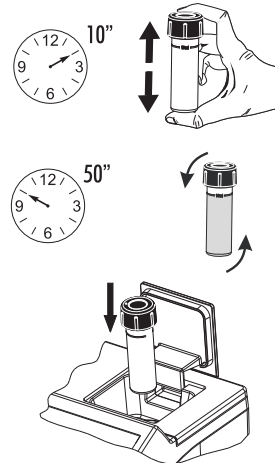

- Press **▲** or **▼** to access the second level functions.
- Press the **Chem Frm** key to convert the result in mg/L of nitrate (NO_3^-).

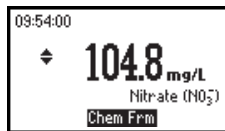

- Press **▲** or **▼** to return to the measurement screen.

INTERFERENCES

Interference may be caused by:

Ammonia and amines, as urea and primary aliphatic amines

Chloride above 100 ppm

Chlorine above 2 ppm

Copper

Iron(III)

Strong oxidizing and reducing substances

Sulfide must be absent

NITRITE HIGH RANGE

SPECIFICATIONS

Range	0 to 150 mg/L
Resolution	1 mg/L
Accuracy	± 4 mg/L $\pm 4\%$ of reading at 25 °C
Typical EMC	± 1 mg/L
Deviation	
Light Source	Tungsten lamp with narrow band interference filter @ 575 nm
Method	Adaptation of the Ferrous Sulfate method. The reaction between nitrite and the reagent causes a greenish-brown tint in the sample.

REQUIRED REAGENTS

<u>Code</u>	<u>Description</u>	<u>Quantity</u>
HI 93708-0	Powder reagent	1 packet

REAGENT SETS

HI 93708-01 Reagents for 100 tests

HI 93708-03 Reagents for 300 tests

For other accessories see page 73.

MEASUREMENT PROCEDURE

- Select the *Nitrite HR* method using the procedure described in the *Method Selection* section (see page 12).
- Fill the cuvette up to the mark with 10 mL of unreacted sample and replace the cap.
- Place the cuvette into the holder and close the lid.

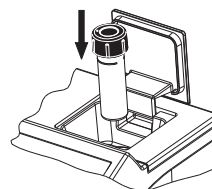

- Press the **Zero** key. The display will show “-0.0-” when the meter is zeroed and ready for measurement.

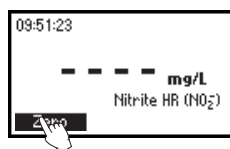

- Remove the cuvette.

- Add the content of one packet of HI 93708-0 reagent. Replace the cap and shake gently until completely dissolved.

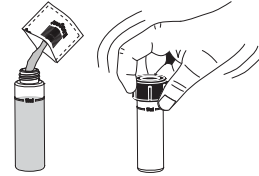

- Reinsert the cuvette into the instrument.

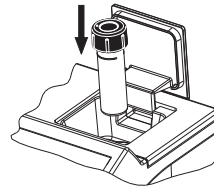

- Press **Timer** and the display will show the countdown prior to the measurement or, alternatively, wait for 10 minutes and press **Read**. When the timer ends the meter will perform the reading. The instrument displays concentration in **mg/L of nitrite**.

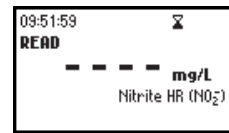

- Press **▲** or **▼** to access the second level functions.
- Press the **Chem Frm** key to convert the result in mg/L of nitrogen-nitrite (NO_2^- -N) and sodium nitrite (NaNO_2).

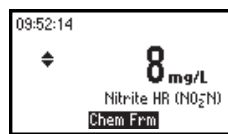

- Press **▲** or **▼** to return to the measurement screen.

NITRITE LOW RANGE

SPECIFICATIONS

Range	0.00 to 1.15 mg/L
Resolution	0.01 mg/L
Accuracy	± 0.06 mg/L $\pm 4\%$ of reading at 25 °C
Typical EMC Deviation	± 0.01 mg/L
Light Source	Tungsten lamp with narrow band interference filter @ 525 nm
Method	Adaptation of the <i>EPA Diazotization method 354.1</i> . The reaction between nitrite and the reagent causes a pink tint in the sample.

REQUIRED REAGENTS

<u>Code</u>	<u>Description</u>	<u>Quantity</u>
HI 93707-0	Powder reagent	1 packet

REAGENT SETS

HI 93707-01 Reagents for 100 tests

HI 93707-03 Reagents for 300 tests

For other accessories see page 73.

MEASUREMENT PROCEDURE

- Select the *Nitrite LR* method using the procedure described in the *Method Selection* section (see page 12).
- Fill the cuvette up to the mark with 10 mL of unreacted sample (up to the mark) and replace the cap.
- Place the cuvette into the holder and close the lid.
- Press the **Zero** key. The display will show “-0.0-” when the meter is zeroed and ready for measurement.

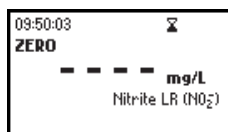
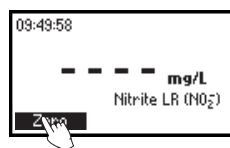
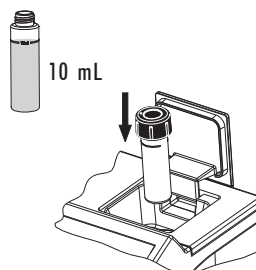

- Remove the cuvette.
- Add the content of one packet of HI 93707-0 reagent. Replace the cap and shake gently for about 15 seconds.

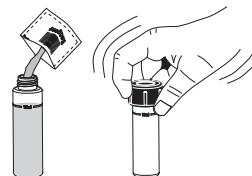

- Reinsert the cuvette into the instrument.

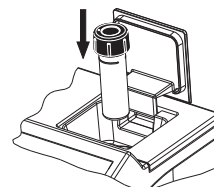

- Press **Timer** and the display will show the countdown prior to the measurement or, alternatively, wait for 6 minutes and press **Read**. When the timer ends the meter will perform the reading. The instrument displays concentration in **mg/L of nitrite**.

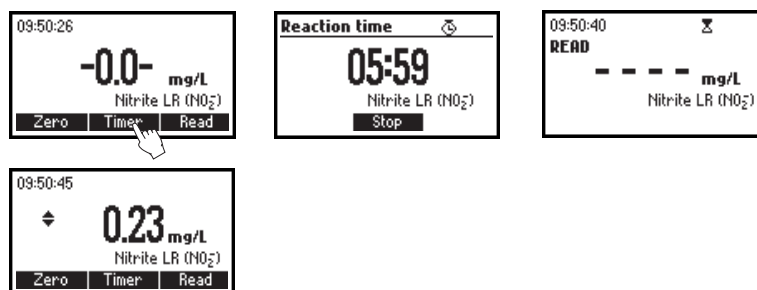

- Press **▲** or **▼** to access the second level functions.
- Press the **Chem Frm** key to convert the result in mg/L of nitrogen-nitrite ($\text{NO}_2^- \text{-N}$) and sodium nitrite (NaNO_2).



- Press **▲** or **▼** to return to the measurement screen.

INTERFERENCES

Interference may be caused by the following ions:

ferrous, ferric, cupric, mercurous, silver, antimonious, bismuth, auric, lead, metavanadate and chloroplatinate.

Strongly reducing and oxidizing reagents.

High levels of nitrate (above 100 mg/L) could yield falsely high readings due to a minute amount of reduction to nitrite that could occur at these levels.

DISSOLVED OXYGEN

SPECIFICATIONS

Range	0.0 to 10.0 mg/L
Resolution	0.1 mg/L
Accuracy	± 0.4 mg/L $\pm 3\%$ of reading at 25 °C
Typical EMC	± 0.1 mg/L
Deviation	
Light Source	Tungsten lamp with narrow band interference filter @ 420 nm
Method	Adaptation of the <i>Standard Methods for the Examination of Water and Wastewater, 18th edition</i> , Azide modified Winkler method. The reaction between dissolved oxygen and the reagents causes a yellow tint in the sample.

REQUIRED REAGENTS

Code	Description	Quantity
HI 93732A-0	Reagent A	5 drops
HI 93732B-0	Reagent B	5 drops
HI 93732C-0	Reagent C	10 drops

REAGENT SET

HI 93732-01 Reagents for 100 tests

HI 93732-03 Reagents for 300 tests

For other accessories see page 73.

MEASUREMENT PROCEDURE

- Select the *Dissolved Oxygen* method using the procedure described in the *Method Selection* section (see page 12).
- Fill one 60 mL glass bottle completely with the unreacted sample.
- Replace the cap and ensure that a small part of the sample spills over.
- Remove the cap and add 5 drops of HI 93732A-0 and 5 drops of HI 93732B-0.
- Add more sample, to fill the bottle completely. Replace the cap again and ensure that a part of the sample spills over. This is to make sure that no air bubbles have been trapped inside, which could alter the reading.
- Invert several times the bottle. The sample becomes orange-yellow and a flocculent agent will appear.

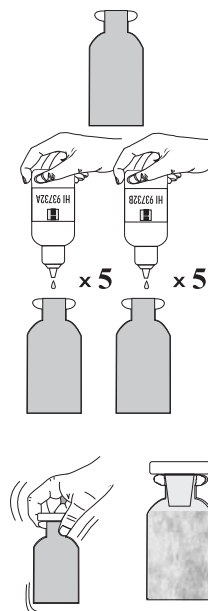

- Let the sample stand and the flocculent agent will start to settle.
- After approximately 2 minutes, when the upper half of the bottle becomes limpid, add 10 drops of HI 93732C-0.
- Replace the cap and invert the bottle until the settled flocculent dissolves completely. The sample is ready for measurement when it is yellow and completely limpid.

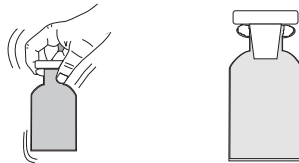

- Fill the cuvette up to the mark with 10 mL of the unreacted (original) sample, and replace the cap. This is the blank.
- Place the cuvette into the holder and close the lid.

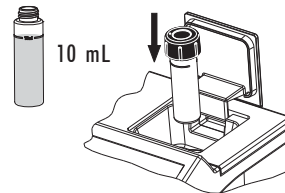

- Press the **Zero** key. The display will show “-0.0-” when the meter is zeroed and ready for measurement.

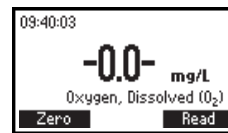
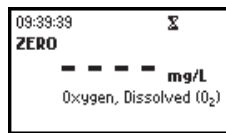
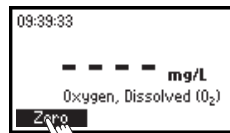

- Remove the cuvette.
- Fill another cuvette up to the mark with 10 mL of the reacted sample and replace the cap.
- Reinsert the cuvette into the instrument.
- Press **Read** to start the reading. The instrument will display the results in **mg/L of dissolved oxygen**.

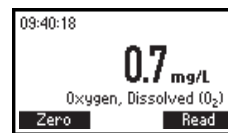
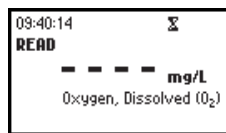
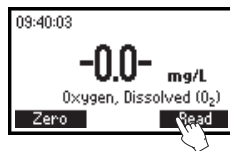

INTERFERENCES

Interferences may be caused by reducing and oxidizing materials.

pH

SPECIFICATIONS

Range	6.5 to 8.5 pH
Resolution	0.1 pH
Accuracy	± 0.1 pH at 25 °C
Typical EMC	± 0.1 pH
Deviation	
Light Source	Tungsten lamp with narrow band interference filter @ 525 nm
Method	Adaptation of the Phenol Red method. The reaction with the reagent causes a yellow to red tint in the sample.

REQUIRED REAGENTS

Code	Description	Quantity
HI 93710-0	Phenol Red Indicator	5 drops

REAGENT SETS

HI 93710-01 Reagents for 100 pH tests

HI 93710-03 Reagents for 300 pH tests

For other accessories see page 73.

MEASUREMENT PROCEDURE

- Select the *pH* method using the procedure described in the *Method Selection* section (see page 12).
- Fill the cuvette with 10 mL of unreacted sample (up to the mark) and replace the cap.
- Place the cuvette into the holder and close the lid.
- Press the **Zero** key. The display will show “-0.0-” when the meter is zeroed and ready for measurement.

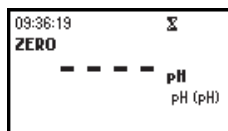
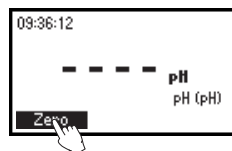
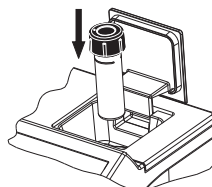

- Remove the cuvette and add 5 drops of HI 93710-0 Phenol Red Indicator. Replace the cap and mix the solution.

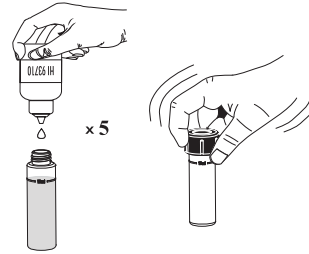

- Reinsert the cuvette into the instrument.

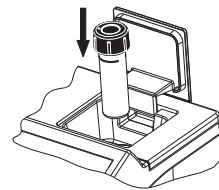

- Press the **Read** key to start the reading. The instrument displays the **pH value**.

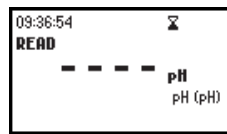

PHOSPHATE HIGH RANGE

SPECIFICATIONS

Range	0.0 to 30.0 mg/L
Resolution	0.1 mg/L
Accuracy	±1 mg/L ±4% of reading at 25 °C
Typical EMC Dev.	±0.1 mg/L
Light Source	Tungsten lamp with narrow band interference filter @ 525 nm
Method	Adaptation of the <i>Standard Methods for the Examination of Water and Wastewater, 18th edition</i> , Amino Acid method. The reaction between phosphate and reagents causes a blue tint in the sample.

REQUIRED REAGENTS

<u>Code</u>	<u>Description</u>	<u>Quantity</u>
HI 93717A-0	Molybdate	10 drops
HI 93717B-0	Reagent B	1 packet

REAGENT SETS

HI 93717-01 Reagents for 100 tests

HI 93717-03 Reagents for 300 tests

For other accessories see page 73.

MEASUREMENT PROCEDURE

- Select the *Phosphate HR* method using the procedure described in the *Method Selection* section (see page 12).
- Fill the cuvette with 10 mL of unreacted sample (up to the mark) and replace the cap.
- Place the cuvette into the holder and close the lid.
- Press the **Zero** key. The display will show “-0.0-” when the meter is zeroed and ready for measurement.

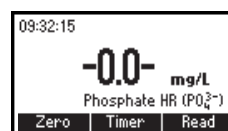
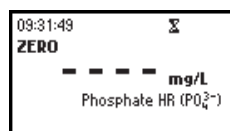
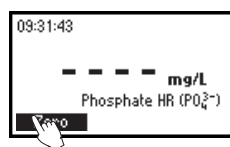
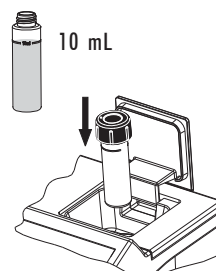

- Remove the cuvette.
- Add 10 drops of HI 93717A-0 Molybdate reagent.



- Add the content of one packet of HI 93717B-0 Phosphate HR Reagent B to the cuvette. Replace the cap and shake gently until completely dissolved.

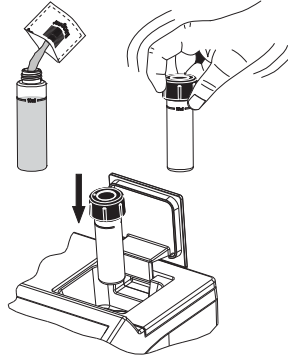

- Reinsert the cuvette into the instrument.

- Press **Timer** and the display will show the countdown prior to the measurement or, alternatively, wait for 5 minutes and press **Read**. When the timer ends the meter will perform the reading. The instrument displays the results in mg/L of phosphate (PO_4^{3-}).

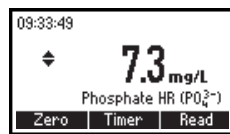
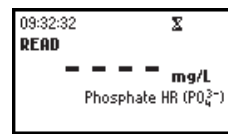
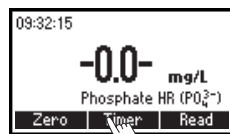

- Press **▲** or **▼** to access the second level functions.
- Press the **Chem Frm** key to convert the result in mg/L of phosphorus (P) and phosphorus pentoxide (P_2O_5).

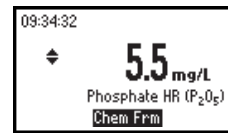
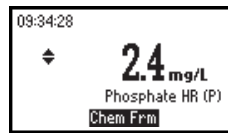
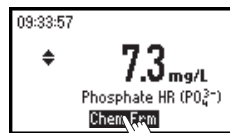

- Press **▲** or **▼** to return to the measurement screen.

INTERFERENCES

Sulfide

Chloride above 150000 mg/L)

Calcium above 10000 mg/L as CaCO_3

Magnesium above 40000 mg/L as CaCO_3

Ferrous iron above 100 mg/L

PHOSPHATE LOW RANGE

SPECIFICATIONS

Range	0.00 to 2.50 mg/L
Resolution	0.01 mg/L
Accuracy	±0.04 mg/L ±4% of reading at 25 °C
Typical EMC Dev.	±0.01 mg/L
Light Source	Tungsten lamp with narrow band interference filter @ 610 nm
Method	Adaptation of the Ascorbic Acid method. The reaction between phosphate and the reagent causes a blue tint in the sample.

REQUIRED REAGENTS

<u>Code</u>	<u>Description</u>	<u>Quantity</u>
HI 93713-0	Powder reagent	1 packet

REAGENT SETS

HI 93713-01 Reagents for 100 tests

HI 93713-03 Reagents for 300 tests

For other accessories see page 73.

MEASUREMENT PROCEDURE

- Select the *Phosphate LR* method using the procedure described in the *Method Selection* section (see page 12).
- Rinse, cap and shake the cuvette several times with unreacted sample. Fill the cuvette with 10 mL of sample up to the mark and replace the cap.
- Place the cuvette into the holder and close the lid.

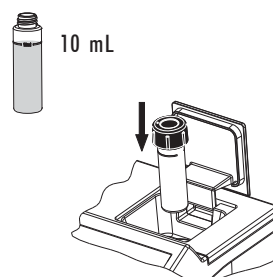

- Press the **Zero** key. The display will show “-0.0-” when the meter is zeroed and ready for measurement.

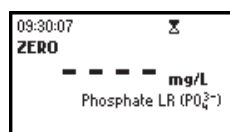
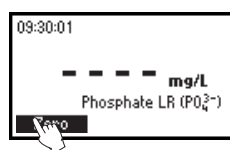

- Remove the cuvette and add the content of one packet of HI 93713-0 reagent. Replace the cap and shake gently (for about 2 minutes) until the powder is completely dissolved.

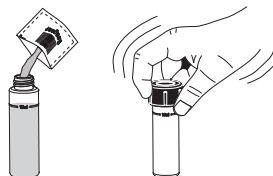

- Reinsert the cuvette into the instrument.

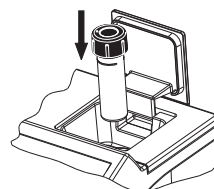

- Press **Timer** and the display will show the countdown prior to the measurement or, alternatively, wait for 3 minutes and press **Read**. When the timer ends the meter will perform the reading. The instrument displays concentration in **mg/L of phosphate (PO_4^{3-})**.

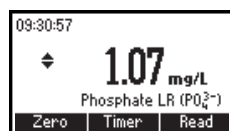
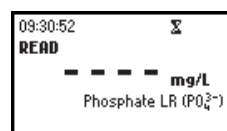
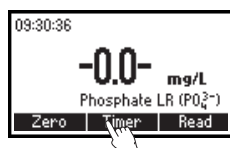

- Press **▲** or **▼** to access the second level functions.
- Press the **Chem Frm** key to convert the result in mg/L of phosphorus (P) and phosphorus pentoxide (P_2O_5).

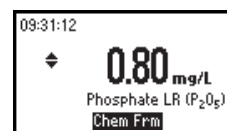
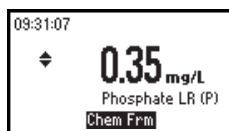
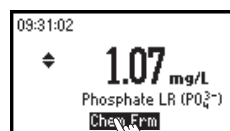

- Press **▲** or **▼** to return to the measurement screen.

INTERFERENCES

Interference may be caused by:

Iron above 50 mg/L

Silica above 50 mg/L

Silicate above 10 mg/L

Copper above 10 mg/L

Hydrogen sulfide, arsenate, turbid sample and highly buffered samples also interfere.

SILICA

SPECIFICATIONS

Range	0.00 to 2.00 mg/L
Resolution	0.01 mg/L
Accuracy	± 0.03 mg/L $\pm 3\%$ of reading at 25 °C
Typical EMC Deviation	± 0.01 mg/L
Light Source	Tungsten lamp with narrow band interference filter @ 610 nm
Method	Adaptation of the <i>ASTM Manual of Water and Environmental Technology, D859</i> , Heteropoly Blue method. The reaction between silica and reagents causes a blue tint in the sample.

REQUIRED REAGENTS

Code	Description	Quantity
HI 93705A-0	Molybdate	6 drops
HI 93705B-0	Citric acid	1 packet
HI 93705C-0	Amino acid	1 packet

REAGENT SETS

HI 93705-01 Reagents for 100 tests

HI 93705-03 Reagents for 300 tests

For other accessories see page 73.

MEASUREMENT PROCEDURE

- Select the *Silica* method using the procedure described in the *Method Selection* section (see page 12).
- Fill the cuvette with 10 mL of unreacted sample (up to the mark).
- Add 6 drops of HI 93705A-0 Molybdate reagent. Replace the cap and swirl the solution.
- Wait for 4 minutes, add the content of one packet of HI 93705B-0 Citric acid reagent and shake until it is completely dissolved.
- Wait for 1 minute. This is the blank.

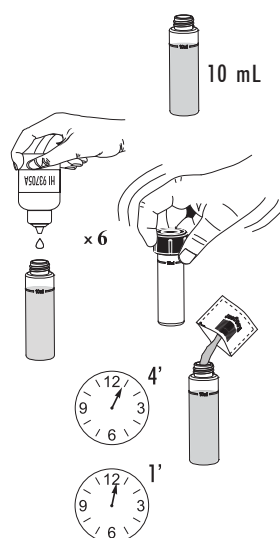

- Place the cuvette into the holder and close the lid.
- Press the **Zero** key. The display will show “-0.0-” when the meter is zeroed and ready for measurement.

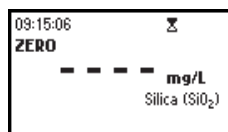
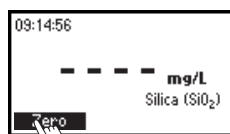
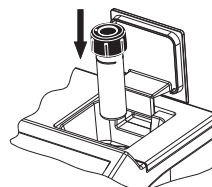

- Remove the cuvette and add the content of one packet of HI 93705C-0 Amino acid reagent and shake until it is completely dissolved.

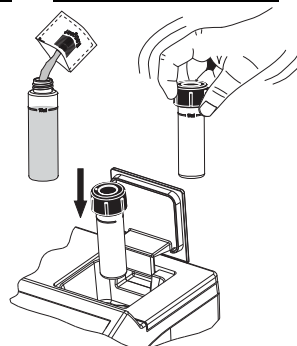

- Reinsert the cuvette into the instrument.

- Press **Timer** and the display will show the countdown prior to the measurement. Alternatively, wait for exactly 3 minutes and press **Read**. When the timer ends the meter will perform the reading. The instrument displays concentration in **mg/L of silica (SiO₂)**.

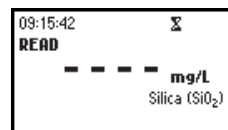
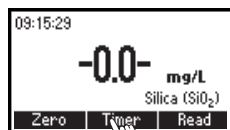

- Press **▲** or **▼** to access the second level functions.
- Press the **Chem Frm** key to convert the result in mg/L of Silicon (Si).

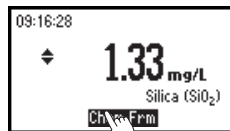

- Press **▲** or **▼** to return to the measurement screen.

INTERFERENCES

Interference may be caused by:

Phosphate above 60 mg/L

Phosphate above 75 mg/L

Sulfide and high concentration of iron

Eliminate color and turbidity interferences by zeroing the meter with the original water sample.

ZINC

SPECIFICATIONS

Range	0.00 to 3.00 mg/L
Resolution	0.01 mg/L
Accuracy	± 0.03 mg/L $\pm 3\%$ of reading at 25 °C
Typical EMC	± 0.01 mg/L
Deviation	
Light Source	Tungsten lamp with narrow band interference filter @ 575 nm
Method	Adaptation of the <i>Standard Methods for the Examination of Water and Wastewater, 18th edition</i> , Zincon method. The reaction between zinc and the reagents causes an orange to a dark violet tint in the sample.

REQUIRED REAGENT

Code	Description	Quantity
HI 93731A-0	Zinc Reagent	1 packet
HI 93731B-0	Cyclohexanone	0.5 mL

REAGENT SETS

HI 93731-01 Reagents for 100 tests

HI 93731-03 Reagents for 300 tests

For other accessories see page 73.

MEASUREMENT PROCEDURE

- Select the *Zinc* method using the procedure described in the *Method Selection* section (see page 12).
- Fill one graduated mixing cylinder up to the 20 mL mark with the sample.
- Add the content of one packet of HI 93731A-0 zinc reagent, close the cylinder and invert several times to mix until completely dissolved.
- Fill one cuvette with 10 mL of the reacted sample up to the mark.

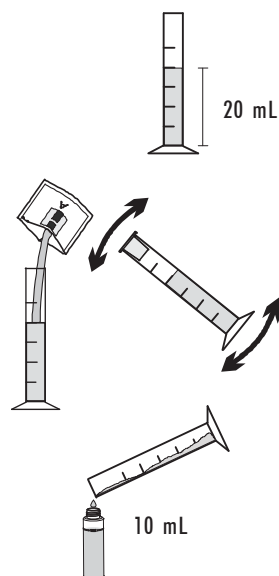

- Place the cap and insert the cuvette into the instrument and close the lid.
- Press the **Zero** key. The display will show “-0.0-” when the meter is zeroed and ready for measurement.

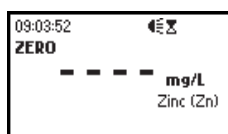
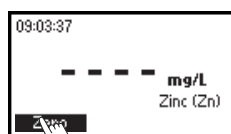
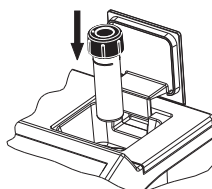

- Remove the cuvette and add 0.5 mL of HI 93731B-0 cyclohexanone to the cuvette.

Note: To prevent any contamination from the polycarbonate cap, prior to replacing it, close the sample cuvette with the supplied HDPE plastic stopper.

- Replace the cap and mix the sample for 15 seconds.

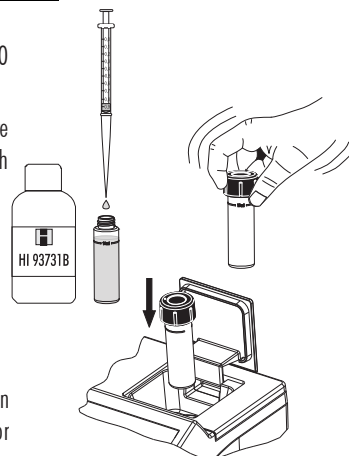

- Insert the sample into the instrument.
- Press **Timer** and the display will show the countdown prior to the measurement or, alternatively, wait for 3 minutes and 30 seconds and press **Read**. When the timer ends the meter will perform the reading.

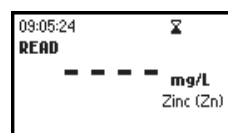
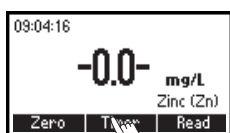

- The instrument displays the results in mg/L of zinc.



INTERFERENCES

Interference may be caused by:
 Aluminum above 6 mg/L
 Cadmium above 0.5 mg/L
 Copper above 5 mg/L
 Iron above 7 mg/L
 Manganese above 5 mg/L
 Nickel above 5 mg/L

ERRORS AND WARNINGS

The instrument shows clear warning messages when erroneous conditions appear and when measured values are outside the expected range. These messages are described below.



No Light: The light source is not functioning properly.



Light Leak: There is an excess amount of ambient light reaching the detector.



Inverted cuvettes: The sample and the zero cuvettes are inverted.



Battery Low: The battery capacity is lower than 10%.



Light Low: The instrument cannot adjust the light level. Please check that the sample does not contain any debris.



Light High: There is too much light to perform a measurement. Please check the preparation of the zero cuvette.

DATA MANAGEMENT

The analyzed data can be managed using Hanna's product HI92000, Windows® Compatible Software.

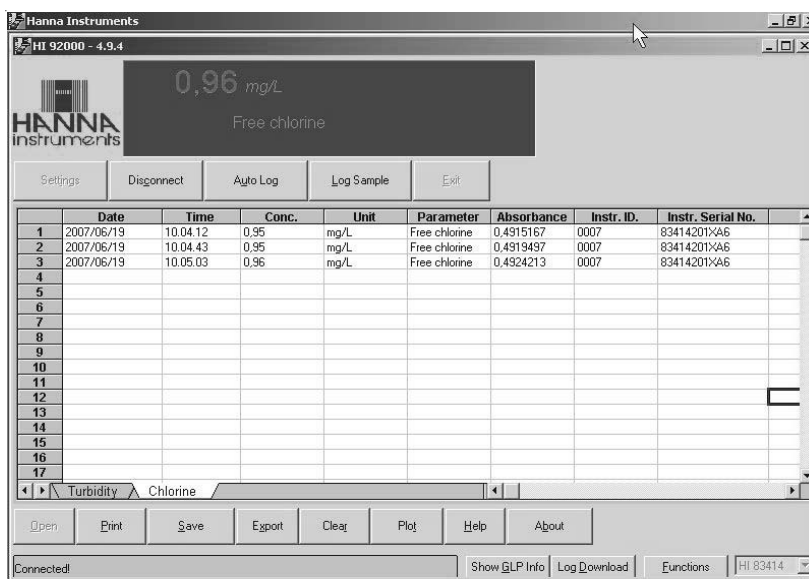

STANDARD METHODS

Description	Range	Method
Aluminum	0.00 to 1.00 mg/L	Aluminon
Ammonia MR	0.00 to 10.00 mg/L	Nessler
Ammonia LR	0.00 to 3.00 mg/L	Nessler
Bromine	0.00 to 8.00 mg/L	DPD
Chlorine, Free	0.00 to 2.50 mg/L	DPD
Chlorine, Total	0.00 to 3.50 mg/L	DPD
Chlorine Dioxide	0.00 to 2.00 mg/L	Chlorophenol Red
Chromium VI HR	0 to 1000 µg/L	Diphenylcarbohydrazide
Chromium VI LR	0 to 300 µg/L	Diphenylcarbohydrazide
Copper HR	0.00 to 5.00 mg/L	Bicinchoninate
Copper LR	0 to 1000 µg/L	Bicinchoninate
Hydrazine	0 to 400 µg/L	p-Dimethylaminobenzaldehyde
Iron HR	0.00 to 5.00 mg/L	Phenantroline
Iron LR	0 to 400 µg/L	TPTZ

Windows® is registered Trademark of "Microsoft Co."

Molybdenum	0.0 to 40.0 mg/L	Mercaptoacetic Acid
Nitrate	0.0 to 30.0 mg/L	Cadmium Reduction
Nitrite HR	0 to 150 mg/L	Ferrous Sulfate
Nitrite LR	0.00 to 1.15 mg/L	Diazotization
Oxygen, Dissolved	0.0 to 10.0 mg/L	Winkler
pH	6.5 to 8.5 pH	Phenol Red
Phosphate HR	0.0 to 30.0 mg/L	Amino Acid
Phosphate LR	0.00 to 2.50 mg/L	Ascorbic Acid
Silica	0.00 to 2.00 mg/L	Heteropoly Blue
Zinc	0.00 to 3.00 mg/L	Zincon

ACCESSORIES

REAGENT SETS

HI 93700-01	100 ammonia LR tests
HI 93700-03	300 ammonia LR tests
HI 93701-01	100 free chlorine tests (powder)
HI 93701-03	300 free chlorine tests (powder)
HI 93701-F	300 free chlorine tests (liquid)
HI 93701-T	300 total chlorine tests (liquid)
HI 93702-01	100 copper HR tests
HI 93702-03	300 copper HR tests
HI 93704-01	100 hydrazine tests
HI 93704-03	300 hydrazine tests
HI 93705-01	100 silica tests
HI 93705-03	300 silica tests
HI 93707-01	100 nitrite LR tests
HI 93707-03	300 nitrite LR tests
HI 93708-01	100 nitrite HR tests
HI 93708-03	300 nitrite HR tests
HI 93710-01	100 pH tests
HI 93710-03	300 pH tests
HI 93711-01	100 total chlorine tests (powder)
HI 93711-03	300 total chlorine tests (powder)
HI 93712-01	100 aluminum tests
HI 93712-03	300 aluminum tests
HI 93713-01	100 phosphate LR tests
HI 93713-03	300 phosphate LR tests
HI 93715-01	100 ammonia MR tests
HI 93715-03	300 ammonia MR tests
HI 93716-01	100 bromine tests
HI 93716-03	300 bromine tests

HI 93717-01	100 phosphate HR tests
HI 93717-03	300 phosphate HR tests
HI 93721-01	100 iron HR tests
HI 93721-03	300 iron HR tests
HI 93723-01	100 chromium VI HR tests
HI 93723-03	300 chromium VI HR tests
HI 93728-01	100 nitrate tests
HI 93728-03	300 nitrate tests
HI 93730-01	100 molybdenum tests
HI 93730-03	300 molybdenum tests
HI 93731-01	100 zinc tests
HI 93731-03	300 zinc tests
HI 93732-01	100 dissolved oxygen tests
HI 93732-03	300 dissolved oxygen tests
HI 93746-01	50 iron LR tests
HI 93746-03	150 iron LR tests
HI 93749-01	100 chromium VI LR tests
HI 93749-03	300 chromium VI LR tests
HI 95747-01	100 copper LR tests
HI 95747-03	300 copper LR tests

OTHER ACCESSORIES

HI 731318	cloth for wiping cuvettes (4 pcs)
HI 731321	glass cuvettes (4 pcs)
HI 731325W	new cap for cuvette (4 pcs)
HI 740034	cap for 100 mL beaker (6 pcs)
HI 740036	100 mL plastic beaker (6 pcs)
HI 740038	60 mL glass bottle and stopper
HI 740142	1 mL graduated syringe
HI 740143	1 mL graduated syringe (6 pcs)
HI 740144	pipette tip (6 pcs)
HI 740157	plastic refilling pipette (20 pcs)
HI 740220	25 mL glass cylinders with caps (2 pcs)
HI 740226	5 mL graduated syringe
HI 92000	Windows compatible software
HI 920013	PC connection cable
HI 93703-50	cuvette cleaning solution (230 mL)

WARRANTY

All Hanna Instruments meters are warranted for two years against defects in workmanship and materials when used for its intended purpose and maintained according to the instructions.

This warranty is limited to repair or replacement free of charge.

Damages due to accident, misuse, tampering or lack of prescribed maintenance are not covered.

If service is required, contact your dealer. If under warranty, report the model number, date of purchase, serial number and the nature of the failure. If the repair is not covered by the warranty, you will be notified of the charges incurred.

If the instrument is to be returned to Hanna Instruments, first obtain a Returned Goods Authorization Number from the Customer Service Department and then send it with shipment costs prepaid. When shipping any instrument, make sure it is properly packaged for complete protection.

To validate your warranty, fill out and return the enclosed warranty card within 14 days from the date of purchase.

Recommendations for Users

Before using these products, make sure that they are entirely suitable for your specific application and for the environment in which they are used.

Operation of these instruments may cause unacceptable interferences to other electronic equipments, this requiring the operator to take all necessary steps to correct interferences.

Any variation introduced by the user to the supplied equipment may degrade the instruments' EMC performance.

To avoid damages or burns, do not put the instrument in microwave ovens. For yours and the instrument safety do not use or store the instrument in hazardous environments.

Hanna Instruments reserves the right to modify the design, construction and appearance of its products without advance notice.

HANNA LITERATURE

Hanna publishes a wide range of catalogs and handbooks for an equally wide range of applications. The reference literature currently covers areas such as:

- **Water Treatment**
- **Process**
- **Swimming Pools**
- **Agriculture**
- **Food**
- **Laboratory**

and many others. New reference material is constantly being added to the library.

For these and other catalogs, handbooks and leaflets contact your dealer or the Hanna Customer Service Center nearest to you. To find the Hanna Office in your vicinity, check our home page at www.hannainst.com.



Hanna Instruments Inc.
Highland Industrial Park
584 Park East Drive
Woonsocket, RI 02895 USA

Technical Support for Customers
Tel. (800) 426 6287
Fax (401) 765 7575
E-mail tech@hannainst.com
www.hannainst.com

Local Sales and Customer Service Office

