

HI 83226
Multiparameter Bench
Photometer
for Pool & Spa Applications

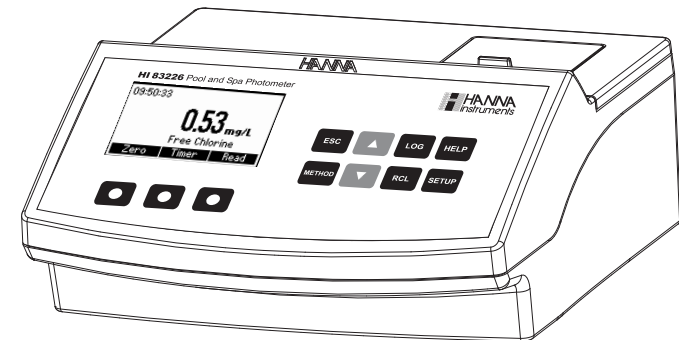

Dear Customer,

Thank you for choosing a Hanna product. Please read this instruction manual carefully before using the instrument. This manual will provide you with the necessary information for the correct use of the instrument. If you need additional technical information, do not hesitate to e-mail us at tech@hannainst.com.

TABLE OF CONTENTS

PRELIMINARY EXAMINATION	3
ABBREVIATIONS	3
GENERAL DESCRIPTION	3
SIGNIFICANCE OF POOL AND SPA TESTING	4
SPECIFICATIONS	8
PRECISION AND ACCURACY	8
PRINCIPLE OF OPERATION	8
FUNCTIONAL DESCRIPTION	10
TIPS FOR AN ACCURATE MEASUREMENT	11
HEALTH & SAFETY	14
METHOD REFERENCE TABLE	14
OPERATIONAL GUIDE	15
SETUP	17
HELP MODE	19
ALKALINITY	20
BROMINE	22
CALCIUM HARDNESS	24
FREE CHLORINE	27
TOTAL CHLORINE	29
FREE COPPER	31
TOTAL COPPER	33
CYANURIC ACID	35
IRON	37
OZONE	39
pH	42
ERRORS AND WARNINGS	44
DATA MANAGEMENT	45
STANDARD METHODS	45
ACCESSORIES	46
WARRANTY	47
HANNA LITERATURE	47

All rights are reserved. Reproduction in whole or in part is prohibited without the written consent of the copyright owner, Hanna Instruments Inc., Woonsocket, Rhode Island, 02895, USA.

PRELIMINARY EXAMINATION

Please examine this product carefully. Make sure that the instrument is not damaged. If any damage occurred during shipment, please notify your local Hanna Office.

Each Meter is supplied complete with:

- Four Sample Cuvettes and Caps
- Cloth for wiping cuvettes (1 pcs)
- Scissors
- AC/DC Power Adapter
- Instruction Manual

Note: Save all packing material until you are sure that the instrument works correctly. Any defective item must be returned in its original packing with the supplied accessories.

ABBREVIATIONS

EPA:	US Environmental Protection Agency
°C:	degree Celsius
°F:	degree Fahrenheit
µg/L:	micrograms per liter (ppb)
mg/L:	milligrams per liter (ppm)
g/L:	grams per liter (ppt)
mL:	milliliter
HR:	high range
MR:	medium range
LR:	low range
PAN:	1-(2-pyridylazo)-2-naphtol
TPTZ:	2,4,6-tri-(2-pyridyl)-1,3,5-triazine

GENERAL DESCRIPTION

HI 83226 is a multiparameter bench photometer dedicated for Pool & SPA applications. It measures 11 different methods using specific liquid or powder reagents. The amount of reagent is precisely dosed to ensure maximum reproducibility.

HI 83226 bench photometer can be connected to a PC via an USB cable. The optional HI 92000 Windows® Compatible Software helps users manage all their results.

HI 83226 has a powerful interactive user support that assists the user during the analysis process. Each step in the measurement process is help supported. A tutorial mode is available in the Setup Menu.

SIGNIFICANCE OF POOL AND SPA TESTING

A major family leisure pursuit is the enjoyment of Swimming Pool and Spa facilities world-wide. A basic necessity of Pool water treatment, to ensure such enjoyment, is to maintain the water in a safe and pleasant condition for the bathers.

In order to achieve such an objective, swimming pool water requires testing on daily, and sometimes hourly bases for disinfection residuals and pH. Equally important, Calcium Hardness and Alkalinity parameters should be monitored on weekly bases to ensure the pool water is maintained in a balanced condition, thus to avoid system failure because of corrosion or scale formation.

DISINFECTION RESIDUAL AND pH CONTROL

In terms of swimming pool treatment, disinfection or sanitizing basically means to rid the pool of bather pollution, destroy bacteria, and control nuisance organisms like algae, which may occur in the pool, filtration equipment, and piping.

There are a number of techniques used, namely, chlorine, bromine and ozone dosing systems, of which chlorine is the most common.

Chlorine

Chlorine is a strong oxidizing agent that destroys mostly organic pollutants, bacteria and can combine with nitrogen containing compounds, forming chloramines. Only a part of the original quantity dosed chlorine, remains active and continues its disinfecting action.

From the **free chlorine** you can distinguish **combined chlorine**, as that part which combines with nitrogen containing compound and that is less efficient as a disinfectant. The addition of these two parts gives **total chlorine**. A pool manager needs to aim perfection where free equals total chlorine, and thus to maintain the combined chlorine concentration near zero. The presence of chloramines is not desired because of the distinctive 'swimming pool' smell caused by combined chlorines like di-chloramines. Beside this unpleasant odour it does irritate the eyes and the mucous membranes.

Commercially chlorine for disinfection may be available as a gas (Cl_2), a liquid like sodium hypochlorite or bleach (NaOCl) or in a solid state like calcium hypochlorite, chloro-hydantoin or chloro-cyanuric acid compounds. These compounds, once dissolved in water do establish equilibrium between the hypochlorous acid (**HOCl**) and the hypochlorite ions (OCl^-). Although both forms are considered free chlorine, it is the hypochlorous acid that provides the strongest disinfecting and oxidising characteristic of chlorine solutions.

The amount of hypochlorous acid in chlorinated water depends upon the pH value of the solution. Changes in pH value will effect the HOCl equilibrium in relation to the hydrogen and hypochlorite ion.

As depicted by the curve on the next page, HOCl decreases and OCl^- increases as pH increases. At a low pH, almost all the free chlorine is in the molecular form HOCl and at a pH of around 7.5, the ratio between HOCl and OCl^- is 50:50. Since the ionic form OCl^- is a slow acting sanitizer while the molecular HOCl is a fast acting, it is important to measure regularly the pH. As a general rule a pH of about 7.2 is recommended to maintain fast acting disinfection conditions.

% HOCl vs pH

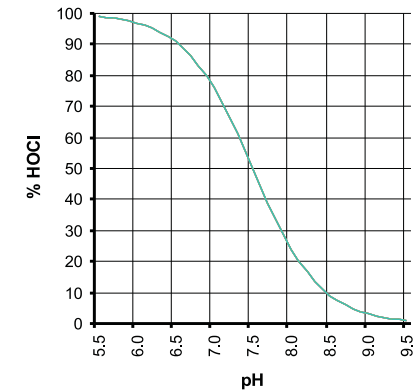

Bromine

In many countries bromine sanitizing has been introduced as an alternative for chlorine, although it is a less strong sanitizer. The advantage of bromine is its stability at higher temperatures (advantageous for hot well pools), and its maintained disinfection power at higher pH. Further it does hardly react with nitrogen compounds, reducing the unpleasant odour, and eye irritation problems. The main disadvantage of bromine is the slower acting disinfecting power, making it less suitable for larger pools.

Ozone

Ozone is a very strong oxidizing agent that does destroy most difficult to oxidize organic compounds and chloramines. It thus allows the pool manager to remove very efficiently combined chlorine without refreshing frequently large amounts of pool water. In general its application is found just before water passes through the filter units. Its sanitizing power is not pH related.

Mainly because of its strong oxidizing power the return water may contain only trace concentrations of ozone. It has to be mentioned that ozone is very unstable and there is anyway the need for low-level chlorination to ensure sanitizing throughout the whole pool.

THE WATER BALANCE AND LANGELIER INDEX (LI)

The pool water characteristics need to be maintained in a balanced condition to avoid system failure. Measuring the water balance is extremely important to predict if the water is corrosive, scaling or balanced.

A saturation index developed by Dr. Wilfred Langelier is widely used to predict the balance of swimming pool waters. It is an estimation of the solutions ability to dissolve or precipitate calcium carbonate deposits. A certain level of this precipitation (filming) is desired to insulate pipes and boilers from contact with water. When no protective filming is formed, water is considered to be corrosive. On the other hand scaling does cause failure because of incrustation problems.

In the treatment and monitoring of pool water, the pool manager must ensure that related parameters as alkalinity, hardness and pH are duly taken into consideration.

Calcium Hardness

The presence of calcium in the system is desired to ensure filming on those places where the temperature is relatively high, like in boilers and pipes transporting warm water. Scaling must be avoided because it reduces heat transfer and pump capacity. Beside the calcium carbonate deposits in the pipes, high scaling values do cause cloudy water. It is recommended to maintain the calcium hardness value within the range from 200 to 400 ppm as calcium carbonate (CaCO₃).

Alkalinity

Alkalinity is the measure of the total concentration of alkaline substances, mostly bicarbonates, dissolved in the water. The higher the alkalinity the more resistant the water is to pH change, the alkalinity *buffers* the water. At the same time, high alkaline water is a major contributor to scaling problems like incrustation in filtration equipment, pumps, and piping.

It is recommended to maintain the alkalinity value within the range from 80 to 125 ppm as calcium carbonate (CaCO₃).

pH

The pH of the water is an important factor since at lower pH the corrosion rate increases. If the alkalinity values are sufficiently high it will not be difficult to control the pH. Most pools managers do prefer to keep the pH between 7.2 and 7.4, that does ensure low corrosion rates and a sufficient activity of chlorine.

Langelier Index (LI)

The Langelier Index is a powerful tool to calculate the water balance, and to predict corrosion or scaling problems. Theoretically, a LI of zero indicates perfect water condition for swimming pools. If LI > 0, scaling and staining of the water is present, and if LI < 0 the water is corrosive and highly irritating. A tolerance of ±0.4 is normally acceptable.

The Langelier formula is expressed as:

$$LI = pH + TF + HF + AF - 12.5$$

where:

LI = Langelier Index (also called Saturation Index)

pH = pH of the water

TF = temperature factor

HF = hardness factor, log(Ca Hardness, ppm as CaCO₃)

AF = alkalinity factor, log(Alkalinity, ppm as CaCO₃)

To calculate the exact Langelier Index of your water please use the WATER INDEX reference tables at the end of this chapter to find the Temperature, Hardness and Alkalinity factors.

Recommendations

For most pools, water is balanced if:

- The pH value is maintained within the recommended ranges of **pH 7.2 - 7.6**
- Ideally the Alkalinity should be maintained within a range of **80 - 125 ppm**
- The Calcium Hardness should be maintained within a range of **200 - 400 ppm**.

To calculate your water balance three tests are required, measure the Calcium Hardness, the Alkalinity and the pH of the pool water. Find the **Hardness** and **Alkalinity Factor** in the WATER INDEX reference tables below. The water temperature is in general controlled between 24°C (76°F) and 34°C (94°F) to ensure pleasant bather comfort. The **Temperature Factor** in this temperature range has minor importance; therefore an average value of 0.7 may be used.

A simple calculation classifies your water in corrosive, scaling, acceptable or ideal balanced, with treatment recommendations:

$$\text{Water Balance} = pH + TF + HF + AF$$

Water Balance	Condition of Water	Recommendation
11.0 – 12.0	Corrosive	Increase pH and/or Alkalinity
12.1 – 12.3	Acceptable Balance	Retest water frequently
12.4 – 12.6	Ideal Balance	
12.7 – 12.9	Acceptable Balance	Retest water frequently
13.0 – 14.0	Scale forming	Reduce pH and/or alkalinity

WATER INDEX REFERENCE TABLES

Temperature			Calcium Hardness		Alkalinity	
°C	°F	TF	mg/L (as CaCO ₃)	HF	mg/L (as CaCO ₃)	AF
0	32	0	5	0.7	5	0.7
4	39	0.1	25	1.4	25	1.4
8	46	0.2	50	1.7	50	1.7
12	54	0.3	75	1.9	75	1.9
16	60	0.4	100	2.0	100	2.0
20	68	0.5	150	2.2	150	2.2
24	75	0.6	200	2.3	200	2.3
28	82	0.7	250	2.4	250	2.4
32	90	0.7	300	2.5	300	2.5
36	97	0.8	400	2.6	400	2.6
40	104	0.9	500	2.7	500	2.7
50	122	1.0	1000	3.0	1000	3.0

EXAMPLE:

Pool water conditions	Factor value (nearest values)
Temperature 30°C	TF = 0.7
pH 7.2	pH = 7.2
Alkalinity 80 mg/L	AF = 1.9
Hardness 230 mg/L	HF = 2.4

$$\text{Water Balance} = pH + TF + HF + AF = 7.2 + 0.7 + 2.4 + 1.9 = 12.2$$

Conclusion: the water is acceptable balanced but there is some risk that the water becomes corrosive; frequently testing is recommended.

SPECIFICATIONS

Light Life	Life of the instrument
Light Detector	Silicon Photocell
Environment	0 to 50°C (32 to 122°F); max 90% RH non-condensing
Power Supply	external 12 Vdc power adapter
Auto-Shut off	built-in rechargeable battery
Dimensions	235 x 200 x 110 mm (9.2 x 7.87 x 4.33")
Weight	0.9 Kg

For specifications related to each single method (e.g. range, resolution, etc.), refer to the related measurement section.

PRECISION AND ACCURACY

Precision is how closely repeated measurements agree with each other. Precision is usually expressed as standard deviation (SD).

Accuracy is defined as the nearness of a test result to the true value.

Although good precision suggests good accuracy, precise results can be inaccurate. The figure explains these definitions.

For each method, the precision is expressed in the related measurement section.

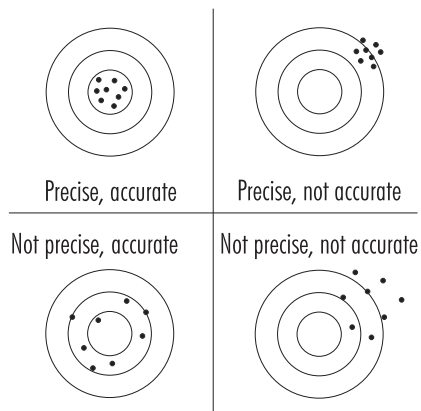

PRINCIPLE OF OPERATION

Absorption of light is a typical phenomenon of interaction between electromagnetic radiation and matter. When a light beam crosses a substance, some of the radiation may be absorbed by atoms, molecules or crystal lattices.

If pure absorption occurs, the fraction of light absorbed depends both on the optical path length through the matter and on the physical-chemical characteristics of substance according to the Lambert-Beer Law:

$$-\log \frac{I}{I_0} = \epsilon_{\lambda} c d$$

or

$$A = \epsilon_{\lambda} c d$$

Where:

$$-\log \frac{I}{I_0} = \text{Absorbance (A)}$$

$$I_0 = \text{intensity of incident light beam}$$

$$I = \text{intensity of light beam after absorption}$$

$$\epsilon_{\lambda} = \text{molar extinction coefficient at wavelength } \lambda$$

$$c = \text{molar concentration of the substance}$$

$$d = \text{optical path through the substance}$$

Therefore, the concentration "c" can be calculated from the absorbance of the substance as the other factors are known.

Photometric chemical analysis is based on the possibility to develop an absorbing compound from a specific chemical reaction between sample and reagents.

Given that the absorption of a compound strictly depends on the wavelength of the incident light beam, a narrow spectral bandwidth should be selected as well as a proper central wavelength to optimize measurements.

The optical system of **HI 83226** is based on special subminiature tungsten lamps and narrow-band interference filters to guarantee both high performance and reliable results.

Two measuring channels allow a wide range of tests.

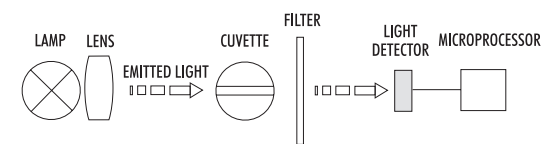

Instrument block diagram (optical layout)

A microprocessor controlled special tungsten lamp emits radiation which is first optically conditioned and beamed through the sample contained in the cuvette. The optical path is fixed by the diameter of the cuvette. Then the light is spectrally filtered to a narrow spectral bandwidth, to obtain a light beam of intensity I_0 or I . The photoelectric cell collects the radiation I that is not absorbed by the sample and converts it into an electric current, producing a potential in the mV range.

The microprocessor uses this potential to convert the incoming value into the desired measuring unit and to display it on the LCD.

The measurement process is carried out in two phases: first the meter is zeroed and then the actual measurement is performed.

The cuvette has a very important role because it is an optical element and thus requires particular attention. It is important that both the measurement and the calibration (zeroing) cuvette are optically identical to provide the same measurement conditions. Most methods use the same cuvette for both, so it is important that measurements are taken at the same optical point. The instrument and the cuvette cap have special marks that must be aligned in order to obtain better reproducibility.

The surface of the cuvette must be clean and not scratched. This is to avoid measurement interference due to unwanted reflection and absorption of light. It is recommended not to touch the cuvette walls with hands. Furthermore, in order to maintain the same conditions during the zeroing and the measurement phases, it is necessary to cap the cuvette to prevent any contamination.

FUNCTIONAL DESCRIPTION

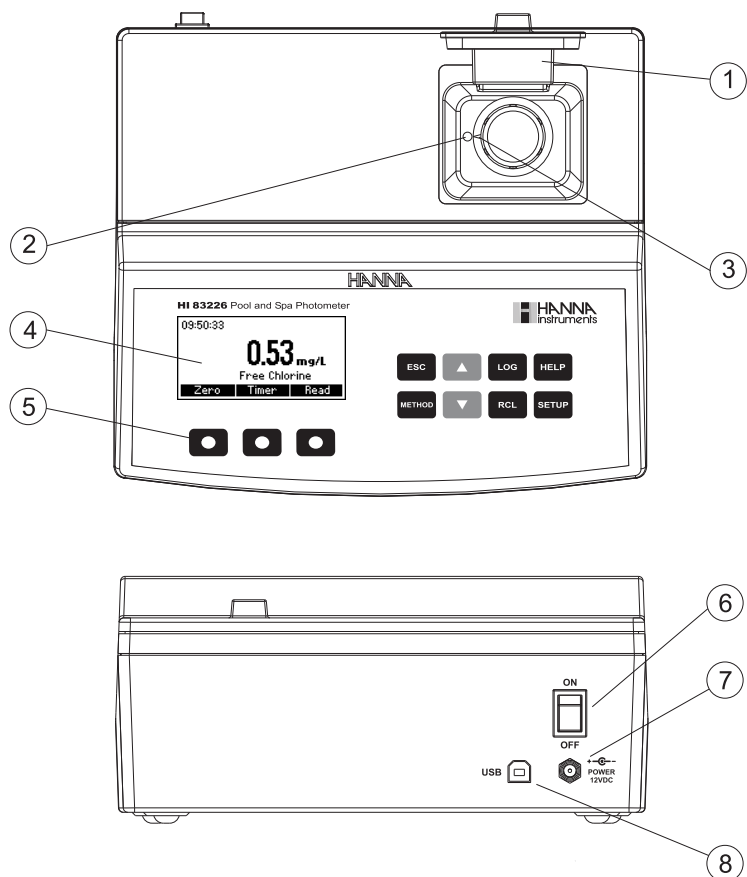

INSTRUMENT DESCRIPTION



- 1) Open Cuvette Lid
- 2) Indexing mark
- 3) Cuvette point
- 4) Liquid Crystal Display (LCD)
- 5) Splash proof keypad
- 6) ON/OFF power switch
- 7) Power input connector
- 8) USB connector

KEYPAD DESCRIPTION

The keypad contains 8 direct keys and 3 functional keys with the following functions:

-  Press to perform the function displayed above it on the LCD.
- ESC** Press to exit the current screen.
- METHOD** Press to access the select method menu.
-  Press to move up in a menu or a help screen, to increment a set value, to access second level functions.
-  Press to move down in a menu or a help screen, to decrement a set value, to access second level functions.
- LOG** Press to log the current reading.
- RCL** Press to recall the log.
- HELP** Press to display the help screen.
- SETUP** Press to access the setup screen.

TIPS FOR AN ACCURATE MEASUREMENT

The instructions listed below should be carefully followed during testing to ensure most accurate results.

- Color or suspended matter in large amounts may cause interference, and should be removed by treatment with active carbon and filtration.
- Ensure the cuvette is filled correctly: the liquid in the cuvette forms a convexity on the top; the bottom of this convexity must be at the same level as the 10 mL mark.

COLLECTING AND MEASURING SAMPLES

- In order to measure exactly 0.5 mL of reagent with the 1 mL syringe:
 - (a) push the plunger completely into the syringe and insert the tip into the solution.
 - (b) pull the plunger up until the lower edge of the seal is exactly on the 0.0 mL mark.

- (c) take out the syringe and clean the outside of the syringe tip. Be sure that no drops are hanging on the tip of the syringe, if so eliminate them. Then, keeping the syringe in vertical position above the cuvette, push the plunger down into the syringe until the lower edge of the seal is exactly on the 0.5 mL mark. Now the exact amount of 0.5 mL has been added to the cuvette, even if the tip still contains some solution.

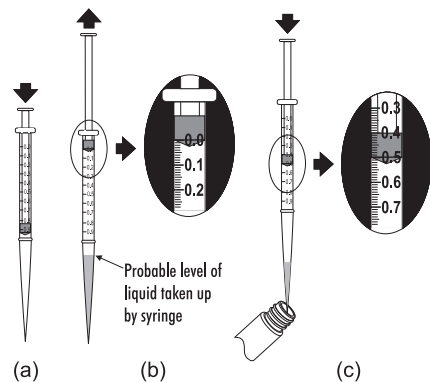

USING LIQUID AND POWDER REAGENTS

- Proper use of the dropper:
 - for reproducible results, tap the dropper on the table for several times and wipe the outside of the dropper tip with a cloth.
 - always keep the dropper bottle in a vertical position while dosing the reagent.

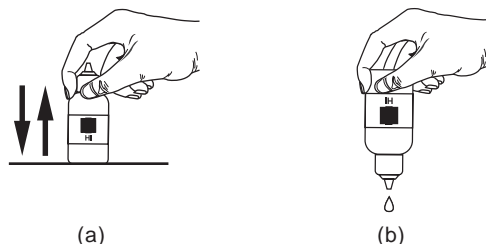

- Proper use of the powder reagent packet:
 - use scissors to open the powder packet;
 - push the edges of the packet to form a spout;
 - pour out the content of the packet.

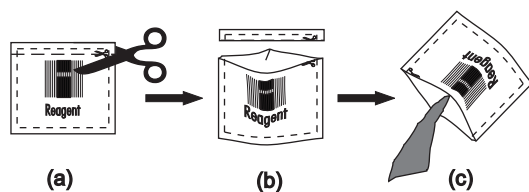

USING CUVETTES

- Proper mixing of the cuvette is done by **shaking the cuvette**, moving the cuvette up and down. The movement may be gentle or vigorous. This mixing method is indicated with "shake gently" or "shake vigorously", and one of the following icons:

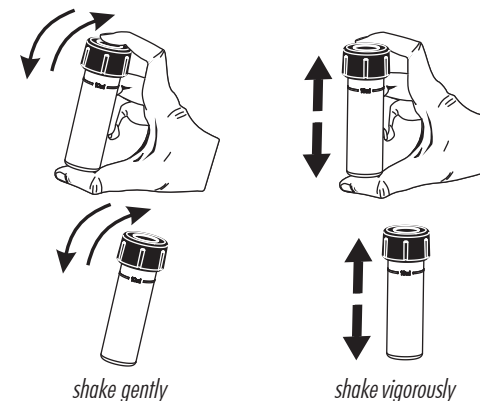

- Pay attention to push the cuvette completely down in the holder and to align the white point on the cap to the indexing mark on the meter.

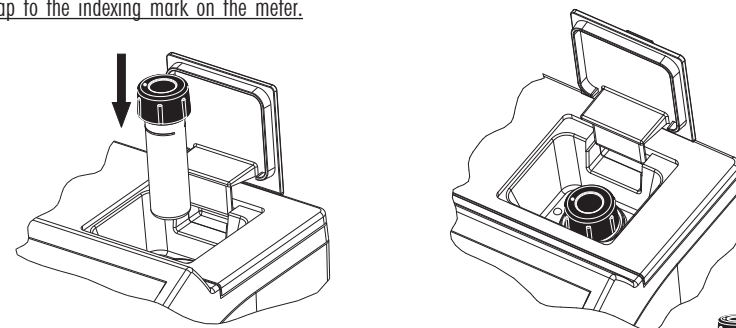

- In order to avoid reagent leaking and to obtain more accurate measurements, close the cuvette first with the supplied HDPE plastic stopper and then the black cap.
- Whenever the cuvette is placed into the measurement cell, it must be dry outside, and free of fingerprints, oil or dirt. Wipe it thoroughly with HI 731318 or a lint-free cloth prior to insertion.
- Shaking the cuvette can generate bubbles in the sample, causing higher readings. To obtain accurate measurements, remove such bubbles by swirling or by gently tapping the cuvette.
- Do not let the reacted sample stand too long after reagent is added. For best accuracy, respect the timings described in each

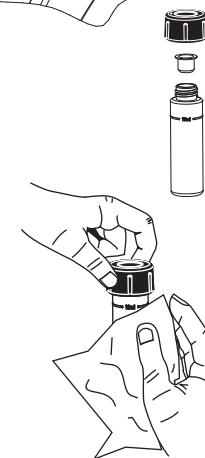

specific method.

- It is possible to take multiple readings in a row, but it is recommended to take a new zero reading for each sample and to use the same cuvette for zeroing and measurement when possible (for most precise results follow the measurement procedures carefully).
- Discard the sample immediately after the reading is taken, or the glass might become permanently stained.
- All the reaction times reported in this manual are at 25 °C (77 °F). In general, the reaction time should be increased for temperatures lower than 20 °C (68 °F), and decreased for temperatures higher than 25 °C (77 °F).

INTERFERENCES

- In the method measurement section the most common interferences that may be present in an average sample matrix have been reported. It may be that for a particular treatment process other compounds do interfere with the method of analysis.

HEALTH & SAFETY



- The chemicals contained in the reagent kits may be hazardous if improperly handled.
- Read the Material Safety Data Sheet (MSDS) before performing tests.

- **Safety equipment:** Wear suitable eye protection and clothing when required, and follow instructions carefully.
- **Reagent spills:** If a reagent spill occurs, wipe up immediately and rinse with plenty of water. If reagent contacts skin, rinse the affected area thoroughly with water. Avoid breathing released vapors.
- **Waste disposal:** for proper disposal of reagent kits and reacted samples, refer to the Material Safety Data Sheet (MSDS).

METHOD REFERENCE TABLE

Method	Method description	Page
1	Alkalinity	20
2	Bromine	22
3	Calcium Hardness	24
4	Free Chlorine	27
5	Total Chlorine	29
6	Free Copper	31

Method	Method description	Page
7	Total Copper	33
8	Cyanuric Acid	35
9	Iron	37
10	Ozone	39
11	pH	42

OPERATIONAL GUIDE

POWER CONNECTION AND BATTERY MANAGEMENT

The meter can be powered from an AC/DC adapter (included) or from the built-in rechargeable battery.

Note: Always turn the meter off before unplugging it to ensure no data is lost.

When the meter switches ON, it verifies if the power supply adapter is connected. The battery icon on the LCD will indicate the battery status:

- battery is charging from external adapter
- battery fully charged (meter connected to AC/DC adapter)

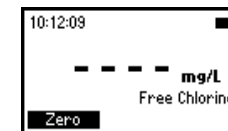

- battery capacity (no external adapter)

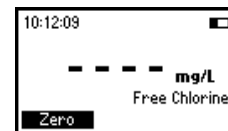

- battery Low (no external adapter)

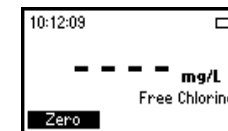

- battery Dead (no external adapter)



METHOD SELECTION

- Turn the instrument ON via the ON/OFF power switch.
- The meter will perform an autodiagnostic test. During this test, the Hanna Instrument logo will appear on the LCD. After 5 seconds, if the test was successful, the last method used will appear on the display.
- In order to select the desired method press the **METHOD** key and a screen with the available methods will appear.
- Press the ▲ ▼ keys to highlight the desired method. Press **Select**.

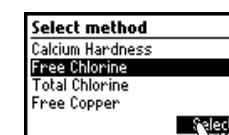
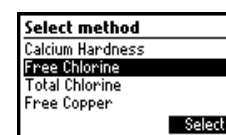

- After the desired method is selected, follow the measurement described in the related section.
- Before performing a test you should read all the instructions carefully.

DATA MANAGEMENT

The instrument features a data log function to help you keep track of all your analysis. The data log can hold 200 individual measurements. Storing, viewing and deleting the data is possible using the **LOG** and **RCL** keys.

Storing data: You can store only a valid measurement. Press **LOG** and the last valid measurement will be stored with date and time stamps.

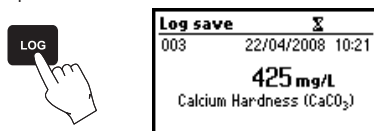

Viewing and deleting: You can view and delete the data log by pressing the **RCL** key. You can only delete the last saved measurement. Additionally, you can delete the data records all at once.

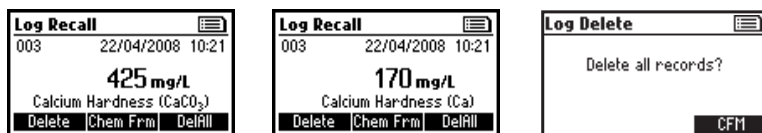

CHEMICAL FORM

Chemical form conversion factors are pre-programmed into the instrument and are method specific. In order to view the displayed result in the desired chemical form press **▲** or **▼** to access the second level functions and then press the **Chem Frm** key to toggle between the available chemical forms for the selected method.

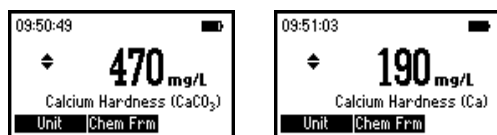

SPECIAL CONVERSIONS

For Calcium Hardness, special conversion factors can be used to convert the readings from mg/L to French degrees (°f), German degrees (°dH) and English degrees (°E) of hardness. This can be achieved by pressing **▲** or **▼** to access the second level functions and then press the **Unit** functional key to toggle between °f, °dH, °E and mg/L.

SETUP

In the Setup mode the instrument's parameters can be changed. Some parameters affect the measuring sequence and others are general parameters that change the behavior or appearance of the instrument.

Press **SETUP** to enter the setup mode.

Press **ESC** or **SETUP** to return to the main screen.

A list of setup parameters will be displayed with currently configured settings. Press **HELP** for additional information.

Press the **▲** **▼** keys to select a parameter and change the value as follows:



Backlight

Values: 0 to 8.

Press the **Modify** key to access the backlight value.

Use the **◀▶** functional keys or the **▲▼** keys to increase or decrease the value.

Press the **Accept** key to confirm or **ESC** to return to the setup menu without saving the new value.

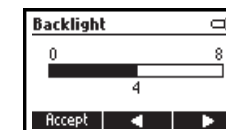
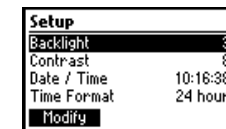

Contrast

Values: 0 to 20.

This option is used to set the display's contrast.

Press the **Modify** key to change the display's contrast.

Use the **◀▶** functional keys or the **▲▼** keys to increase or decrease the value.

Press the **Accept** key to confirm the value or **ESC** to return to the setup menu without saving the new value.

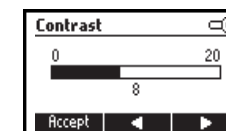
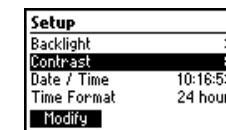

Date / Time

This option is used to set the instrument's date and time.

Press the **Modify** key to change the date/time.

Press the ◀ ▶ functional keys to highlight the value to be modified (year, month, day, hour, minute or second). Use the ▲ ▼ keys to change the value.

Press the **Accept** key to confirm or **ESC** to return to the setup without saving the new date or time.

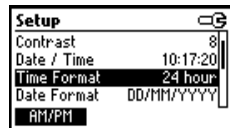
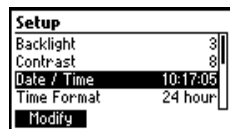

Time format

Option: AM/PM or 24 hour.

Press the functional key to select the desired time format.

Date format

Press the **Modify** key to change the Date Format.

Use the ▲ ▼ keys to select the desired format.

Press **Accept** key to confirm or **ESC** to return to the setup menu without saving the new format.

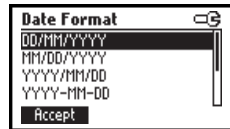
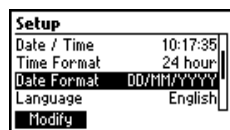

Language

Press the corresponding key to change the language.

If the new language cannot be loaded, the previously selected language will be reloaded.

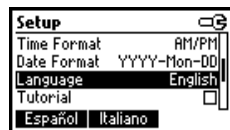

Tutorial

Option: Enable or Disable.

If enabled this option will provide the user short guide related to the current screen.

Press the functional key to enable/disable the tutorial mode.

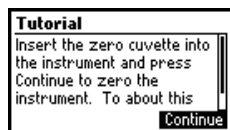
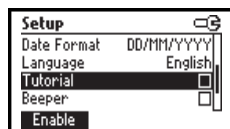

Beeper

Option: Enable or Disable.

When enabled, a short beep is heard every time a key is pressed.

A long beep alert sounds when the pressed key is not active or an error is detected.

Press the functional key to enable/disable the beeper.

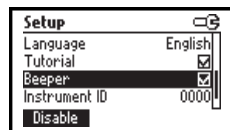

Instrument ID

Option: 0 to 9999.

This option is used to set the instrument's ID (identification number). The instrument ID is used while exchanging data with a PC.

Press the **Modify** key to access the instrument ID screen. Press the ▲ ▼ keys in order to set the desired value.

Press the **Accept** key to confirm the value or **ESC** to return to the setup menu without saving the new value.

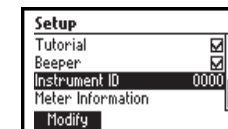

Meter information

Press the **Select** key to view the instrument model, firmware version, language version and instrument serial number.

Press **ESC** to return to the Setup mode.

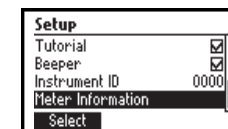

HELP MODE

HI 83226 offers an interactive contextual help mode that assists the user at any time.

To access the help screens press **HELP**.

The instrument will display additional information related to the current screen. To read all the available information, scroll the text using the ▲ ▼ keys.

Press the **Support** key to access a screen with Hanna service centers and their contact details.

Press the **Accessories** key to access a list of instrument reagents and accessories.

To exit support or accessories screens press **ESC** and the instrument will return to the previous help screen.

To exit help mode press the **HELP** or **ESC** key again and the meter will return to the previously selected screen.

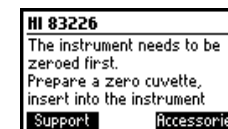

ALKALINITY

SPECIFICATIONS

Range	0 to 500 mg/L (as CaCO ₃)
Resolution	5 mg/L
Accuracy	±5 mg/L ±10% of reading at 25 °C
Typical EMC Deviation	±5 mg/L
Light Source	Tungsten lamp with narrow band interference filter @ 575 nm
Method	Colorimetric Method. At different alkalinity levels a distinctive range of colors from yellow to green and greenish blue will develop.

REQUIRED REAGENTS

Code	Description	Quantity/test
HI 93755-0	Alkalinity Indicator Reagent	1 mL

REAGENT SETS

HI 93755-01 Reagents for 100 tests
 HI 93755-03 Reagents for 300 tests
 For other accessories see page 46.

MEASUREMENT PROCEDURE

- Select the *Alkalinity* method using the procedure described in the *Method Selection* section (see page 15).
- Fill the cuvette with 10 mL of unreacted sample, up to the mark, and replace the cap.
- Place the cuvette into the holder and close the lid.

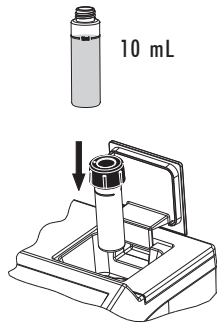

- Press the **Zero** key. The display will show “-0.0-” when the meter is zeroed and ready for measurement.

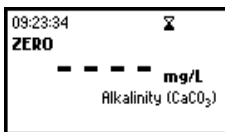
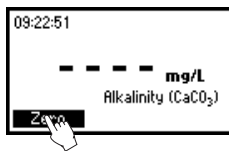

- Remove the cuvette.
- Carefully add exactly 1 mL of HI 93755-0 Liquid Alkalinity Reagent using the supplied syringe.

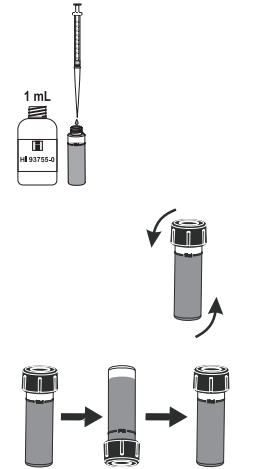

- Replace the cap and invert 5 times.
- Reinsert the cuvette into the instrument and close the lid.

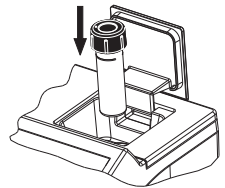

- Press **Read** to start the reading.

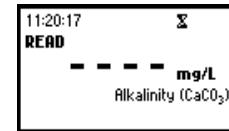
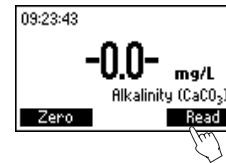

- The instrument displays the results in **mg/L of alkalinity (CaCO₃)**.

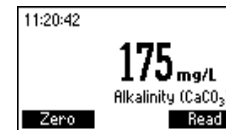

Note: If using a meter with software version 1.14 or earlier, readings can be improved for samples with less than 75 ppm alkalinity by adding 0.7 mL of reagent instead of 1.0 mL.

BROMINE

SPECIFICATIONS

Range	0.00 to 10.00 mg/L
Resolution	0.01 mg/L
Accuracy	±0.08 mg/L ±3% of reading at 25 °C
Typical EMC	±0.01 mg/L
Deviation	
Light Source	Tungsten lamp with narrow band interference filter @ 525 nm
Method	Adaptation of the <i>Standard Methods for the Examination of Water and Wastewater, 20th edition</i> , DPD method. The reaction between bromine and the reagent causes a pink tint in the sample.

REQUIRED REAGENTS

Code	Description	Quantity
HI 93716-0	DPD Reagent	1 packet

REAGENT SETS

HI 93716-01 Reagents for 100 tests
 HI 93716-03 Reagents for 300 tests
 For other accessories see page 46.

MEASUREMENT PROCEDURE

• Select the *Bromine* method using the procedure described in the *Method Selection* section (see page 15).

• Fill the cuvette with 10 mL of unreacted sample (up to the mark) and replace the cap.

• Place the cuvette into the holder and close the lid.

• Press the **Zero** key. The display will show “-0.0-” when the meter is zeroed and ready for measurement.

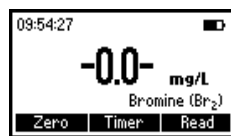
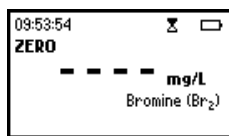
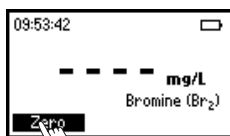
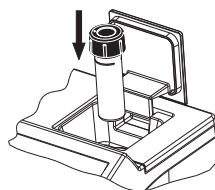

• Remove the cuvette and add the content of one packet of HI 93716-0 DPD reagent. Replace the cap and shake gently for about 20 seconds to dissolve most of the reagent.

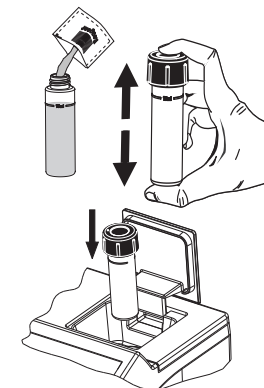

• Reinsert the cuvette into the instrument.

• Press **Timer** and the display will show the countdown prior to the measurement or, alternatively, wait for 2 minutes and 30 seconds and press **Read**. When the timer ends the meter will perform the reading.

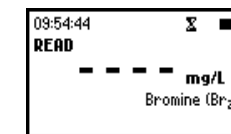
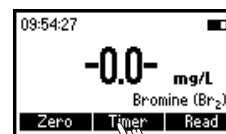

• The instrument displays the results in **mg/L** of bromine.



INTERFERENCES

Interference may be caused by: Chlorine, Iodine, Ozone, Oxidized forms of Chromium and Manganese. In case of water with hardness greater than 500 mg/L CaCO₃, shake the sample for approximately 2 minutes after adding the reagent.

In case of water with alkalinity greater than 250 mg/L CaCO₃ or acidity greater than 150 mg/L CaCO₃, the color of the sample may develop only partially, or may rapidly fade. To resolve this, neutralize the sample with diluted HCl or NaOH.

CALCIUM HARDNESS

SPECIFICATIONS

Range	0 to 500 mg/L (as CaCO ₃)
Resolution	5 mg/L
Accuracy	±10 mg/L ±5% of reading at 25 °C
Typical EMC	±5 mg/L
Deviation	
Light Source	Tungsten lamp with narrow band interference filter @ 525 nm
Method	Adaptation of the <i>Standard Methods for the Examination of Water and Wastewater, 18th edition</i> , Calmagite method. The reaction between calcium and reagents causes a reddish-violet tint in the sample.

REQUIRED REAGENTS

Code	Description	Quantity
HI 93720A-0	Ca & Mg indicator	0.5 mL
HI 93720B-0	Alkali solution	0.5 mL
HI 93720C-0	EGTA solution	1 drop

REAGENT SETS

HI 93720-01 Reagents for 100 tests

HI 93720-03 Reagents for 300 tests

For other accessories see page 46.

MEASUREMENT PROCEDURE

- Select the *Calcium Hardness* method using the procedure described in the *Method Selection* section (see page 15).

- Rinse a graduated beaker several times with deionized water, fill a 1 mL syringe with the sample, and inject 0.5 mL into the beaker. Fill the beaker up to the 50 mL mark with hardness-free water.

- Add 0.5 mL of HI 93720A-0 Calcium indicator solution and swirl to mix.

- Add 0.5 mL of HI 93720B-0 Alkali solution and swirl to mix. Use this solution to rinse 2 cuvettes before filling them up to the 10 mL mark.

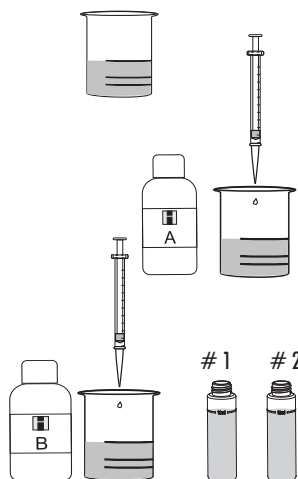

- Add 1 drop of HI 93720C-0 EGTA solution to one cuvette (# 1), replace the cap and invert the cuvette several times to mix. This is the blank.

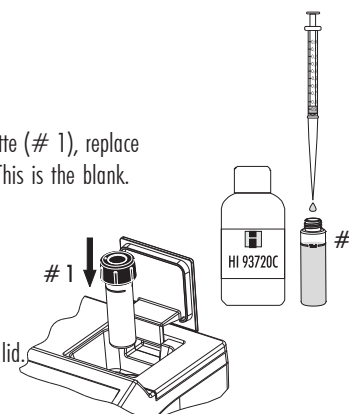

- Place the blank (# 1) into the holder and close the lid.
- Press the **Zero** key. The meter will show “-0.0-” when the meter is zeroed and ready for measurement.

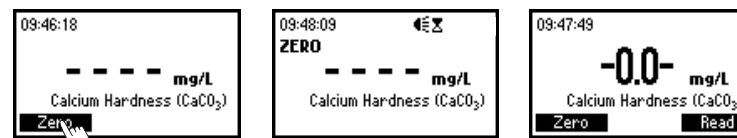

- Remove the blank and insert the second cuvette (# 2) into the instrument.

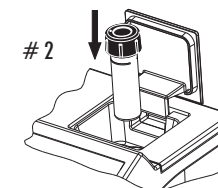

- Press **Read** to start the reading. The instrument displays concentration in mg/L of calcium hardness, as CaCO₃.

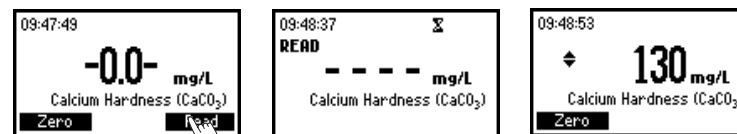

- Press ▲ or ▼ to access the second level functions.
- Press the **Chem Frm** key to convert the result in mg/L of Calcium (Ca).

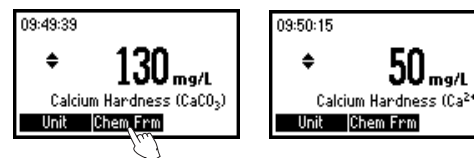

- Press the **Unit** key to change the current measurement unit. The results can be converted to French degrees (°f), German degrees (°dH) and English degrees (°E).

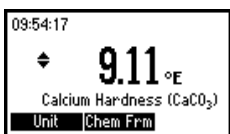
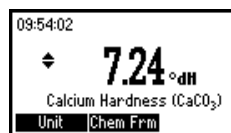
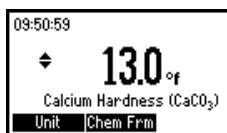
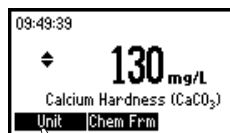

- Press ▲ or ▼ to return to the measurement screen.

Note: This test will detect any calcium contamination in the beaker, measuring syringes or sample cells. To test cleanliness, repeat the test multiple times until you obtain consistent results.

Note: For better accuracy wash glassware with HCl 6N.

INTERFERENCES

Interference may be caused by excessive amounts of heavy metals.

FREE CHLORINE

SPECIFICATIONS

Range	0.00 to 5.00 mg/L
Resolution	0.01 mg/L from 0.00 to 2.50 mg/L; 0.10 mg/L above 2.50 mg/L
Accuracy	±0.03 mg/L ±3% of reading at 25 °C
Typical EMC Deviation	±0.01 mg/L
Light Source	Tungsten lamp with narrow band interference filter @ 525 nm
Method	Adaptation of the USEPA method 330.5 and <i>Standard Methods for the Examination of Water and Wastewater, 20th edition, 4500-Cl G</i> . The reaction between free chlorine and the DPD reagent causes a pink tint in the sample.

REQUIRED REAGENTS

Code	Description	Quantity
HI 93701-0	DPD powder Reagent	1 packet

REAGENT SETS

HI 93701-01 Reagents for 100 tests

HI 93701-03 Reagents for 300 tests

For other accessories see page 46.

MEASUREMENT PROCEDURE

- Select the *Free Chlorine* method using the procedure described in the *Method Selection* section (see page 15).
- Fill the cuvette with 10 mL of unreacted sample (up to the mark) and replace the cap.
- Place the cuvette into the holder and close the lid.

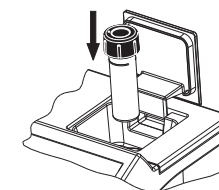

- Press the **Zero** key. The meter will show “-0.0-” when the meter is zeroed and ready for measurement.

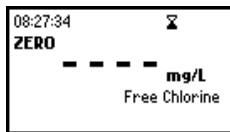
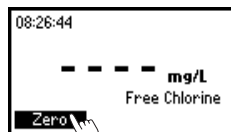

- Remove the cuvette.
- Add the content of one packet of HI 93701-0 DPD reagent. Replace the cap and shake gently for 20 seconds.
- Reinsert the cuvette into the instrument.

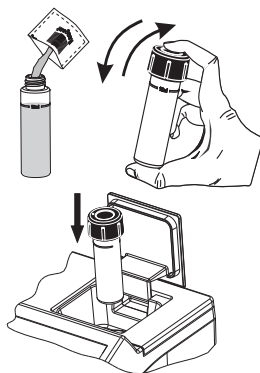

- Press **Timer** and the display will show the countdown prior to the measurement or, alternatively, wait for 1 minute and press **Read**. When the timer ends the meter will perform the reading.

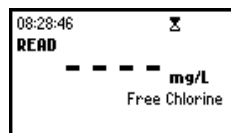
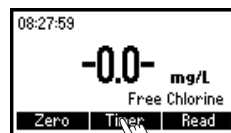

- The instrument displays the results in mg/L of free chlorine.



INTERFERENCES

Interference may be caused by: Bromine, Chlorine Dioxide, Iodine, Ozone (all these interferences give positive errors). Alkalinity above 250 mg/L CaCO₃ will not reliably develop the full amount of color or it may rapidly fade. To resolve this, neutralize the sample with diluted HCl. In case of water with hardness greater than 500 mg/L CaCO₃, shake the sample for approximately 2 minutes after adding the powder reagent.

TOTAL CHLORINE

SPECIFICATIONS

Range	0.00 to 5.00 mg/L
Resolution	0.01 mg/L from 0.00 to 2.50 mg/L; 0.10 mg/L above 2.50 mg/L
Accuracy	±0.03 mg/L ±3% of reading at 25 °C
Typical EMC Deviation	±0.01 mg/L
Light Source	Tungsten lamp with narrow band interference filter @ 525 nm
Method	Adaptation of the EPA method 330.5 and <i>Standard Methods for the Examination of Water and Wastewater, 20th edition</i> , 4500-Cl G. The reaction between chlorine and the DPD reagent causes a pink tint in the sample.

REQUIRED REAGENTS

POWDER:

<u>Code</u>	<u>Description</u>	<u>Quantity</u>
HI 93711-0	DPD Powder Reagent	1 packet

REAGENT SETS

HI 93711-01 Reagents for 100 tests
HI 93711-03 Reagents for 300 tests

For other accessories see page 46.

MEASUREMENT PROCEDURE

- Select the *Total Chlorine* method using the procedure described in the *Method Selection* section (see page 15).
- Fill the cuvette with 10 mL of unreacted sample (up to the mark) and replace the cap.
- Place the cuvette into the holder and close the lid.

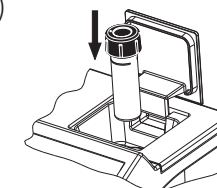

- Press the **Zero** key. The meter will show “-0.0-” when the meter is zeroed and ready for measurement.

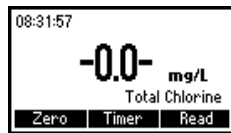
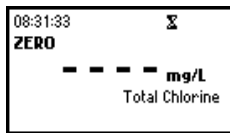
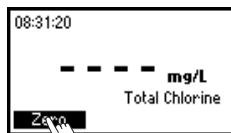

- Remove the cuvette.
- Add 1 packet of HI 93711-0 DPD reagent. Replace the cap and shake gently for 20 seconds.

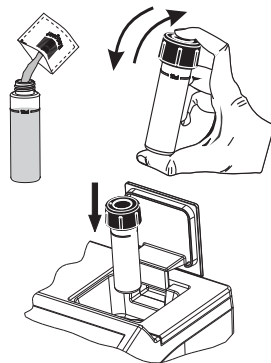

- Reinsert the cuvette into the instrument.

- Press **Timer** and the display will show the countdown prior to the measurement or, alternatively, wait for 2 minutes and 30 seconds and press **Read**. When the timer ends the meter will perform the reading.

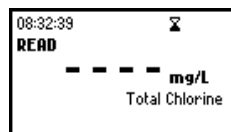
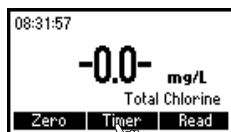

- The instrument displays the results in **mg/L** of total chlorine.

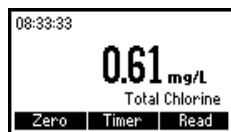

INTERFERENCES

Interference may be caused by: Bromine, Chlorine Dioxide, Iodine, Ozone (all these interferences give positive errors). Alkalinity above 250 mg/L CaCO₃ will not reliably develop the full amount of color or it may rapidly fade. To resolve this, neutralize the sample with diluted HCl.

In case of water with hardness greater than 500 mg/L CaCO₃, shake the sample for approximately 2 minutes after adding the powder reagent.

FREE COPPER

SPECIFICATIONS

Range	0.00 to 5.00 mg/L
Resolution	0.01 mg/L
Accuracy	±0.02 mg/L ±4% of reading at 25 °C
Typical EMC Deviation	±0.01 mg/L
Light Source	Tungsten lamp with narrow band interference filter @ 575 nm
Method	Adaptation of the <i>EPA method</i> . The reaction between copper and the bicinchoninate reagent causes a purple tint in the sample.

REQUIRED REAGENTS

Code	Description	Quantity/test
HI 93702-0	Bicinchoninate	1 packet

REAGENT SETS

HI 93702-01 Reagents for 100 tests

HI 93702-03 Reagents for 300 tests

For other accessories see page 46.

MEASUREMENT PROCEDURE

- Select the *Free Copper* method using the procedure described in the *Method Selection* section (see page 15).



- Fill the cuvette with 10 mL of unreacted sample (up to the mark) and replace the cap.

- Place the cuvette into the holder and close the lid.

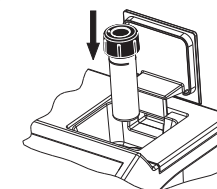

- Press the **Zero** key. The meter will show “-0.0-” when the meter is zeroed and ready for measurement.

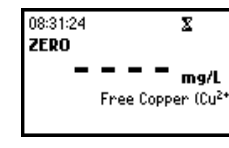
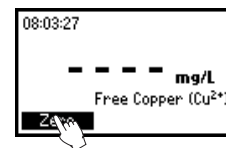

- Remove the cuvette.
- Add the content of one packet of HI 93702-0 Copper Reagent. Replace the cap and shake gently for 15 seconds.

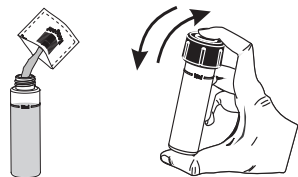

- Reinsert the cuvette into the instrument.

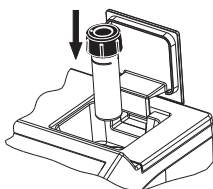

- Press **Timer** and the display will show the countdown prior to the measurement or, alternatively, wait for 45 seconds and press **Read**. When the timer ends the meter will perform the reading.

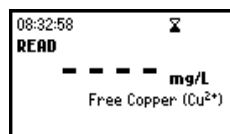
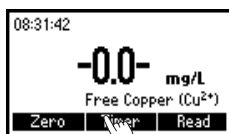

- The instrument displays the results in mg/L of copper.

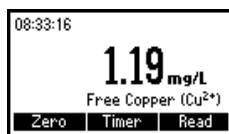

INTERFERENCES

Interference may be caused by:

Silver
Cyanide

For samples overcoming buffering capacity of reagent (around pH 6.8), pH should be adjusted between 6 and 8.

TOTAL COPPER

SPECIFICATIONS

Range	0.00 to 5.00 mg/L
Resolution	0.01 mg/L
Accuracy	±0.02 mg/L ±4% of reading at 25 °C
Typical EMC	±0.01 mg/L
Deviation	
Light Source	Tungsten lamp with narrow band interference filter @ 575 nm
Method	Adaptation of the USEPA approved method. The reaction between free copper and the bicinchoninate reagent causes a purple tint in the sample.

REQUIRED REAGENTS

Code	Description	Quantity/test
HI 93702-0	Bicinchoninate	1 packet
HI 93702T-0	Decomplexing Agent	1 packet

REAGENT SETS

HI 93702T-01, HI 93702-01	Reagents for 100 tests
HI 93702T-03, HI 93702-03	Reagents for 300 tests

For other accessories see page 46.

MEASUREMENT PROCEDURE

- Select the *Total Copper* method using the procedure described in the *Method Selection* section (see page 15).
- Fill the cuvette with 10 mL of unreacted sample (up to the mark) and replace the cap.
- Place the cuvette into the holder and close the lid.

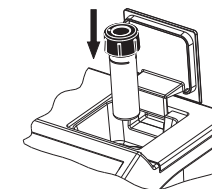

- Press the **Zero** key. The meter will show “-0.0-” when the meter is zeroed and ready for measurement.

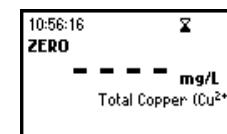
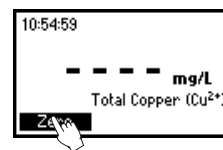

- Remove the cuvette.
- Add the content of one packet of HI 93702-0 Copper Reagent. Replace the cap and shake gently for 15 seconds.
- Add the content of one packet of HI 93702T-0 Copper Total Reagent. Replace the cap and shake vigorously for 15 seconds.
- Replace the cuvette into the holder and ensure that the notch on the cap is positioned securely into the groove.

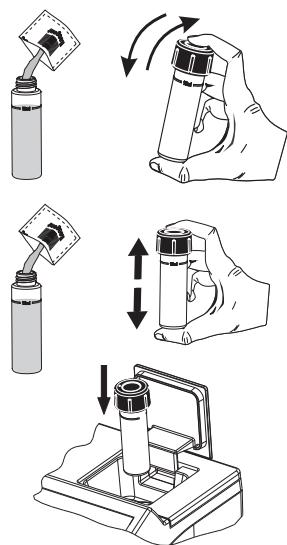

- Press **Timer** and the display will show the countdown prior to measurement or, alternatively, wait for 45 seconds and press **Read**. When the timer ends the meter will perform the reading.

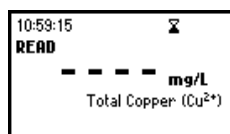
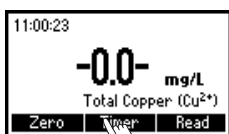

- The instrument displays concentration in mg/L of total copper.

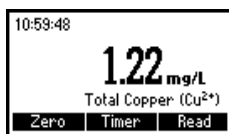

CYANURIC ACID

SPECIFICATIONS

Range	0 to 200 mg/L
Resolution	1 mg/L from 0 to 100 mg/L; 10 mg/L above 100 mg/L
Accuracy	±1 mg/L ±15% of reading at 25 °C
Typical EMC Deviation	±1 mg/L
Light Source	Tungsten lamp with narrow band interference filter @ 525 nm
Method	Adaptation of the turbidimetric method. The reaction between cyanuric acid and the reagent causes a white suspension in the sample.

REQUIRED REAGENTS

<u>Code</u>	<u>Description</u>	<u>Quantity</u>
HI 93722-0	Powder reagent	1 packet

REAGENT SETS

HI 93722-01 Reagents for 100 tests

HI 93722-03 Reagents for 300 tests

For other accessories see page 46.

MEASUREMENT PROCEDURE

- Select the *Cyanuric Acid* method using the procedure described in the *Method Selection* section (see page 15).
- Fill the cuvette with 10 mL of unreacted sample (up to the mark) and replace the cap.
- Place the cuvette into the holder and close the lid.

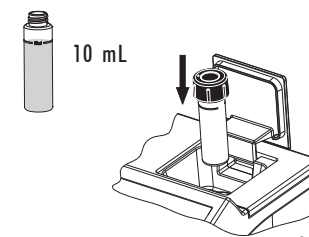

- Press the **Zero** key. The meter will show “-0.0-” when the meter is zeroed and ready for measurement.

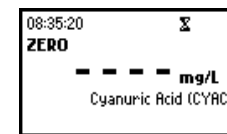
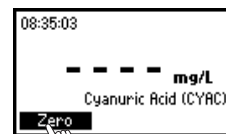

- Add the content of one packet of HI 93722-0 Cyanuric Acid Reagent. Replace the cap and shake gently for about 10 seconds (dissolution is not complete).

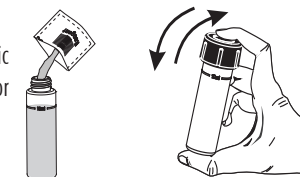

- Reinsert the cuvette into the instrument.

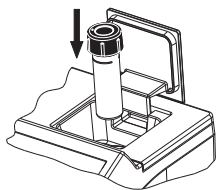

- Press **Timer** and the display will show the countdown prior to the measurement or, alternatively, wait for 45 seconds and press **Read**. When the timer ends the meter will perform the reading.

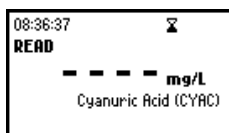
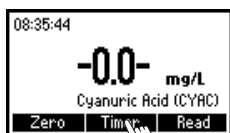

- The instrument displays concentration in **mg/L** of cyanuric acid.

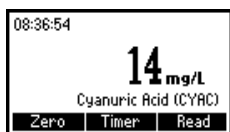

INTERFERENCES

Turbidity preexisting in the sample causes interference during measurement.

IRON

SPECIFICATIONS

Range	0.00 to 5.00 mg/L
Resolution	0.01 mg/L
Accuracy	± 0.04 mg/L $\pm 2\%$ of reading at 25 °C
Typical EMC	± 0.01 mg/L
Deviation	
Light Source	Tungsten lamp with narrow band interference filter @ 525 nm
Method	Adaptation of the <i>EPA Phenantroline method 315B</i> , for natural and treated waters. The reaction between iron and reagents causes an orange tint in the sample.

REQUIRED REAGENTS

Code	Description	Quantity/test
HI 93721-0	Iron High Range Reagent	1 packet

REAGENT SETS

HI 93721-01 Reagents for 100 tests

HI 93721-03 Reagents for 300 tests

For other accessories see page 46.

MEASUREMENT PROCEDURE

- Select the *Iron* method using the procedure described in the *Method Selection* section (see page 15).
- Fill the cuvette with 10 mL of unreacted sample (up to the mark) and replace the cap.
- Place the cuvette into the holder and close the lid.

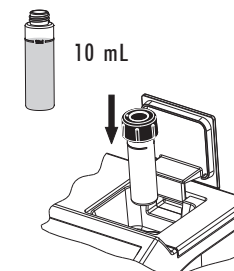

- Press the **Zero** key. The meter will show “-0.0-” when the meter is zeroed and ready for measurement.

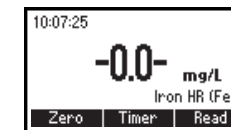
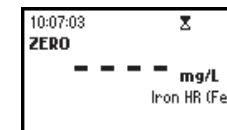
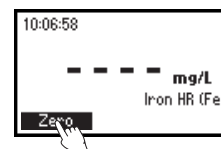

- Remove the cuvette and add the content of one packet of HI 93721-0 reagent. Replace the cap and shake until dissolution is complete.

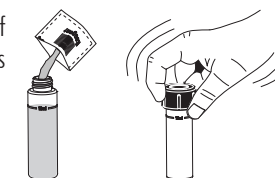

- Reinsert the cuvette into the instrument.

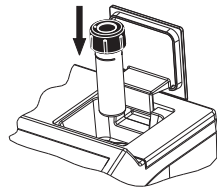

- Press **Timer** and the display will show the countdown prior to the measurement or, alternatively, wait for 3 minutes and press **Read**. When the timer ends the meter will perform the reading.

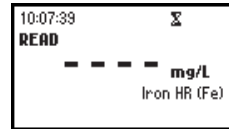

- The instrument displays concentration in **mg/L** of iron.



INTERFERENCES

Interference may be caused by:

Molybdate Molybdenum above 50 ppm

Calcium above 10000 ppm (as CaCO₃)

Magnesium above 100000 ppm (as CaCO₃)

Chloride above 185000 ppm.

OZONE

SPECIFICATIONS

Range 0.00 to 2.00 mg/L

Resolution 0.01 mg/L

Accuracy ±0.02 mg/L ±3% of reading at 25 °C

Typical EMC Deviation ±0.01 mg/L

Light Source Tungsten lamp with narrow band interference filter @ 525 nm

Method Colorimetric DPD Method. The reaction between ozone and the DPD reagent causes a pink tint in the sample.

REQUIRED REAGENTS

Code	Description	Quantity/test
HI 93757-0	DPD Powder Reagent	1 packet
HI 93703-52-0	Glycine Powder (Optional Reagent)	1 packet

REAGENT SETS

HI 93757-01 Reagents for 100 tests

HI 93757-03 Reagents for 300 tests

HI 93703-52 Glycine Powder, Optional Reagent for 100 tests

For other accessories see page 46.

IMPORTANT NOTE: Chlorine is a strong interferent for ozone determination. If the sample is suspected to contain chlorine residues (free or total chlorine), please follow the **alternative** measurement procedure described below:

- Perform the Standard Measurement Procedure and take note of the reading: *value A*.
- On a fresh sample perform the Additional Measurement Procedure and take note of the reading: *value B*.
- Subtract reading *B* from reading *A* to obtain the ozone concentration in mg/L:
mg/L (O₃) = *value A* – *value B*.

STANDARD MEASUREMENT PROCEDURE

- Select the *Ozone* method using the procedure described in the *Method Selection* section (see page 15).

- Fill the cuvette with 10 mL of unreacted sample, up to the mark, and replace the cap.



- Place the cuvette into the holder and close the lid.

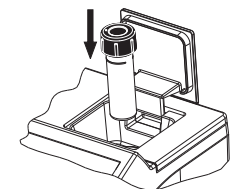

- Press the **Zero** key. The display will show “-0.0-” the meter is zeroed and ready for measurement.

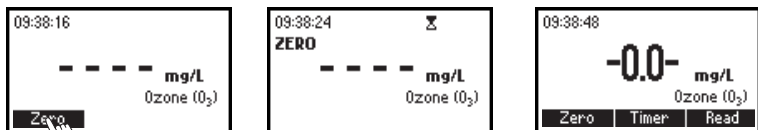

- Remove the cuvette.
- Add the content of one packet of HI 93757-0 Ozone Reagent. Replace the cap and shake gently for 20 seconds.
- Replace the cuvette into the holder and close the lid.
- Press **Timer** and the display will show the countdown prior to the measurement or, alternatively, wait for 2 minutes and press **Read**. When the timer ends the meter will perform the reading.

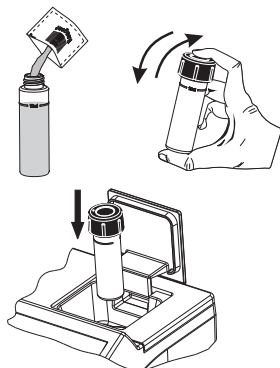

- The instrument displays concentration in **mg/L of ozone** (chlorine free samples only).



ADDITIONAL MEASUREMENT PROCEDURE

For samples containing chlorine

- Select the *Ozone* method using the procedure described in the *Method Selection* section (see page 15).
- Fill the cuvette with 10 mL of unreacted sample, up to the mark, and replace the cap.
- Place the cuvette into the holder and close the lid.

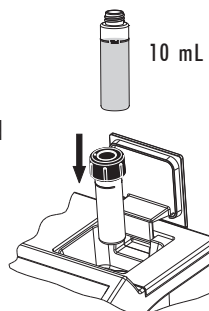

- Press the **Zero** key. The display will show “-0.0-” when the meter is zeroed and ready for measurement.

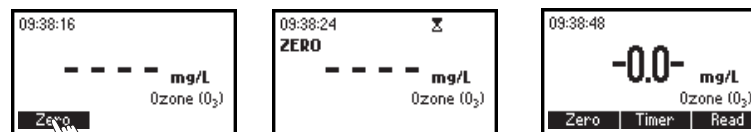

- Remove the cuvette.
- Add the content of one packet of the optional reagent HI93703-52-0 Glycine Powder. Replace the cap and shake gently until completely dissolved.
- Add the content of one packet of HI 93757-0 Ozone Reagent. Replace the cap and shake gently for 20 seconds.
- Replace the cuvette into the holder and close the lid.
- Press **Timer** and the display will show the countdown prior to the measurement or, alternatively, wait for 2 minutes and press **Read**. When the timer ends the meter will perform the reading.

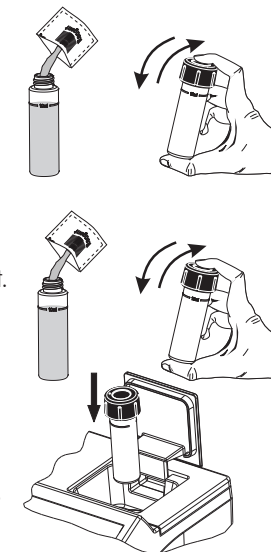

- The instrument displays a concentration value referring to chlorine interference. Subtract this value from the reading from the Standard Measurement Procedure: this will be the concentration in **mg/L of ozone** in the sample.

INTERFERENCES

Interference may be caused by: Bromine, Chlorine Dioxide, Iodine. Alkalinity above 250 mg/L CaCO₃ will not reliably develop the full amount of color or it may rapidly fade. To resolve this, neutralize the sample with diluted HCl. In case of water with hardness greater than 500 mg/L CaCO₃, shake the sample for approximately 2 minutes after adding the powder reagent.

pH

SPECIFICATIONS

Range	6.5 to 8.5 pH
Resolution	0.1 pH
Accuracy	±0.1 pH at 25 °C
Typical EMC	±0.1 pH
Deviation	
Light Source	Tungsten lamp with narrow band interference filter @ 525 nm
Method	Adaptation of the Phenol Red method. The reaction with the reagent causes a yellow to red tint in the sample.

REQUIRED REAGENTS

Code	Description	Quantity
HI 93710-0	Phenol Red Indicator	5 drops

REAGENT SETS

HI 93710-01 Reagents for 100 pH tests

HI 93710-03 Reagents for 300 pH tests

For other accessories see page 46.

MEASUREMENT PROCEDURE

- Select the *pH* method using the procedure described in the *Method Selection* section (see page 15).
- Fill the cuvette with 10 mL of unreacted sample (up to the mark) and replace the cap.
- Place the cuvette into the holder and close the lid.
- Press the **Zero** key. The display will show “-0.0-” when the meter is zeroed and ready for measurement.

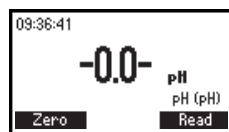
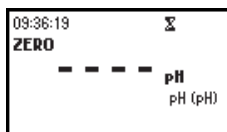
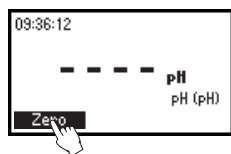
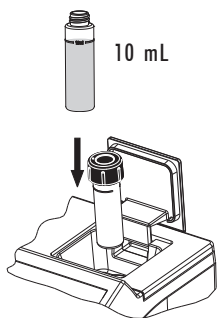

- Remove the cuvette and add 5 drops of HI 93710-0 Phenol Red Indicator. Replace the cap and mix the solution.

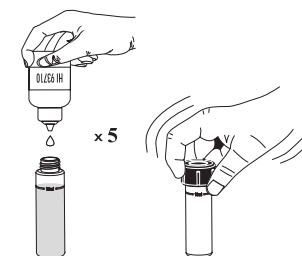

- Reinsert the cuvette into the instrument.

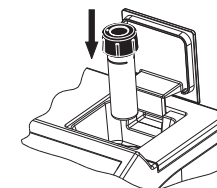

- Press the **Read** key to start the reading. The instrument displays the **pH value**.

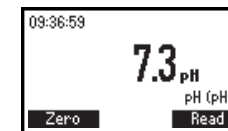
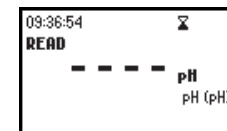
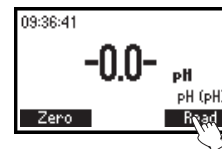

ERRORS AND WARNINGS

The instrument shows clear warning messages when erroneous conditions appear and when measured values are outside the expected range. These messages are described below.



No Light: The light source is not functioning properly.



Light Leak: There is an excess amount of ambient light reaching the detector.



Inverted cuvettes: The sample and the zero cuvettes are inverted.



Battery Low: The battery capacity is lower than 10%.



Light Low: The instrument cannot adjust the light level. Please check that the sample does not contain any debris.



Light High: There is too much light to perform a measurement. Please check the preparation of the zero cuvette.

DATA MANAGEMENT

The analyzed data can be managed using Hanna's product HI92000, Windows® Compatible Software.

	Date	Time	Conc.	Unit	Parameter	Absorbance	Instr. ID.	Instr. Serial No.
1	2007/06/19	10.04.12	0.95	mg/L	Free chlorine	0.4915167	0007	83414201XA6
2	2007/06/19	10.04.43	0.95	mg/L	Free chlorine	0.4919497	0007	83414201XA6
3	2007/06/19	10.05.03	0.96	mg/L	Free chlorine	0.4924213	0007	83414201XA6
4								
5								
6								
7								
8								
9								
10								
11								
12								
13								
14								
15								
16								
17								

STANDARD METHODS

Description	Range	Method
Alkalinity	0 to 500 mg/L	Colorimetric
Bromine	0.00 to 10.00 mg/L	DPD
Calcium Hardness	0 to 500 mg/L	Colorimetric
Chlorine, Free	0.00 to 5.00 mg/L	DPD
Chlorine, Total	0.00 to 5.00 mg/L	DPD
Copper, Free	0.00 to 5.00 mg/L	Bicinchoninate
Copper, Total	0.00 to 5.00 mg/L	Bicinchoninate
Cyanuric Acid	0 to 200 mg/L	Turbidimetric
Iron	0.00 to 5.00 mg/L	Phenantroline
Ozone	0.00 to 2.00 mg/L	DPD
pH	6.5 to 8.5 pH	Phenol Red

ACCESSORIES

REAGENT SETS

HI 93701-01	100 free chlorine tests (powder)
HI 93701-03	300 free chlorine tests (powder)
HI 93701-F	300 free chlorine tests (liquid)
HI 93703-52	Glycine Powder, Optional Reagent for 100 tests
HI 93711-01	100 total chlorine tests (powder)
HI 93711-03	300 total chlorine tests (powder)
HI 93701-T	300 total chlorine tests (liquid)
HI 93711-03	300 total chlorine tests
HI 93702-01	100 free copper tests
HI 93702-03	300 free copper tests
HI 93702T-01	100 total copper tests
HI 93702T-03	300 total copper tests
HI 93710-01	100 pH tests
HI 93710-03	300 pH tests
HI 93716-01	100 bromine tests
HI 93716-03	300 bromine tests
HI 93720-01	100 Ca hardness tests
HI 93720-03	300 Ca hardness tests
HI 93721-01	100 iron tests
HI 93721-03	300 iron tests
HI 93722-01	100 cyanuric acid tests
HI 93722-03	300 cyanuric acid tests
HI 93755-01	100 alkalinity tests
HI 93755-03	300 alkalinity tests
HI 93757-01	100 ozone tests
HI 93757-03	300 ozone tests

OTHER ACCESSORIES

HI 740226	5 mL graduated syringe
HI 731318	cloth for wiping cuvettes (4 pcs)
HI 731321	glass cuvettes (4 pcs)
HI 731325W	new cap for cuvette (4 pcs)
HI 740034	cap for 100 mL beaker (6 pcs)
HI 740036	100 mL plastic beaker (6 pcs)
HI 740038	60 mL glass bottle and stopper
HI 740142	1 mL graduated syringe
HI 740143	1 mL graduated syringe (6 pcs)
HI 740144	pipette tip (6 pcs)
HI 740157	plastic refilling pipette (20 pcs)
HI 740220	25 mL glass cylinders with caps (2 pcs)
HI 92000	Windows compatible software
HI 920013	PC connection cable
HI 93703-50	Cuvette cleaning solution (230mL)

WARRANTY

All Hanna Instruments meters are warranted for two years against defects in workmanship and materials when used for its intended purpose and maintained according to the instructions.

This warranty is limited to repair or replacement free of charge.

Damages due to accident, misuse, tampering or lack of prescribed maintenance are not covered.

If service is required, contact your dealer. If under warranty, report the model number, date of purchase, serial number and the nature of the failure. If the repair is not covered by the warranty, you will be notified of the charges incurred.

If the instrument is to be returned to Hanna Instruments, first obtain a Returned Goods Authorization Number from the Customer Service Department and then send it with shipment costs prepaid. When shipping any instrument, make sure it is properly packaged for complete protection.

To validate your warranty, fill out and return the enclosed warranty card within 14 days from the date of purchase.

Recommendations for Users

Before using these products, make sure that they are entirely suitable for your specific application and for the environment in which they are used.

Operation of these instruments may cause unacceptable interferences to other electronic equipments, this requiring the operator to take all necessary steps to correct interferences.

Any variation introduced by the user to the supplied equipment may degrade the instruments' EMC performance.

To avoid damages or burns, do not put the instrument in microwave ovens. For yours and the instrument safety do not use or store the instrument in hazardous environments.

Hanna Instruments reserves the right to modify the design, construction and appearance of its products without advance notice.

HANNA LITERATURE

Hanna publishes a wide range of catalogs and handbooks for an equally wide range of applications. The reference literature currently covers areas such as:

- Water Treatment
- Process
- Swimming Pools
- Agriculture
- Food
- Laboratory

and many others. New reference material is constantly being added to the library.

For these and other catalogs, handbooks and leaflets contact your dealer or the Hanna Customer Service Center nearest to you. To find the Hanna Office in your vicinity, check our home page at www.hannainst.com.



Hanna Instruments Inc.
Highland Industrial Park
584 Park East Drive
Woonsocket, RI 02895 USA

Technical Support for Customers

Tel. (800) 426 6287
Fax (401) 765 7575
E-mail tech@hannainst.com
www.hannainst.com

Local Sales and Customer Service Office

