

Operation Manual

SHC Series



INDEX

1. Safety precautions in handling, installation and usage	5
2. Product	9
3. Main feature	9
4. Screwdriver	10
4.1 Specification	10
4.2 Model	11
4.3 Dimension	12
5. Controller	14
5.1 Specification	13
5.2 Part and dimension	15
6. Installation	18
7. Operation	21
7.1 Front panel	21
7.2 Structure of the Mode	22
7.3 Parameter setting mode	23
7.4 Monitoring mode	25
7.5 RUN mode	26
7.6 Parameter setting and monitoring on Smart-Manager	29
7.7 Torque, Speed and Angle setting on front panel	30
7.8 Details of each parameter	31
7.9 Controller inspection period and trouble shooting	47
7.10 50pin I/O circuit	53
7.11 50pin I/O details	54
7.12 Error code output - error group and Output pin map	56
7.13 I/O timing chart	56

8. PC communication software, <i>Smart-Manager (for Windows)</i>	57
8.1 Software installation	58
8.2 Operation	58
8.3 SHC controller firmware upgrade	59
8.4 <i>Parameter setting on Smart-Manager</i>	60
1) Fastening setting	60
2) Profile of fastening process	61
3) Multi sequence setting	61
4) Driver ++ setting	63
5) Real time monitoring data output	64
6) Real time Torque / Speed curve monitoring	65
7) Alarm history	65
8.5 Com port and cable specification	66
1) RS-232C cable pin details	68
2) RS-485 cable pin details	68
3) RS-232C Baud rate change	69
8.6 SHC controller communication Protocol	
1) Protocol frame	68
2) Communication control letter	68
3) Command	68
4) Check sum(BCC)	69
5) Command details	69



1. Safety Precautions

This is CSD5 User Manual describes safety matters using the following marks. Safety marks deals with the important matters. If the following marks and contents of each mark are indicated in the contents of this user's manual, you must be fully aware of them and follow them.

Usage

WARNING



- Do not touch the inside of servo drive.
- Make sure that the servo drive and the motor are fully grounded.
- Completely discharged before handling after power off.
- Do not put excessive stress on the motor power and encoder cable.
- Never touch the revolving part of the motor during operation .

CAUTION



- Don't use the product near wet places, corrosive and inflammable materials.
- Operate the system with no load during pilot operation.
- Never touch the heat sink directly.

Storage

WARNING



- Do not store the product near wet places, rain, toxic gas or fluid.
- Keep the product out of the direct rays of the sun and store it within the storage temperature and humidity ranges.
- Avoid overloading if the product is stored in a warehouse.

Transportation

WARNING



- Do not carry the product by holding the cable and the motor shaft.

Installation and Wiring

WARNING



- Install a cooling fan to prevent excessive temperature increase. (Refer to the Chapter 2)
- Be careful not to wiring cables around the heat sink.

CAUTION



- Install drives with regular space (at least 10 mm) between them.
- Pay attention to the heat sink when wiring. (Refer to Chapter 2)

Maintenance and Repair

WARNING



- Do not disassemble or remodel the product. Any damage caused after the user disassembles or remodels the product will be excluded from the company's warranty.
- The company bears no responsibility for injuries or physical damage caused by remodeling of this product.
- Life-limited Parts by mechanical friction or heat requires regular . Refer to the Chapter 8.
- In case of a failure that cannot be dealt with, please contact the technical support team of manufacturer or after-sales service center.

Electric circuit diagram

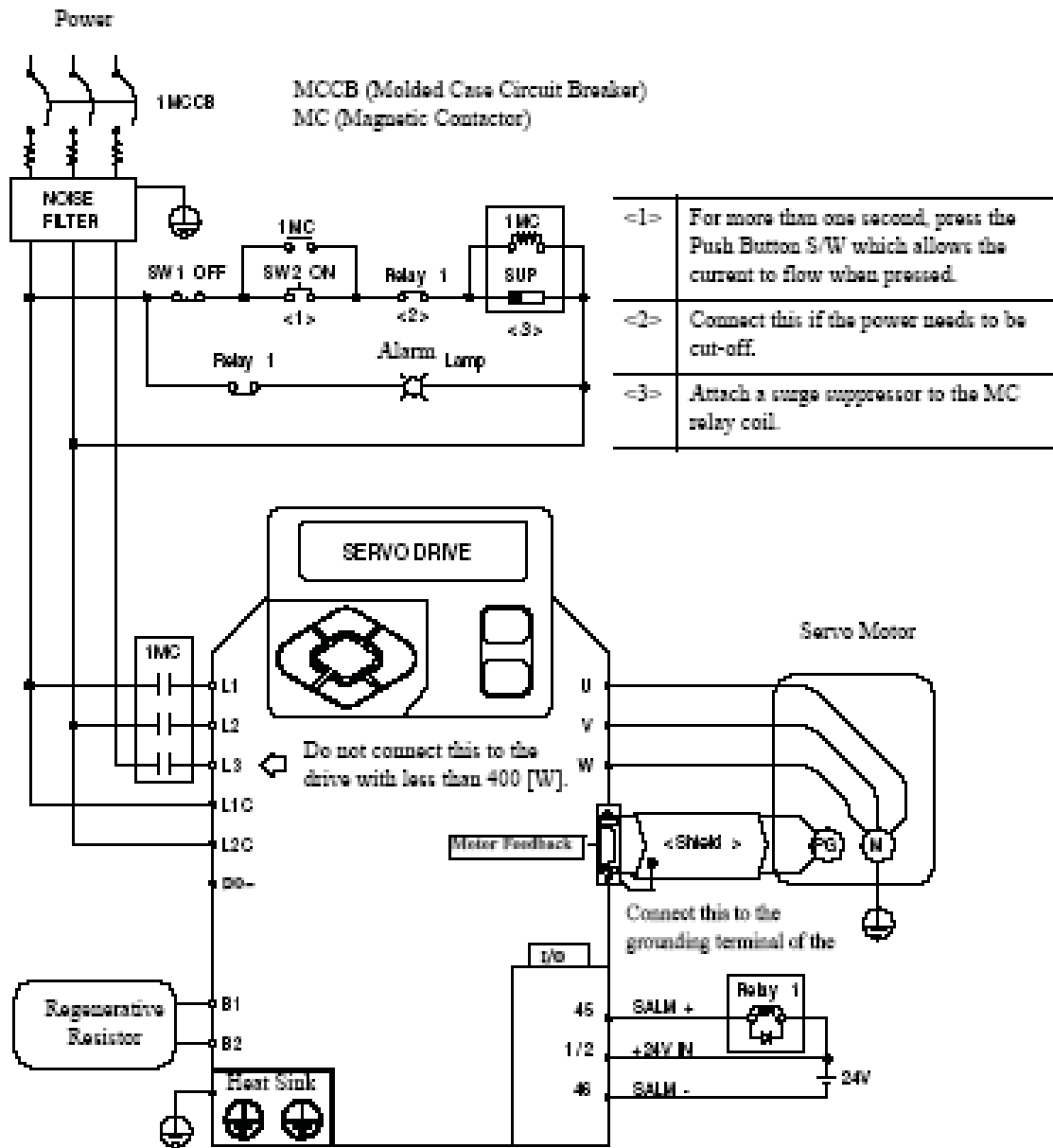

CAUTION



- Connect single-phase 220VAC power into controller for the 400 [W] or lower capacity. Do not use the terminal L3.

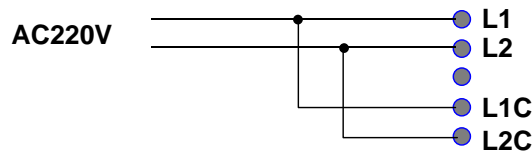

Socket and Lever

This section describes the usage of wiring socket and lever provided with servo drive.

- Connect only one wire at wire inlet of the socket.
- If the wire is pulled accidentally with an excessive force, rewire it properly.
- The peeled wire can be used. (Keep the length of the peeled core wire less than 8 [mm].)
- The use of phenol terminal is recommended for the reliability of wiring.
- Use a lever for wires provided with the product.
- The following figure shows the sequence of assembling wire at the socket.

1. As shown in the figure, insert lever in the socket and press it.
2. Insert wire into socket and release the lever.
3. Pull it slightly to check if the connection between the socket and wire is normal.

The thickness of wire allowed by the socket is shown below.

Prepare the Wires Strip of the Phenol Terminal Assemble the Socket

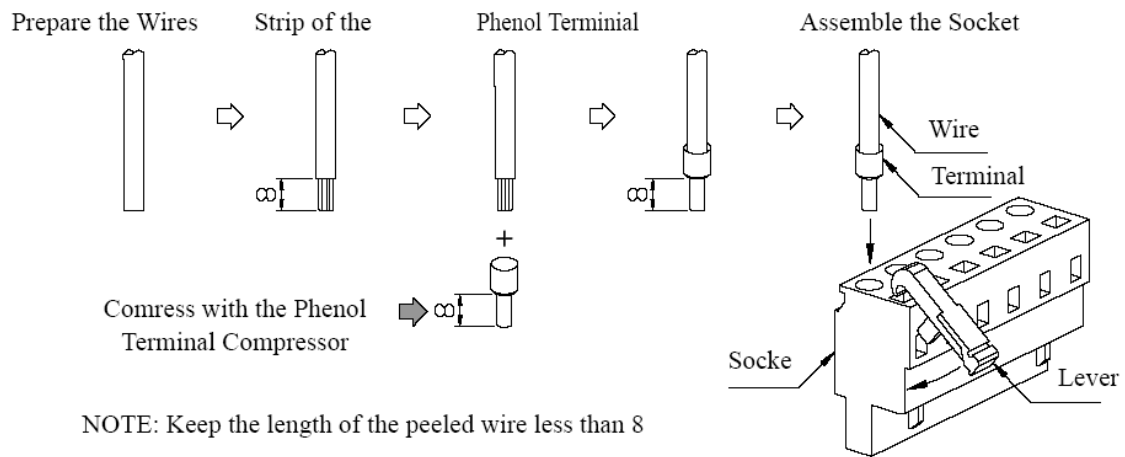

The thickness of wire allowed by the socket is shown below.

	Thickness of Wire
Twist	AWG20 ~ AWG14

Insert the wire completely. If peeled core wire is exposed, it may cause an electric shock. The lever is a small tool, used when wiring. Keep it for other wiring jobs.

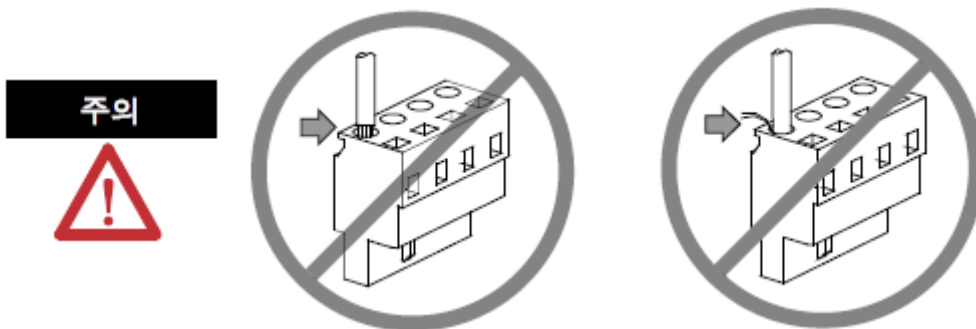

2. Products

It consist of AC Servo screwdriver, controller and cables(3m) as a complete system.

1) Standard item



SHC controller



Screwdriver



SH-Motor cable (3m)



SH-Encoder cable (3m)

2) Option accessories



RS-232C cable

3. Main feature

- 1) Digital torque set and save 8 memories
- 2) Long endurance, less noise and heat, and light weight screwdriver
- 3) Auto speed setting by torque setting
- 4) Monitoring fastening quality and count of screw numbers
- 5) Error information by code display
- 6) Easy parameter setting by Smart-Manager (PC software)
- 7) Real time torque data and curve display
- 8) Real time fastening data output (RS-232C)
- 9) Maintenance information and history memory
- 10) Firmware upgrade by Com port

4. Screwdriver

4.1 Specification

no	Item	Specification	Remark
1	Power	AC220V	
2	Motor	AC servo motor	
3	Dimension	refer to 4.3	
4	Torque	refer to 4.2	scale: 0.01 Kgf.cm
5	Speed	100 ~ 1,500 rpm +/- 5%	Auto speed by torque setting
6	Torque accuracy	10% in full scale	
7	Torque repeatability	+/- 3%	
8	Start by	I/O interface	
9	Cables	4P motor cable (3m) 5P encoder cable (3m) RS-232C cable (option)	

4.2 Model

Type	Torque	Speed (RPM)		Length	Weight	Bit size	Option		Controller to be used
		※Auto speed	Range				Vacuum pickup	Bit cushion	
SH030R010-A	0.5 - 2.5	410 - 1,000	100 - 1,000	173	0.63	1/4", HEX			SHC-50
SH030R010-A+V	0.5 - 2.5	410 - 1,000	100 - 1,000	222	0.66	1/4", HEX	○		SHC-50
SH030R010-A+C	0.5 - 2.5	410 - 1,000	100 - 1,000	173	0.63	1/4", HEX		○	SHC-50
SH030R010-A+VC	0.5 - 2.5	410 - 1,000	100 - 1,000	222	0.66	1/4", HEX	○	○	SHC-50
SH030R010-E	0.5 - 2.5	410 - 1,000	100 - 1,000	194.7	0.62	4mm, Round			SHC-50
SH030R010-E+V	0.5 - 2.5	410 - 1,000	100 - 1,000	209.4	0.66	4mm, Round	○		SHC-50
SH030R010-E+C	0.5 - 2.5	410 - 1,000	100 - 1,000	194.7	0.62	4mm, Round		○	SHC-50
SH030R010-E+VC	0.5 - 2.5	410 - 1,000	100 - 1,000	209.4	0.66	4mm, Round	○	○	SHC-50
SH050R010-A	0.8 - 4.5	300 - 1,000	100 - 1,000	187	0.72	1/4", HEX			SHC-50
SH050R010-A+V	0.8 - 4.5	300 - 1,000	100 - 1,000	236	0.75	1/4", HEX	○		SHC-50
SH050R010-A+C	0.8 - 4.5	300 - 1,000	100 - 1,000	187	0.72	1/4", HEX		○	SHC-50
SH050R010-A+VC	0.8 - 4.5	300 - 1,000	100 - 1,000	236	0.75	1/4", HEX	○	○	SHC-50
SH050R010-E	0.8 - 4.5	300 - 1,000	100 - 1,000	174.7	0.71	4mm, Round			SHC-50
SH050R010-E+V	0.8 - 4.5	300 - 1,000	100 - 1,000	223.4	0.8	4mm, Round	○		SHC-50
SH050R010-E+C	0.8 - 4.5	300 - 1,000	100 - 1,000	174.7	0.71	4mm, Round		○	SHC-50
SH050R010-E+VC	0.8 - 4.5	300 - 1,000	100 - 1,000	223.4	0.8	4mm, Round	○	○	SHC-50
SH100R010-A	1.5 - 9.0	365 - 1,200	100 - 1,200	201	0.83	1/4", HEX			SHC-100
SH100R010-A+V	1.5 - 9.0	365 - 1,200	100 - 1,200	250	0.84	1/4", HEX	○		SHC-100
SH100R010-A+C	1.5 - 9.0	365 - 1,200	100 - 1,200	201	0.83	1/4", HEX		○	SHC-100
SH100R010-A+VC	1.5 - 9.0	365 - 1,200	100 - 1,200	250	0.84	1/4", HEX	○	○	SHC-100
SH100R030-A	5 - 25	290 - 960	100 - 1,000	257.4	1.45	1/4", HEX			SHC-100
SH100R040-A	10 - 33	295 - 740	100 - 1,000	257.4	1.45	1/4", HEX			SHC-100
SH100R050-A	10 - 43	395 - 820	100 - 1,000	257.4	1.45	1/4", HEX			SHC-100
SH100R100-A	20 - 85	210 - 470	100 - 500	257.4	1.45	1/4", HEX			SHC-100
SH400R010-A	8 - 35	400 - 1,000	100 - 1,000	216.4	1.5	1/4", HEX			SHC-400
SH400R050-SQ	50 - 170	170 - 430	100 - 1,000	303	3.2	3/8", SQ Male			SHC-400
SH400R100-SQ	80 - 350	170 - 430	100 - 500	303	3.2	3/8", SQ Male			SHC-400
SH800R050-SQ	100 - 310	265 - 360	100 - 1,000	303.7	6.1	3/8", SQ Male			SHC-800
SH800R100-SQ	200 - 650	120 - 305	100 - 500	303.7	6.1	3/8", SQ Male			SHC-800

4.3 Dimension

■ SH030R010

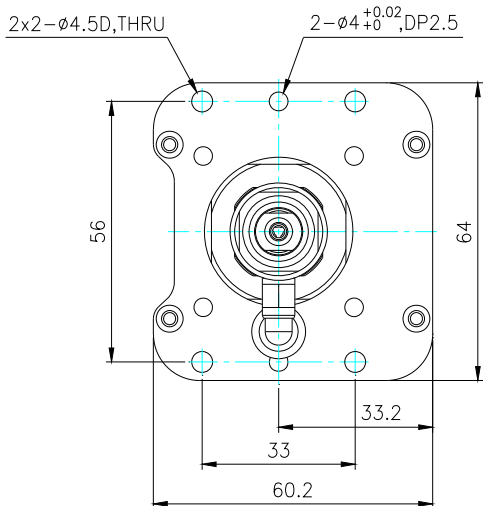
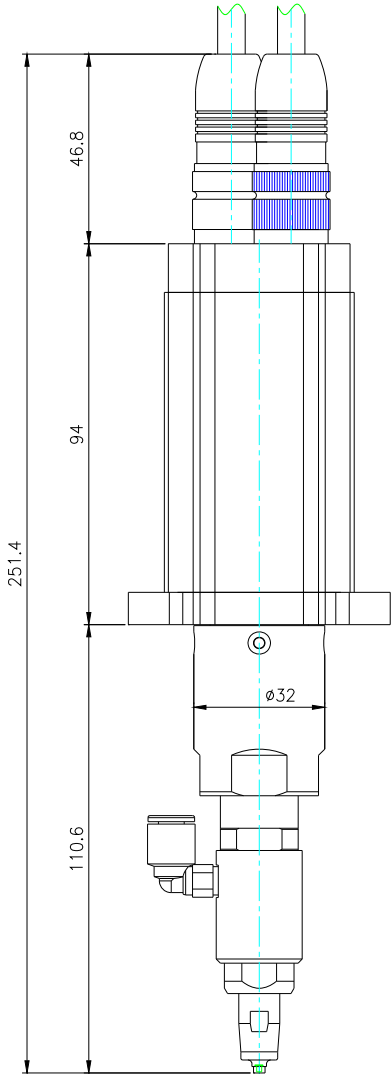

■ SH050R010 / SH100R010

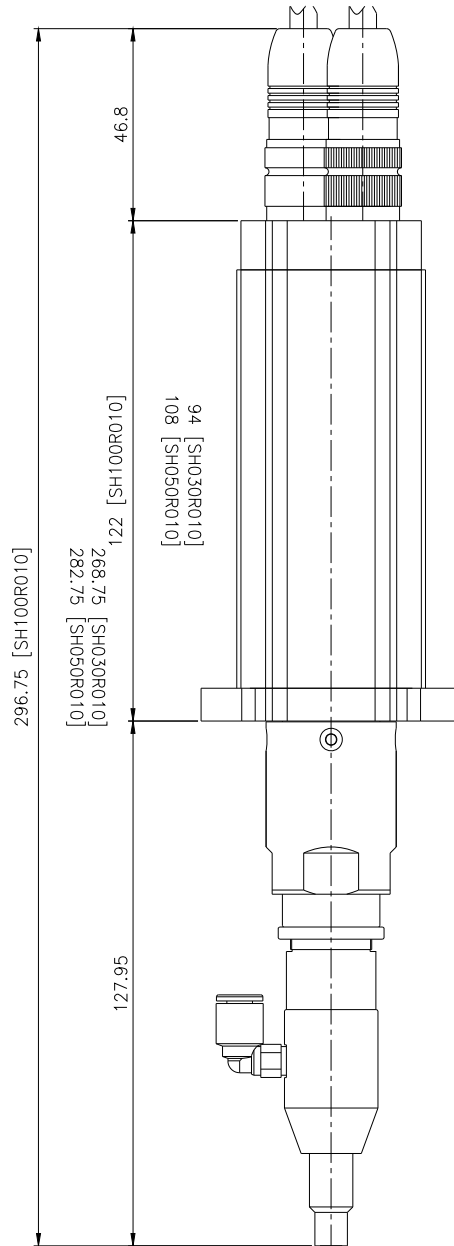

■ SH400R010

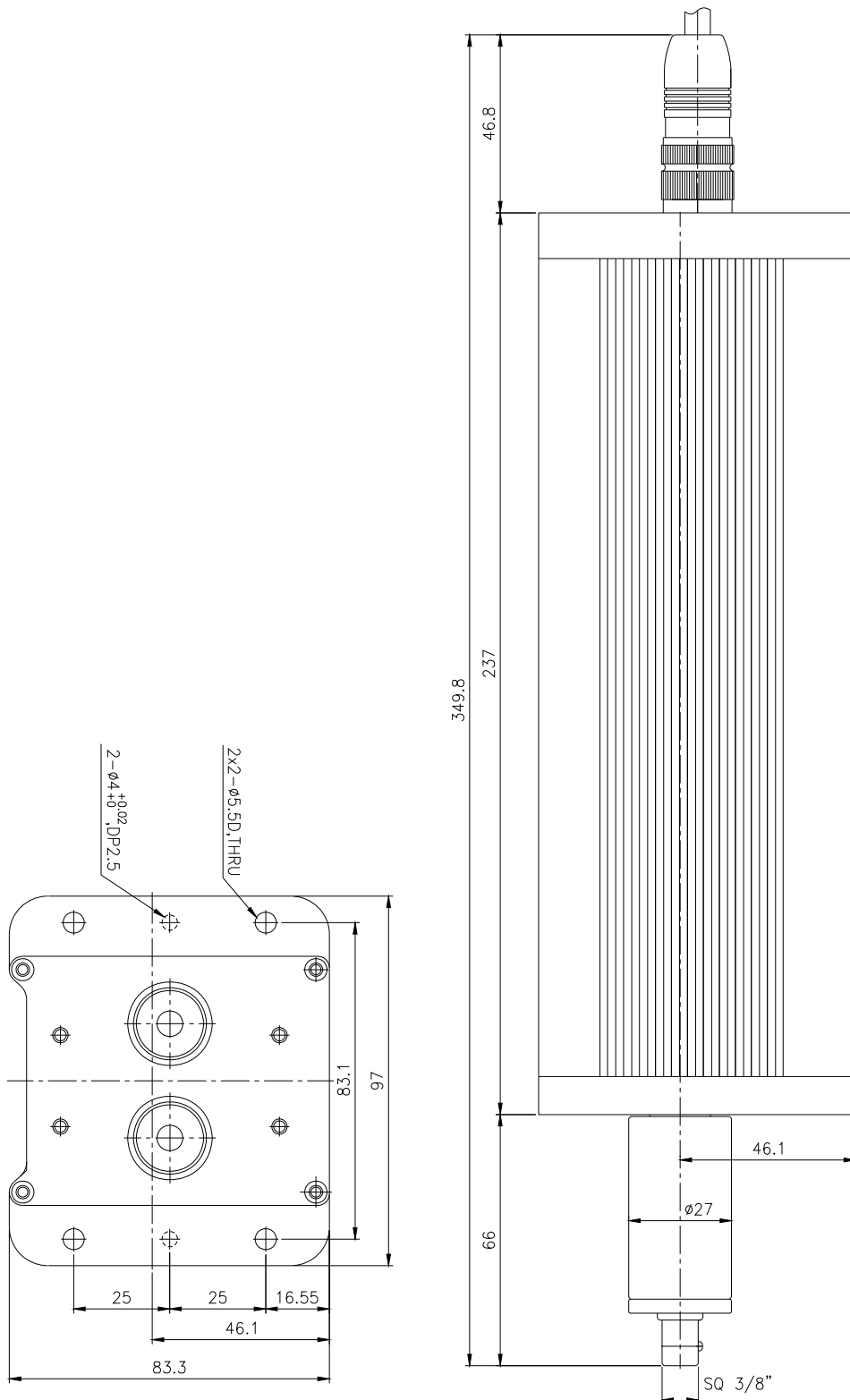

5. Controller

5.1 Specification

no	Item	Specification	
1	Input power	AC220V single phase, 50~60Hz (SHC-50,100,200,400)	
		AC220V 3 phase, 50~60Hz (SHC-800,1K,1.5K)	
2	Control Range	Torque	refer to screwdriver specification
		Speed	100 - 1,500 rpm
		Angle	0.1 turn scale
4	Parameters	Torque, speed & angle.. etc	
5	Preset # selecting	1) Front panel 2) 50P I/O interface	
6	Torque compensation	- 10% ~ +10%	
7	screwdriver recognition	Auto recognition when power ON	
8	Error display	by error code on FND	
9	Tightening quality control	NG / OK verification by Min, Max angle on the preset	
10	Parameter setting by	1) Front panel 2) PC software (Smart Manager)	

5.2 Controller part and dimension

5.2.1 part

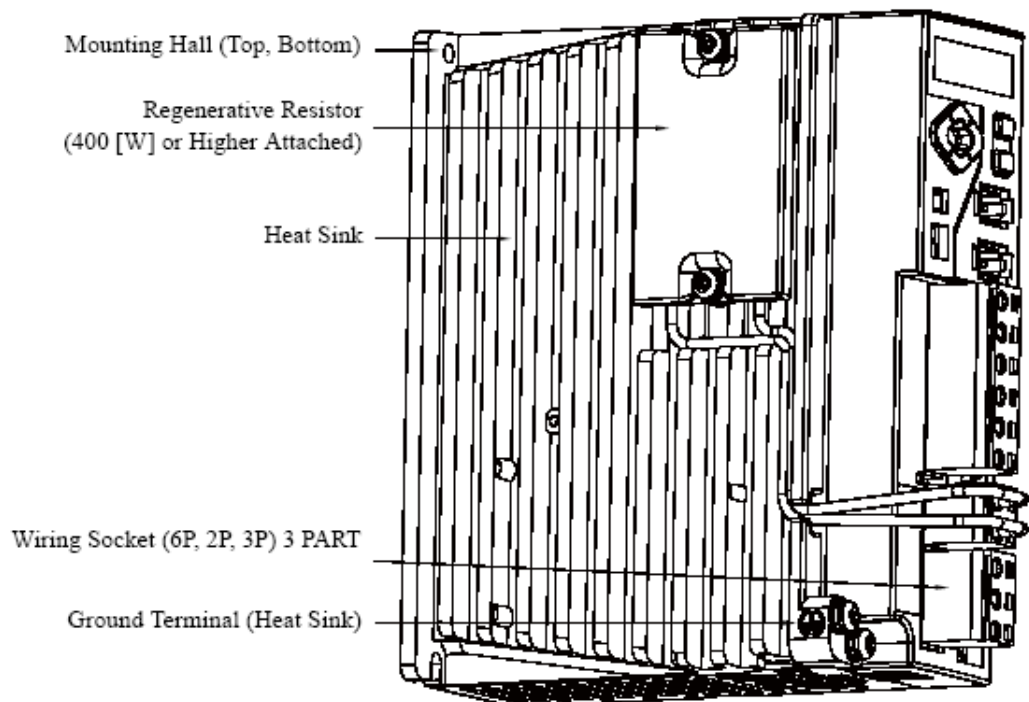
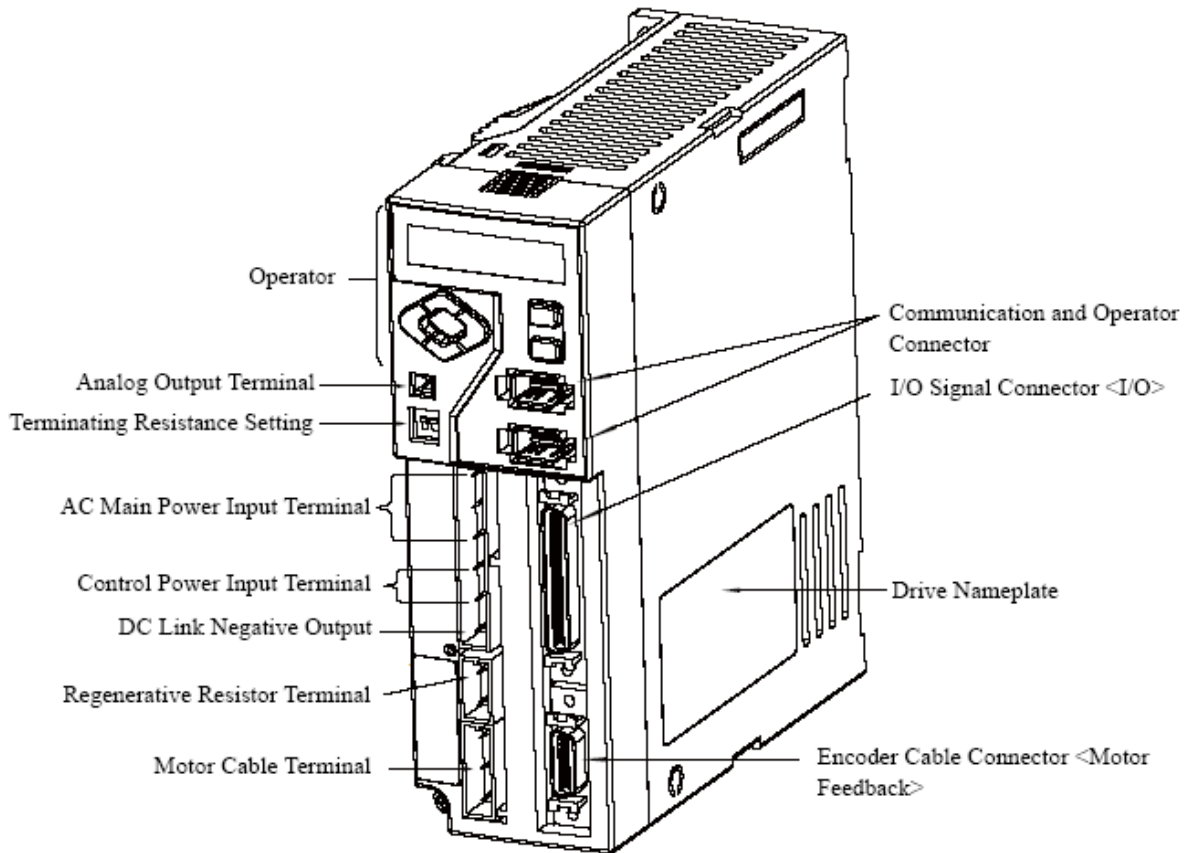

5.2.2 Dimensions

Model : SHC-50, SHC-100, SHC-200

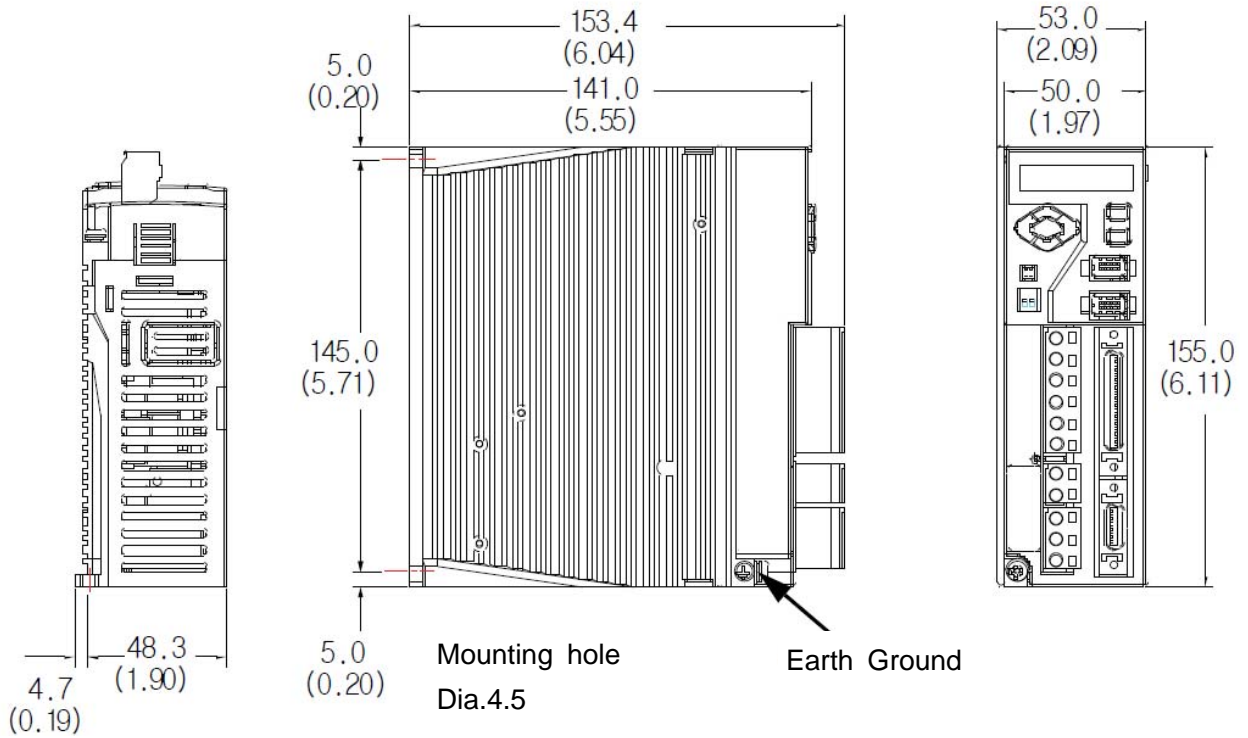

Unit : mm (inch)

Model : SHC-400

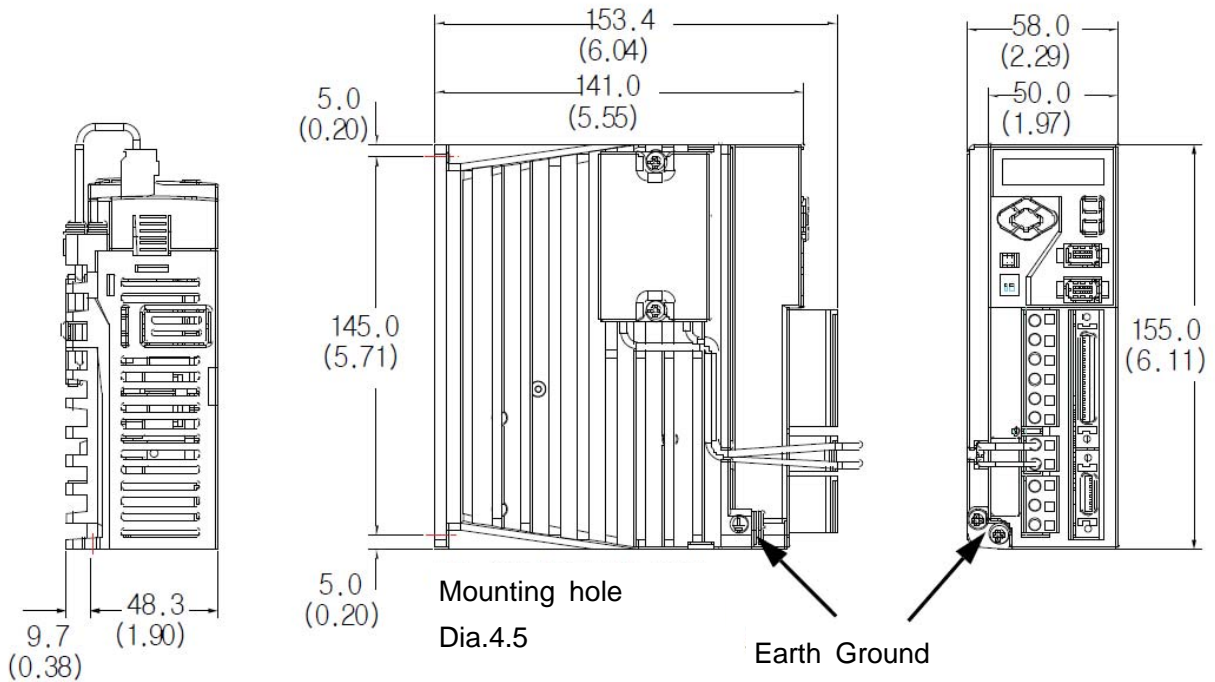

Unit : mm (inch)

Model : SHC-800, SHC-1K

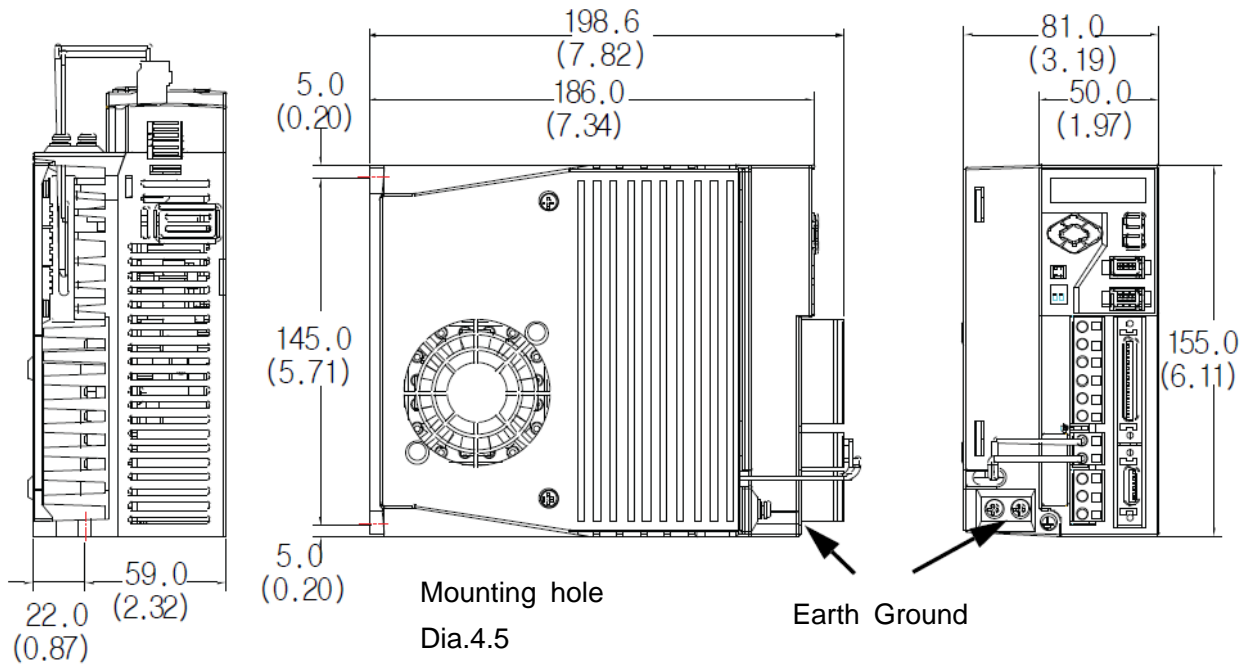

Unit : mm (inch)

6. Installation

This chapter describes matters to consider when installing the servo drive and the motor. Refer to the appendix for numerical data on the drive, motor, and various peripheral equipments necessary for the installation.

Precautions

Refer to the following figures when installing the servo drive. The most important thing to consider when installing the drive is the ambient temperature. Follow the operational temperature and mount the servo drive vertically.

Install the Servo Drive Vertically

Servo drive less than 400 [W] applies the natural convective cooling, and the servo drive with more than 0.8 [kW] uses the cooling fan. To increase the cooling efficiency, install it vertically.

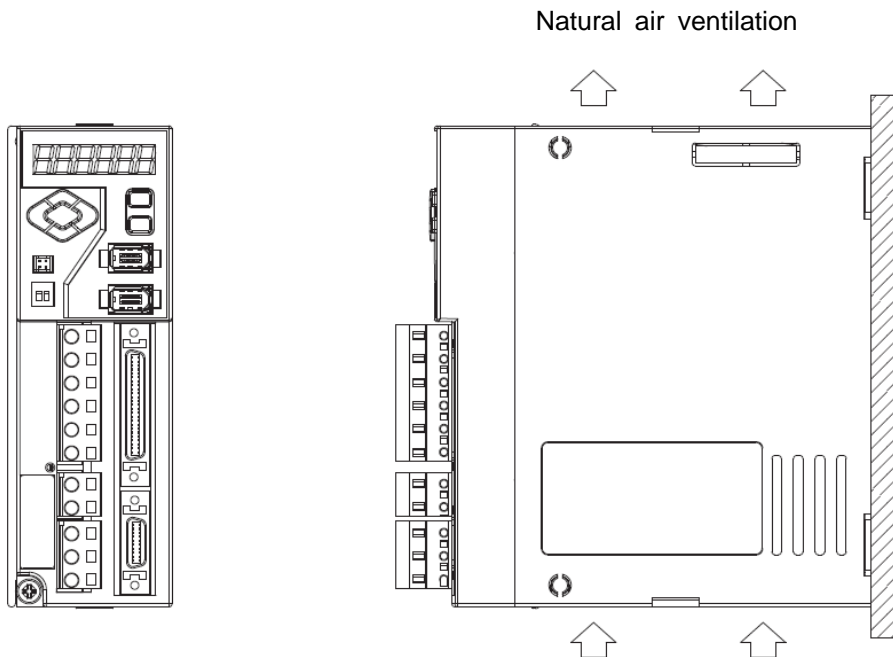

Mounting screw

- ▶ SHC-50, SHC-100, SHC-200, SHC-400 : Two screws (M4 x 10L)
- ▶ SHC-800, SHC-1K : Two screws (M5 x 10L)

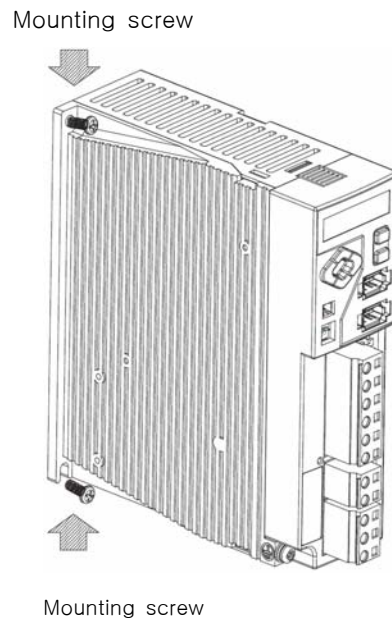

Cooling fan for multiple installation

If Two or more controller are installed together, the cooling fan is required to cool down the temperature inside of the room.

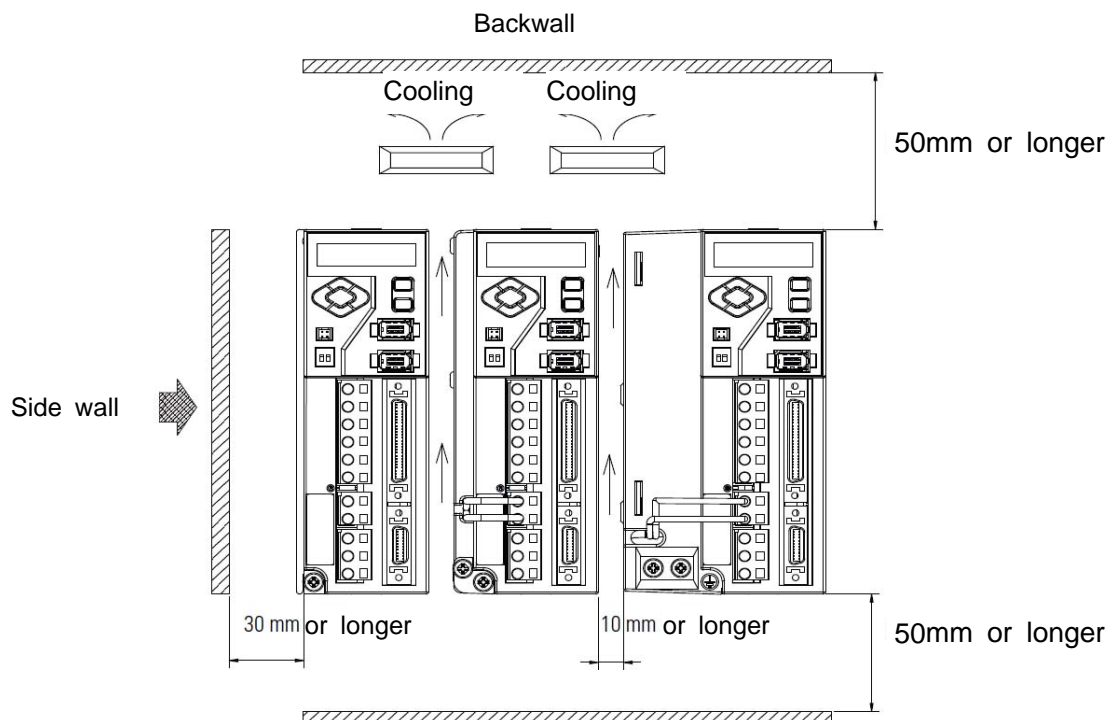

Use the Drive in a Clean Environment

Use the drive in a clean environment where there is no dust or humidity.

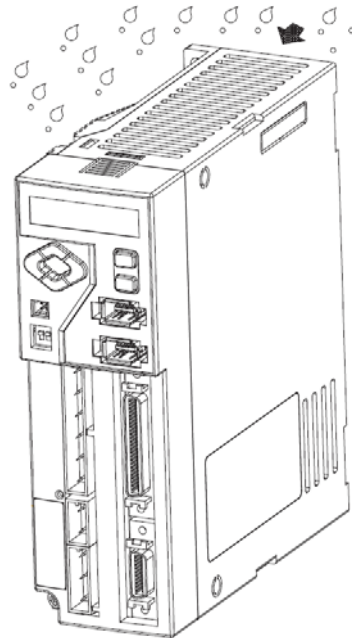

Ground

There is a grounding terminal at the bottom of the heat sink.

- 200 [W] or less: 1 mounting hole for M4 BOLT
- 400 [W] or above: 2 mounting holes for M4 BOLT

If not grounded, it may reduce the performance.

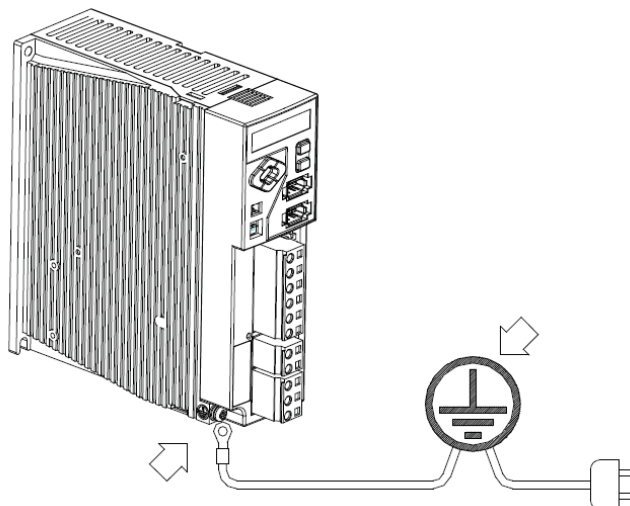

7. Operation

7.1 Front panel

The controller has a built-in operator for various status displays, parameter setting, operation command, and monitoring.

- ▶ Displays various contents with six 7-segment LED display.
- ▶ Provides all key manipulation function without a separate external operator.



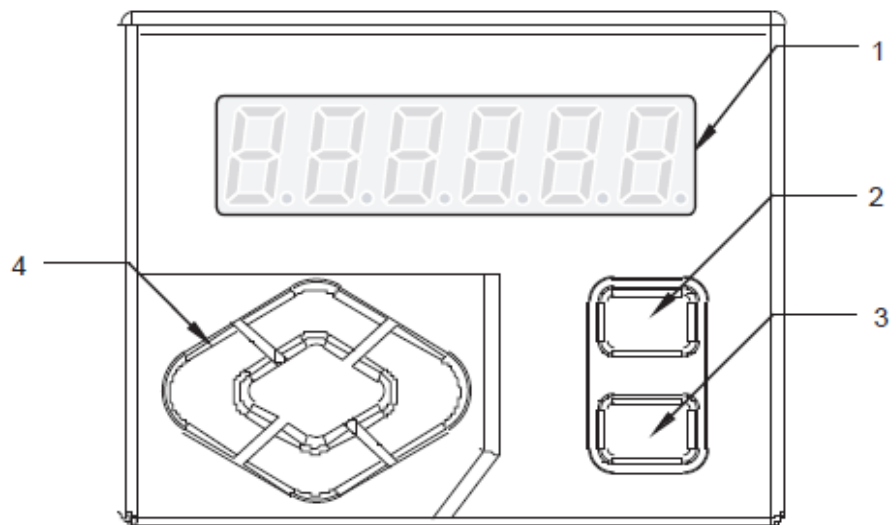



The following figure shows the front side of the operator on the servo drive.



No	Name	Function
1	7-Segment LED Display	Displays the status with 6-digit 7-segment LED display, sets parameter, commands operation and displays monitoring.
2	MODE/SET KEY	Key Enters display mode shift and parameter setting value.
3	ENTER KEY	Enters into each window after changes the display mode. Completes setting and exits from it. For Key Lock release, press the key for 2 sec.
4	Top, Bottom, Left/Right KEY	Moves the digit of 7-segment LED display and functions as the UP/DOWN of the number.

Icons for the Key Buttons

Icon is used in description throughout the manual. Thus, be fully aware of the shape, name and function of icons.

Key Button	Name	Function
	Up	- Increases and decreases the value
	Down	- Press and hold this icon to continuously increase/decrease the value
	Left	Shifts the digits
	Right	
	Direction	indicate up, down, left, right keys altogether
	MODE/SET	- Changes the mode - Saves the setting value - Start running
	ENTER	- To enter/exit setting window after changing the mode - Select setting value

※ Black key button represents that it is pressed.

7.2 Structure of the Mode

As shown in the figure below, the servo drive is divided into 5 types of control modes:

The mode displayed after the power ON is the status display mode. Mode is changed whenever the MODE/SET key is pressed. Be fully aware of the following 5 mode types and read the following.

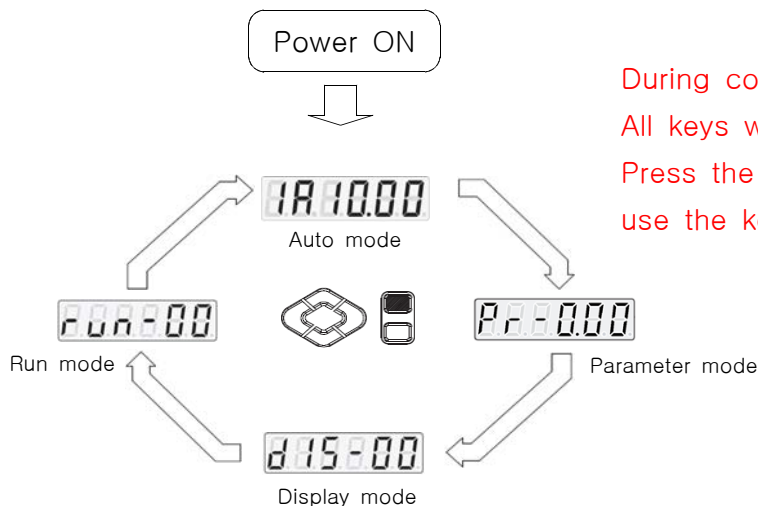

During communication on serial port,
All keys will be blocked.
Press the Enter key for 2 seconds to
use the key button again.

7.3 Parameter Setting Mode (Parameter mode)

The Parameter sets and saves various functions to make drive suitable for equipment. There is a parameter that can be always set regardless of the status of the controller, and those that must be in certain status of the drive when setting them.

7.3.1 Parameter group

P no.	Group	Description
000-007	Torque	Torque value for Preset #1-8
008-015	Speed	Speed value for Preset #1-8
016-023	Min. angle	Min. angle setting for OK/NG verification of Preset #1-8.
024-031	Max. angle	Max. angle setting for OK/NG verification of Preset #1-8.
032-039	Angle(turn) for free speed step	Screwdriver run with the speed set on P224 as per the angle value on P32 - 39. And it change to the original speed set on P11 - 18 "0" = Disable
100-120	I/O define	define I/O function and pin no.
200-213	Screw tightening	Screw tightening parameter setting
300-319	Controller setting	Controller parameter setting
400-419	Multi sequence	Multi sequence tightening program

7.3.2 Preset # and parameter group

The preset numbers from 1 to 8 are effected together with parameter 0~7 for torque, parameter 8~15 for speed, parameter 16~23 for min. angle, parameter 24~31 for max. angle, parameter 32~39 for free speed angle.

	1st data	2nd data	3rd data	4th data	5th data
Preset no.	Torque	Speed	Min angle	Max angle	Free speed Angle
1	P000	P008	P016	P024	P032
2	P001	P009	P017	P025	P033
3	P002	P010	P018	P026	P034
4	P003	P011	P019	P027	P035
5	P004	P012	P020	P028	P036
6	P005	P013	P021	P029	P037
7	P006	P014	P022	P030	P038
8	P007	P015	P023	P031	P039

The data from 1st and 2nd is always required to be set.

The data from 3rd to 6th are optional.

The 3rd, 4th and 5th data can be used for monitoring fastening quality or improving tightening time. They can be used or not.

7.4 Monitoring mode

Controller displays variable information in any status as below.

No.	Description and unit
dIS-00	Converted tightening torque (0.001)
dIS-01	Speed (rpm)
dIS-02	Gear ratio (0.01)
dIS-03	Current command[%]
dIS-04	Fastening turn (0.01 turn)
dIS-05	Fastening time (0.1 sec)
dIS-06	Loosening time (0.1 sec)
dIS-07	Pick current (mA)
dIS-08	Fastening angle (1도)
dIS-09	-
dIS-10	-
dIS-11	DC Link voltage
dIS-15	IO monitoring
dIS-16	Error display (1-8까지 저장)
dIS-17	Software Version
dIS-21	Drive Rated output power

Example of Key operation for monitoring

From Auto mode

1810.00

MODE/SET



0157.00



Use direction key to find dIS no from dis-00 to 17



0157.00



ENTER



123.456 Kgf.cm / converted torque

123456



Enter



0157.00



7.5 Run mode (Jog operation by Key button)

It is possible to start the screwdriver in run-00, reset the alarm in run-01 and initialize the controller parameters to the factory setting.

No.	Description
run-00	Start the screwdriver
run-01	Alarm Reset
run-02	User Parameter Initializing

► Run by Key button

※ Be sure that this run mode should not be during tightening process by PLC

Auto mode

MODE/SET to select Run mode display

Select run-00 by direction key

ENTER to confirm Run mode

MODE/SET to Jog ON

MODE/SET to Jog OFF

ENTER to confirm Jog OFF

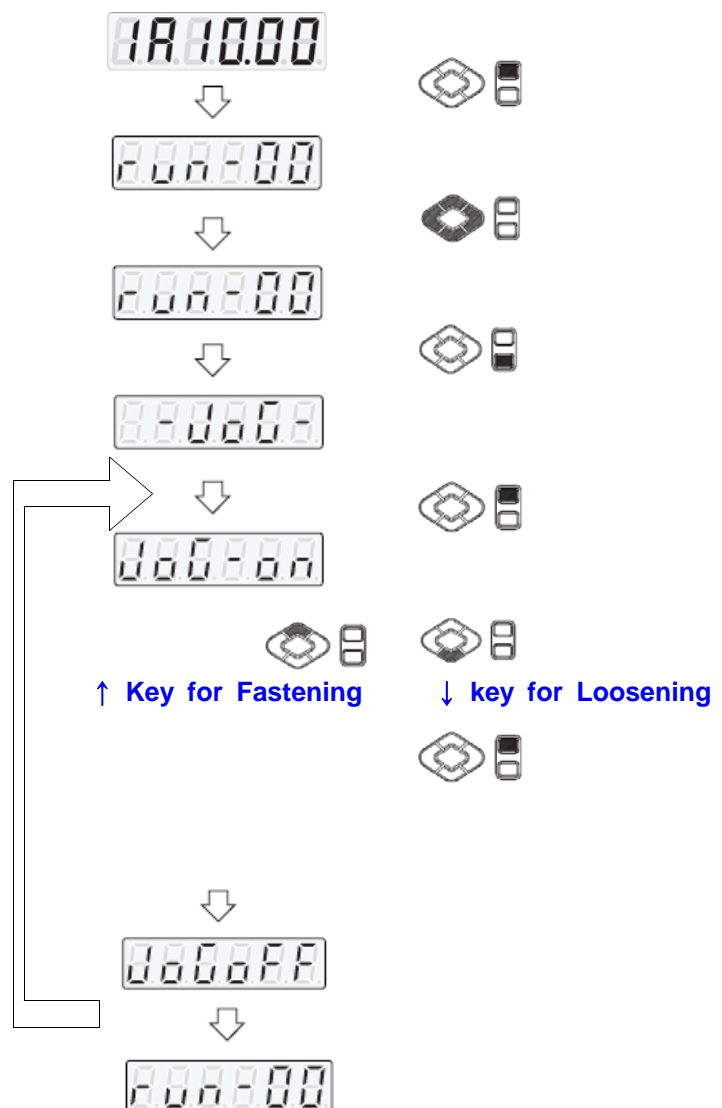

► Alarm Reset

※ Be sure that this run mode should not be during tightening process by PLC

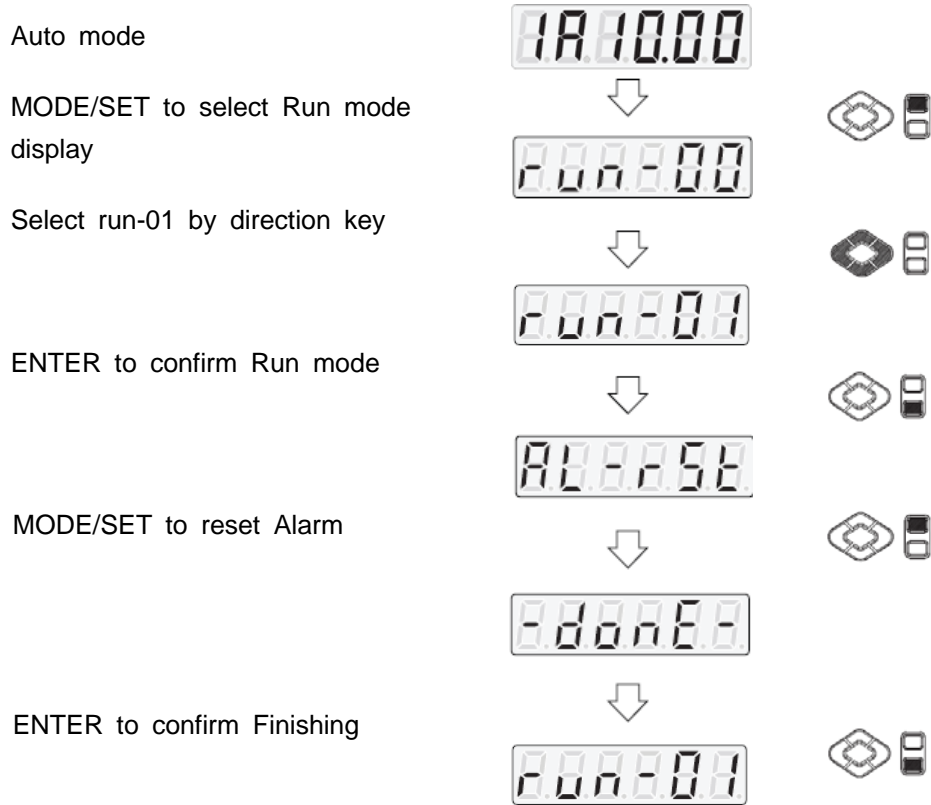

▶ User Parameter Initializing

※ Be sure that this run mode should not be during tightening process by PLC

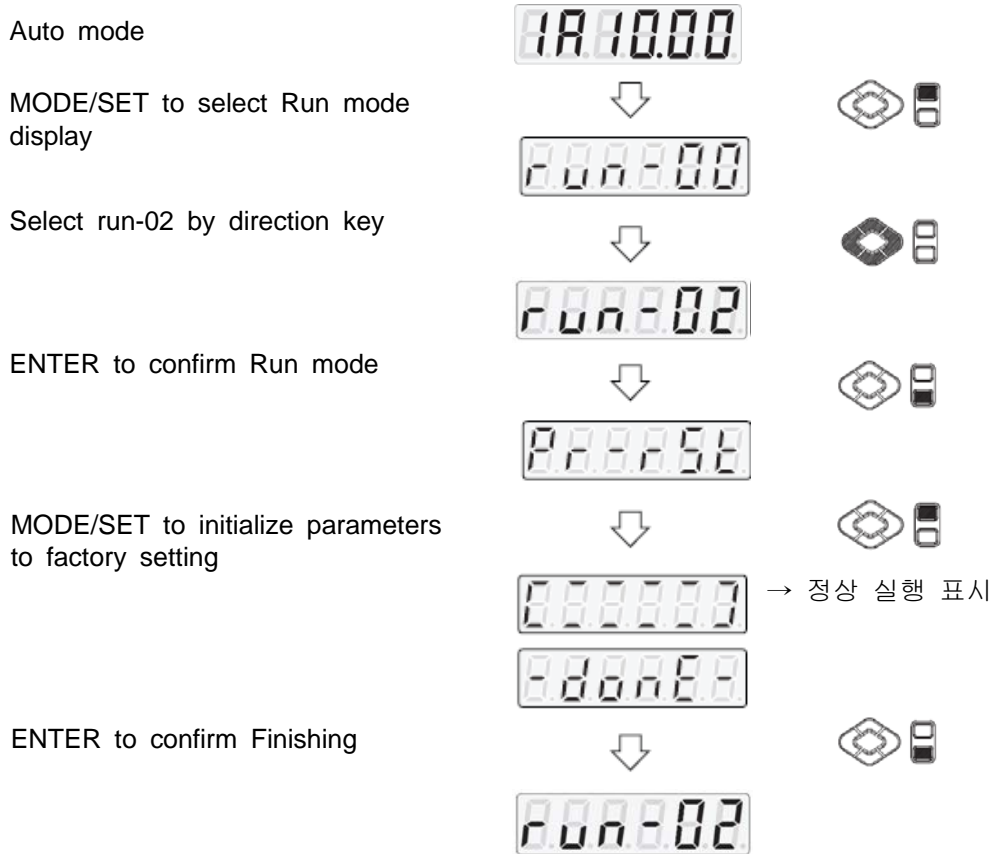

7.6 Parameter setting and monitoring by PC software - Smart Manager

Set torque, speed & angle on the PC program (Smart Manager-SHC) and upload to the SDC-24 controller, then parameters will be saved to the controller.

Please refer the details to the article 9.3 PC program, Smart-Manager..

[PC program : [Smart Manager](#)]

The screenshot displays the 'Smart Manager - SHC V0.06.5 E' software interface. The main window is titled 'Fastening Setting' and contains a table of parameters for 8 different fastening sequences. Below the table are four control panels for 'Torque Unit', 'Min Angle control', 'Max Angle control', and 'Auto change speed'. The status bar at the bottom shows 'COM7 : Open', 'Happy day !!!', and 'Log-in'.

PRE SET NO	TORQUE	SPEED (RPM)	MIN ANGLE (TURN)	MAX ANGLE (TURN)	FREE SPEED ANGLE(TURN)
1	5.00 P000	828 P008	0.0 P016	0.0 P024	0.0 P032
2	5.00 P001	828 P009	0.0 P017	0.0 P025	0.0 P033
3	5.00 P002	828 P010	0.0 P018	0.0 P026	0.0 P034
4	5.00 P003	828 P011	0.0 P019	0.0 P027	0.0 P035
5	5.00 P004	828 P012	0.0 P020	0.0 P028	0.0 P036
6	5.00 P005	828 P013	0.0 P021	0.0 P029	0.0 P037
7	5.00 P006	828 P014	0.0 P022	0.0 P030	0.0 P038
8	5.00 P007	828 P015	0.0 P023	0.0 P031	0.0 P039

Torque Unit (P301)

- Kgf.cm
- N.m [Caution]
- dN.m Change of unit will reset the parameter to factory default setting
- Lbf.in
- oz.in

After the change, you must power off and on.

Min Angle control (P312)

- No select
- No TorqueUp after the Min angle(turn)->Error E202
- TorqueUp before the Min angle(turn)->Error E203
- Both select

Max Angle control (P313)

- On the target Angel(turn)
- Stop and verify OK
- Stop and verify NG -> Error E201

* key in 'V' not to use

Auto change speed (P306)

- Enable
- Disable

7.7 Torque, Speed and Angle setting on front panel

Torque, Speed and Angle setting on front panel key is possible.

Example) Preset #1 - Torque 10Kgf.cm

※ Be sure that this run mode should not be during tightening process by PLC

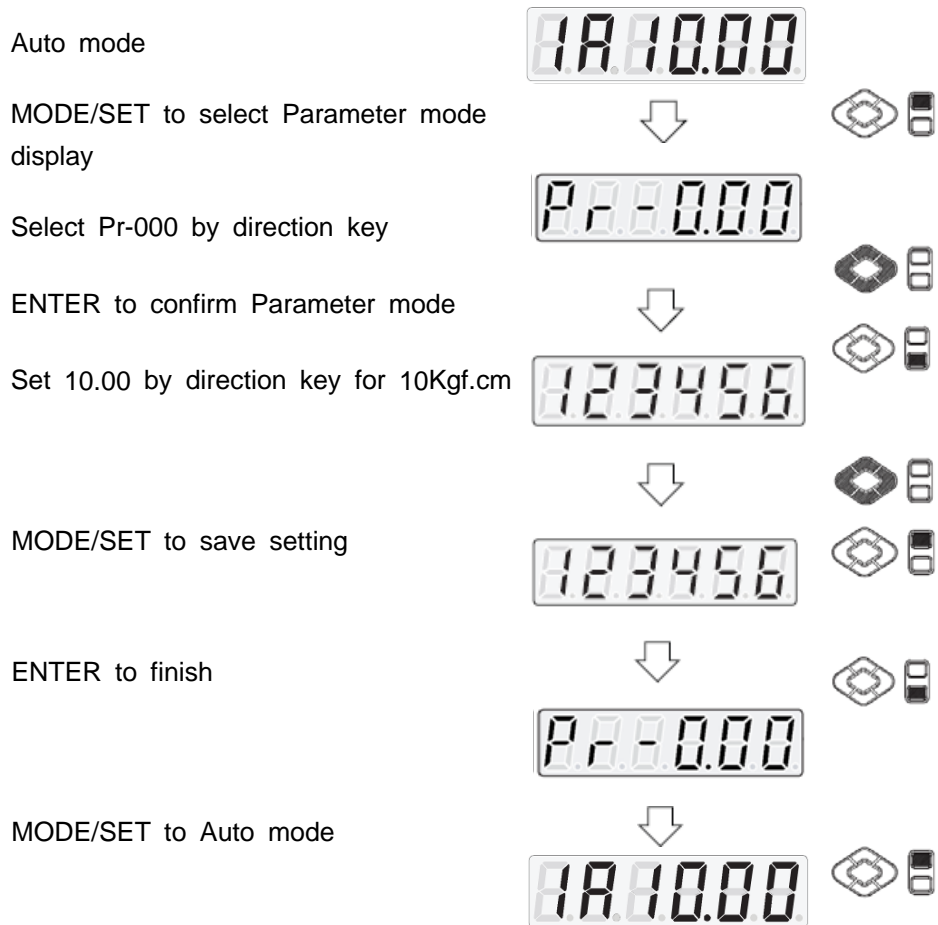

7.8 Details of each parameter numbers

1) Torque

Number	Unit	Range	Initial
P000~007	0.01 (Kgf.cm)		
Description	Each number from P000 to 007 contains the torque value for Preset # 1 to 8. The value of parameter 000 is the target torque saved in Preset # 1. Torque unit can be selected on P301		

2) Rotation Speed (Not recommended)

Number	Unit	Range	Initial
P008~015	1 rpm	depend on Model	
Description	<p>Each number from parameter 008 to 015 contains the speed value for Preset # 1 to 8. The value of parameter 008 is the target torque saved in Preset #1.</p> <p>Preset #1 have the torque of P000 and speed of P008.</p> <p>The speed is automatically changed on the torque setting. Changing speed to higher than auto setting is not recommended. Otherwise the torque can be over by the inertia.</p>		

3) Min. Angle control for Fastening Quality monitoring

Number	Unit	Range	Initial
P016~023	0.1 turn (36°)	0 ~ 30.0	0
Description	<p>Minimum angle can be set as a threshold point For fastening quality control by different setting on P312.</p> <p>"0" : No use "0.1~30.0" : Value of rotating angle (turn)</p> <p>P312 Min angle control setting should be one of below</p> <p>0 : No use 1 : No torque up after Min angle on P312 - E.202 2 : Torque up before Min angle on P312 - E.203 3 : Both (1+2)</p> <p>If the driver stop without torque up after the min angle, it provide fastening NG output signal with the error code E.202. It is most serious mistake by operator which is open found but difficult to be recognized..</p> <p>If the driver stops without torque up before the preset turn, it does not provide fastening NG. Because it is very common operating together with screw feeder.</p> <p>If the driver stop with torque up before the min angle, it provide fastening NG output signal with the error code E.203. It is useful to detect the wrong aligned, engaged screw or floating screws</p>		

4) Max Angle control

Number	Unit	Range	Initial
P024~031	0.1 turn (36°)	0 ~ 30.0	0
Description	<p>"0" : No use "0.1~30.0" : Value of rotating angle (turn)</p> <p>Function #1 Angle control stop and verify OK</p> <p>P313 Max angle control setting should be " 0 " : Stop and verify OK</p> <p>The driver stops at the set turn(angle) and provide fastening OK output signal. If the load reach to the target torque, it stops immediately even before the set turns (angle), and provide Torque-up and Fastening OK output signal together.</p> <p>For example, It have 6.0Kgf.cm in P003, 500rpm in P011 and 5 turns in P027, the driver will run with 500 rpm and stop at 5 turns (1800 degree). But if the driver reach to 6.0 Kgf.cm of the target torque before 5 turns, it will stop immediately at any turn.</p> <p>Function #2 Limit of Fastening angle for NG detection</p> <p>P313 Max angle control setting should be " 1 " : Stop and verify NG (E.201)</p> <p>If there is no torque up until the set angle(turn), it stop and provide NG output signal with the error code E.201. This function is useful to protect the screw which is continuously running around the screw hole without engaging.</p> <p>The latest fastening angle(turn) can be monitored on the FND display of front panel by display mode(dis-04)</p>		

5) Free speed angle

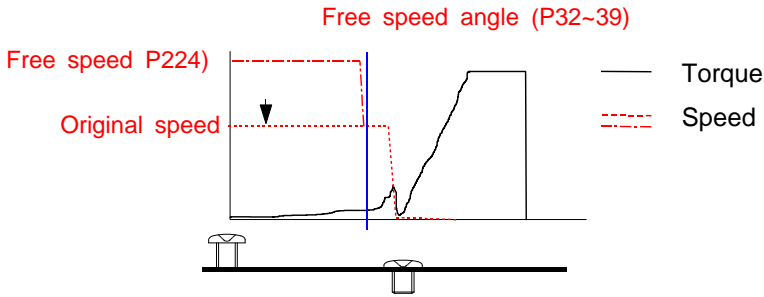
Number	Unit	Range	Initial
P032~039	0.1 turn (36°)	0 ~ 100.0 turn	0
Description	<p>If tightening time is too much long by the low speed for low torque setting, tightening time can be decreased by free speed setting. The free speed is just run down speed before screw seating point in a set angle.</p> <p>So there are two different speed steps.</p> <ul style="list-style-type: none"> - 1st step : free speed (set on P224) from starting to the set angle on P32 to 39 - 2nd step : original speed that is selected automatically by torque setting. <div style="text-align: center;">  <p style="text-align: center;">Free speed angle (P32~39)</p> <p>Free speed P224</p> <p>Original speed</p> <p>— Torque</p> <p>- - - Speed</p> </div> <p>"0" : No use "0.1~100.0" : Turn</p> <p>* The free speed angle should be 2 turn less than the screw seating point.</p> <p>* The speed setting on P224 works for all P32-P39.</p>		

6) Torque control profile setting (P200~210)

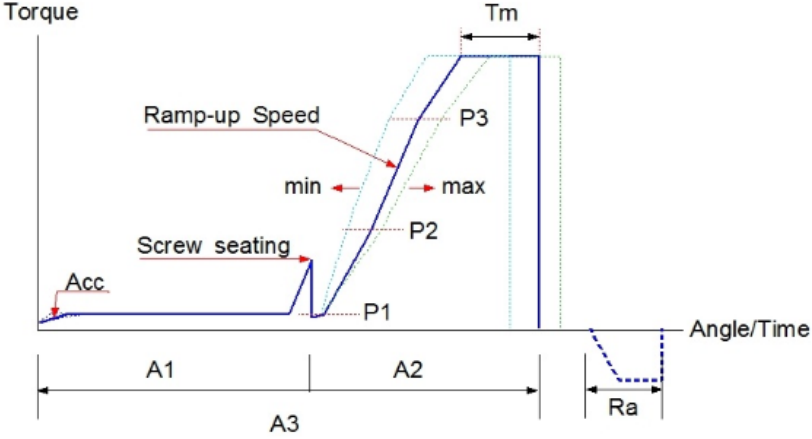
Number	Unit	Range	Initial
P200~210			0
Description	<p>There are parameters related with torque control profile as below</p> <p>A1 (Speed primary) : Speed is controlled with the target setting, torque is monitored until the monitored torque reaches to the set torque (percentage setting on P200) - Screw Seating Point</p> <p>A2 (Torque primary) : Motor stops at Screw seating Point, and control motor current to target setting (target torque) with limited speed.</p> 		

Description	<p>P200 Screw Seating Point (Factory setting : 30 %) Setting : 10 ~ 80 % of the target torque</p> <p>P201 P1 setting in A2 process (Factory setting : 40 %) Setting : 10 ~ 60 % of the target torque</p> <p>P202 P2 setting in A2 process (Factory setting : 60 %) Setting : 40 ~ 80 % of the target torque</p> <p>P203 P2 setting in A2 process (Factory setting : 80 %) Setting : 60 ~ 95 % of the target torque</p> <p>P204 Ramp up speed setting in A2 process with percentage of the target speed (Factory setting : 50 %) Setting : 10 ~ 100 % of the target torque</p> <p>P205 Torque ramp up time setting (Factory setting : 100 mS) Setting : 100 ~ 300 mS</p> <p>P206 Start point of ramp up speed on P204 Selecting : P1, P2, or P3 (Factory setting : P1)</p> <p>P207 Target torque holding time (Tm) Setting : 10 ~ 200 mS (Factory setting : 20 mS)</p> <p>P208 Auto reverse angle setting after torque holding process for bind screw releasing (Factory setting : 0) Setting : 0 ~ 100° (0 = No use)</p> <p>P209 Angle limit during torque Holding(Tm) (E.208) (Factory setting : 0) Setting : 0 ~ 360° (0 = No use)</p> <p>P210 Angle limit during Ramp-up process (E.207) (Factory setting : 0) Setting : 0 ~ 10 turns (0 = No use)</p>
-------------	---

7) Motor acceleration

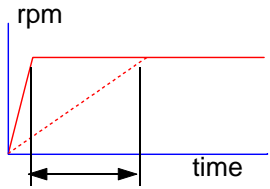
Number	Unit	Range	Initial
P211	10ms	10 ~ 200	100
Description	<p>The motor increase the rotation speed up to the target in the set time. It works for all preset #.</p> 		

8) Controller model reading (for internal information)

Number	Unit	Range	Initial
P300			
Description	Any setting is not allowed. Information for just reading		

9) Torque Unit

Number	Unit	Range	Initial
P301		0 ~ 4	0
Description	<p>It selects one of the torque units below ; "0" : Kgf.cm "1" : N.m "2" : cN.m "3" : lbf.in "4" : Ozf.in</p> <p>[Caution] Change of unit will reset every parameter to factory initial setting. The torque unit should be selected first before parameter setting</p>		

10) Screw type (Clockwise or Counter-clockwise)

Number	Unit	Range	Initial
P302		0 ~ 1	0
Description	It selects one of the screw type below ; "0" : Clockwise "1" : Counter-clockwise The initial value is "0" for "Clockwise"		

11) FND Display type

Number	Unit	Range	Initial
P303		0 ~ 3	1
Description	One of 4 types of display can be selected. "0" : Preset no. + Speed "1" : Preset no. + Torque [Stop] ↔ Preset no. [Running] "2" : Fastening Torque [Stop] ↔ Preset no. [Running] "3" : Converted torque [Stop] ↔ Preset no. [Running]		

12) Auto fastening data output

Number	Unit	Range	Initial
P304		0 ~ 1	0
Description	Monitoring data can come out automatically through RS-232 without data request command protocol when "1" is selected on P304 0 : Smart Manager 1 : Auto output Enable		

13) Torque compensation

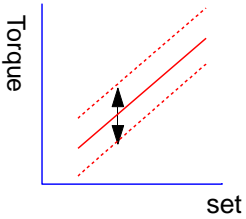
Number	Unit	Range	Initial
P305	1 %	90 ~ 110%	100
Description	<p>Output torque can be decreased or increased between -10% to +10% for each preset #.</p> <p>This torque tuning value is saved in controller, not in driver.</p> <p>Be careful tuning value when replace the screwdriver.</p> 		

14) Auto speed by torque setting

Number	Unit	Range	Initial
P306		0 or 1	1
Description	<p>The speed setting is automatically selected by program according to the torque setting.</p> <p>"0" : Disable "1" : Enable</p>		

15) Initial Loosening speed

Number	Unit	Range	Initial
P307	rpm	10 ~ 200	100
Description	<p>Initial speed for 0.5 turn of reverse is selectable.</p> <p>Setting : 10 ~ 200 rpm</p>		

16) Time limit for fastening, Loosening and motor stall

Number	Unit	Range	Initial
P308~309	0.1 sec	0 ~ 600	100 (10.0 sec)
Description	<p>It prevent the continuous running over the preset time in direction of fastening and loosening for safety operation. The driver stops automatically at the preset time and provide the pattern NG with the error code belows;</p> <p>P308 : Limit of fastening run time error code - E.204 P309 : Limit of loosening run time error code - E.205 Initial value = 10.0 sec</p> <p>Also it prevent the continuous time going against the motor stall for over heat protection.</p> <p>P314 : Limit of motor stall time error code - E.206 Initial value = 0.5 sec</p>		

17) Error display time setting

Number	Unit	Range	Initial
P310	0.1 sec	0 ~ 10	0
Description	<p>Error display and reset after the below set time</p> <p>"0" : Manual reset by RESET button "1 ~10.0 sec" : Auto reset after set time</p>		

18) P016~023 Min. Angle setting and NG type selecting

Number	Unit	Range	Initial
P312		0 ~ 3	0
Description	<p>Select one of following type of NG with Min. angle setting on P016~023</p> <p>"0" : No use</p> <p>"1" : No Torque-up NG after Min. angle. (E.202)</p> <p>"2" : Torque up NG before Min. angle (E.203)</p> <p>"3" : Combined "1" and "2"</p> <p>** Setting angle "0" means no use, too</p>		

19) P024~031 Max Angle setting and OK/NG verification

Number	Unit	Range	Initial
P313		0 ~ 1	0
Description	<p>Motor stops at the set Max angle, and verify as one of below</p> <p>"0" : OK</p> <p>"1" : NG and display Error code E.201</p> <p>** Max angle setting "0" means no use of this feature</p>		

20) 풀림 동작시 모터 **stall** 설정

Number	Unit	Range	Initial
P314	0.1 sec	0 ~ 1	0.5
	Limit of motor stall time for loosening error code - E.206		

21) E-stop setting

Number	Unit	Range	Initial
P315		0 ~ 1	0
<p>In order to use E-Stop feature, select Enable on P315 with E-Stop wiring connection. E-Stop wiring connection should be N.C</p>			

22) Free reverse angle setting

Number	Unit	Range	Initial
P316	0.1 turn	0 or 10.0	0
Description	<p>Screwdriver start to run in reverse direction in the angle of P316, and change rotation to forward direction to tighten screw. It can improve screw engaging into the screw hole.</p>		

23) Free reverse angle Enable/Disable setting

Number	Unit	Range	Initial																								
P317		0 or 255	0																								
Description	<p>It select the preset # to use the Free reverse angle on P316 as below.</p> <table border="1" style="margin-left: 40px;"> <thead> <tr> <th>Numeric code</th> <th>Preset #</th> </tr> </thead> <tbody> <tr> <td>1</td> <td>Preset #1</td> </tr> <tr> <td>2</td> <td>Preset #2</td> </tr> <tr> <td>4</td> <td>Preset #3</td> </tr> <tr> <td>8</td> <td>Preset #4</td> </tr> <tr> <td>16</td> <td>Preset #5</td> </tr> <tr> <td>32</td> <td>Preset #6</td> </tr> <tr> <td>64</td> <td>Preset #7</td> </tr> <tr> <td>128</td> <td>Preset #8</td> </tr> <tr> <td>3</td> <td>Preset #1 & 2 (1 + 2)</td> </tr> <tr> <td>98</td> <td>Preset #6 & 7 (32 + 64)</td> </tr> <tr> <td>148</td> <td>Preset #3, 5 & 8 (4 + 16 + 128)</td> </tr> </tbody> </table> <p>To select several presets, add all numeric code for them.</p>			Numeric code	Preset #	1	Preset #1	2	Preset #2	4	Preset #3	8	Preset #4	16	Preset #5	32	Preset #6	64	Preset #7	128	Preset #8	3	Preset #1 & 2 (1 + 2)	98	Preset #6 & 7 (32 + 64)	148	Preset #3, 5 & 8 (4 + 16 + 128)
Numeric code	Preset #																										
1	Preset #1																										
2	Preset #2																										
4	Preset #3																										
8	Preset #4																										
16	Preset #5																										
32	Preset #6																										
64	Preset #7																										
128	Preset #8																										
3	Preset #1 & 2 (1 + 2)																										
98	Preset #6 & 7 (32 + 64)																										
148	Preset #3, 5 & 8 (4 + 16 + 128)																										

24) Free speed setting for P32~39

Number	Unit	Range	Initial
P318	rpm	0 ~ max speed	-
Description	Speed value for free speed step. It works for P32 to 39.		

25) Packet setting in serial communication for PLC

Number	Unit	Range	Initial
P319		0 , 1	0
저장내용	Add suffix "ETX" (0X03) in every sending packet. ETX can be recognized as a EVENT to proceed the one block of packet in PLC. 0 : Disable 1 : Enable		

26) Driver ID select

Number	Unit	Range	Initial
P501		1 ~ 247	1
Description	Each screwdriver set can have a ID number for RS232/485 serial interface communication.		

27) COM port protocol setting

Number	Unit	Range	Initial																				
P502		0 or 1	5																				
Description	<p>It select the interface protocols for RS232C & RS485</p> <p>Factory setting : 8bit, No parity, 1stop bit, 57600bps, ASCII</p> <p>▶ 1st digit</p> <table border="1"> <thead> <tr> <th>Numeric code</th> <th>Baud rate</th> </tr> </thead> <tbody> <tr> <td>0</td> <td>9600bps</td> </tr> <tr> <td>1</td> <td>14400bps</td> </tr> <tr> <td>2</td> <td>19200bps</td> </tr> <tr> <td>3</td> <td>38400bps</td> </tr> <tr> <td>4</td> <td>56000bps</td> </tr> <tr> <td>5</td> <td>57600bps</td> </tr> </tbody> </table> <p>▶ 3rd digit</p> <table border="1"> <thead> <tr> <th>Numeric code</th> <th>Serial interface</th> </tr> </thead> <tbody> <tr> <td>0</td> <td>RS232</td> </tr> <tr> <td>1</td> <td>RS485</td> </tr> </tbody> </table>			Numeric code	Baud rate	0	9600bps	1	14400bps	2	19200bps	3	38400bps	4	56000bps	5	57600bps	Numeric code	Serial interface	0	RS232	1	RS485
Numeric code	Baud rate																						
0	9600bps																						
1	14400bps																						
2	19200bps																						
3	38400bps																						
4	56000bps																						
5	57600bps																						
Numeric code	Serial interface																						
0	RS232																						
1	RS485																						

■ **Input signal pin assignment for parallel interface**

Numeric code	b	A	9	8	7	6	5	4	3	2	1	0
I/O no.	ON	Input 10	Input 9	Input 8	Input 7	Input 6	Input 5	Input 4	Input 3	Input 2	Input 1	OFF
Pin no.		28	27	26	9	8	7	6	5	4	3	

Example) If you want to assign START input signal on INPUT 3, select "3" on the 4th digit of display panel on the P1.00

Smart manager is much easy to assign the signal I/O

28) P1.00 Input signal assignment I

Range : 0~b, 0= Normal Off, b= Normal On, 1~7 = digital input

Numeric code	Signal assignment	Factory setting	Pin no.
0	Torque select 1	1	Pin 3
1	Torque select 2	2	Pin 4
2	Torque select 3	3	Pin 5
3	Start	4	Pin 6

29) P1.01 Input signal assignment II

Range : 0~b, 0= Normal Off, b= Normal On, 1~7 = digital input

Numeric code	Signal assignment	Factory setting	Pin no.
0	Fasten/Loosen	5	Pin 7
1	Mult sequence	6	Pin 8
2	Alarm reset	7	Pin 9
3			

■ **Output signal pin assignment for parallel interface**

Numeric code	6	5	4	3	2	1	0
I/O no.	Output 6	Output 5	Output 4	Output 3	Output 2	Output 1	OFF
Pin no.	39 & 40	38 & 40	37 & 40	47 & 48	43 & 44	41 & 42	

Example) If you want to assign Fastening OK output signal on OUTPUT 1,
 select "1" on the 3rd digit of display panel on the P1.12
 Smart manager is much easy to assign the signal I/O

30) P1.12 Output signal assignment I

Range : 0~9, 0= Normal OFF, 1~6 = digital output

Numeric code	Signal assignment	Factory setting	Pin no.
0	Status F/L	4	Pin 37 - 40
1	Torque up	5	Pin 38 - 40
2	Fasten OK	3	Pin 47 -48
3	Warning	6	Pin 39 - 40

31) P1.13 Output signal assignment II

Range : 0~9, 0= Normal OFF, 1~6 = digital output

Numeric code	Signal assignment	Factory setting	Pin no.
0	Ready	1	Pin 41 - 42
1	Run	2	Pin 43 - 44
2	Error code 1	0	
3	Error code 2	0	

32) P1.14 Output signal assignment III

Range : 0~9, 0= Normal OFF, 1~6 = digital output

Numeric code	Signal assignment	Factory setting	Pin no.
0	Error code 3	0	

7.9 Controller inspection period and trouble shooting

SHC controller is equipped with electronic circuit. The dust and particles may cause the controller to be damaged. The regular cleaning is required every year.

1) inspection and pre maintenance period

Item	Period	Inspection	Action
Cleaning of Main Body and Board	1 year	dust, particles or oil	Clean out these contaminations
Wire connections	6 months	loosening of socket, connector, nut and others	Retighten connections firmly.
Functional inspection	1 or 2 year	heat, noise, damage or open circuit	Inquiry to the company

CAUTION



Do not open the controller. If the controller seal is open or removed, the warranty will be expired.

3) Controller Warning

Warning is provided to protect damage from abnormal environment by function by the self-diagnosis.



Warning indicator

The warning is displayed on the last 3 digit of 7-segment as shown on the above. The character displayed the normal operation status does not flicker, but once the abnormality applicable for controller warning is detected, the applicable character is displayed and flickers.









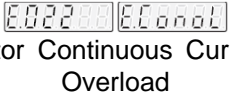
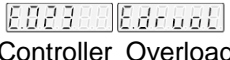

Controller Warning trouble shooting action

Warning display	Cause	Action
<p>Digital I/O allocation error</p>	Digital input or output of the allocation is inappropriate.	<ul style="list-style-type: none"> - When working in the preset mode, check if it is allocated for preset. - When working in the normal / override mode, check if it is allocated for override function.
<p>Over motor capacity</p>	It occurs when motor power is set higher than the controller capacity	Use a motor suitable to the controller





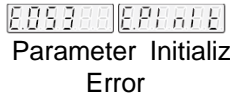

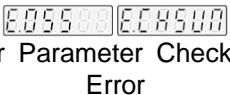

4) Controller alarm

By the self-diagnosis, there is the servo alarm that displays the important errors. It displays 3 digits of error code and 5 digits of text message in turn.

Alarm code / message	Cause	Action
<p>Motor overheat</p>	<ol style="list-style-type: none"> 1. Over current by high ambient temperature surrounding the motor 2. motor wiring error 3. motor selection error 	<ol style="list-style-type: none"> 1. Lower the ambient temperature or increase the motor cooling. 2. Motor wiring check 3. select proper motor
<p>IPM error</p>	<ol style="list-style-type: none"> 1. Motor cable short 2. Motor winding short 3. over rated power capacity 4. Internal over current 	<ol style="list-style-type: none"> 1. motor cable check 2. Rotate the motor shaft by hand. If it does not run smoothly, replace motor
<p>BUS Low Voltage</p>	<ol style="list-style-type: none"> 1. AC power input is low. 2. Controller power on without main power input 	<ol style="list-style-type: none"> 1. Check the AC input voltage or voltage drop by noise 2. Main power input

 Bus over voltage	1. Over input voltage or 2. Over voltage of regeneration power	1. Check input voltage 2. Check regeneration voltage
Alarm code / message	Cause	Action
 Motor Over Speed	Motor speed exceeds the maximum	1. Encoder cable check 2. Motor cable check
 Motor Continuous Current Overload	the internal filter that protects the motor from overheating trips.	1. Increase fastening cycle time 2. Increase capacity of motor and controller
 Controller Overload	average current exceed the rated capacity	1. Increase fastening cycle time 2. Increase capacity of motor and controller
 Encoder Date Range Error	1. The encoder is not properly programmed. 2. The memory of the encoder is damaged.	Replace the motor
 Encoder cable open error	1. Communication failure with encoder 2. Hall sensor error	1. Check the motor 2. Check encoder cable
 Encoder Data Parameter Error	1. The encoder is not properly programmed. 2. The memory of the encoder is damaged.	Replace the motor
 Controller overheat	Controller is overheated	1. Increase fastening cycle time 2. Increase capacity of motor and controller
 AC line Loss	1. AC power input is low. 2. Controller power on without or earlier than main power input	1. Check the AC input voltage or voltage drop by noise 2. Main power input
 User Parameter Initialization Error	An error exists in the parameter saved in the memory.	Initialize the parameter to factory setting
 Current feedback offset	Defective hardware	Replace controller
 User Parameter Checksum Error	Parameter Checksum Error	1. Check the parameter and reset. 2. Initialize to the factory settings.

 <p>WatchDog time out</p>	<p>Defective hardware or noise interference</p>	<ol style="list-style-type: none"> 1. Wiring and installation check 2. Replace controller
--	---	---



Alarm code / message	Cause	Action
 PWM Hardware Error	Defective hardware	Replace or repair controller
 User Parameter Range Error	Parameter range is invalid.	1. Input the parameter within the range. 2. Initialize to the factory settings.
 Controller Initialization Error	Defective hardware	Replace or repair controller
 Regenerative Overload Protection	Regeneration resistance is separated or damaged.	Check the connection or value of the regeneration resistance.
 Regenerative Over current Protection	The regenerative current exceeds the allowable instant value.	Check if the regeneration resistance is shorted or damaged.
 Controller setting	The controller operation mode and the screwdriver selection are not compatible.	Check parameter setting
 Motor power cable open	Motor power cable is not connected	Check the motor power cable
 Motor continuous current overload	defective current feedback detection	Check the cable connection
 Motor Mismatch Fault	Wrong motor connected	Check the motor
 Encoder Type Mismatch	Defective Encoder	Replace motor
 Encoder Communication Error	1. Defective encoder cable 2. encoder signals are interrupted by the EMI (noise).	Check encoder cable and EMI
 Emergency stop	Emergency Stop (E-STOP) is detected.	Reset the E-Stop condition

Alarm code / message	Cause	Action
<p>E.11488 E.666UR Motor Phase Over current</p>	<ol style="list-style-type: none"> When the error occurs while turning on the power, there is a problem in the control or main power circuit. When this error occurs while in operation, over current exists. (Current that is 300 [%] over the rated current is supplied to the motor at more than 250 [ms]). 	<ol style="list-style-type: none"> Check the wiring and the power. Check the power and set or adjust the acceleration/deceleration time.
<p>E.08488 E.NUL65 Multi sequence setting error</p>	Wrong program of multi sequence	Correct the program of multi sequence
<p>E.08588 E.FA6UR Controller error</p>	Wrong controller model	<ol style="list-style-type: none"> Not compatible controller from other manufacturer Repair the controller
<p>E.20188 E.EA6NE Over max angle error</p>	No torque up after the Max angle value on P024~031	Tightening pattern error Manual Rest or Auto Reset
<p>E.20288 E.FA6N1 No torque up error</p>	stopped with No torque up after the Min angle value on P016~023	Tightening pattern error Manual Rest or Auto Reset
<p>E.20388 E.FA6N2 Torque up before Min angle</p>	stopped by torque up before the Min angle value on P016~023	Tightening pattern error Manual Rest or Auto Reset
<p>E.20488 E.FA66E Fastening time limit</p>	Fastening time is over than the value on P308	Tightening pattern error Manual Rest or Auto Reset
<p>E.20588 E.L66UE Loosening time limit</p>	Loosening time is over than the value on P309	Tightening pattern error Manual Rest or Auto Reset
<p>E.20688 E.L66CE Motor stall</p>	Motor is stalled on loosening process over the time on P314	Motor protection feature from overheat Manual Rest or Auto Reset
<p>E.20788 E.EA6RL Angle limit over during Ramp-up</p>	Rotation angle is over the value on P210 during Ramp-up process	Tightening pattern error Manual Rest or Auto Reset
<p>E.20888 E.HA6RL Angle limit over during Torque holding(Tm)</p>	Rotation angle is over the value on P209 during Torque holding process	Tightening pattern error Manual Rest or Auto Reset

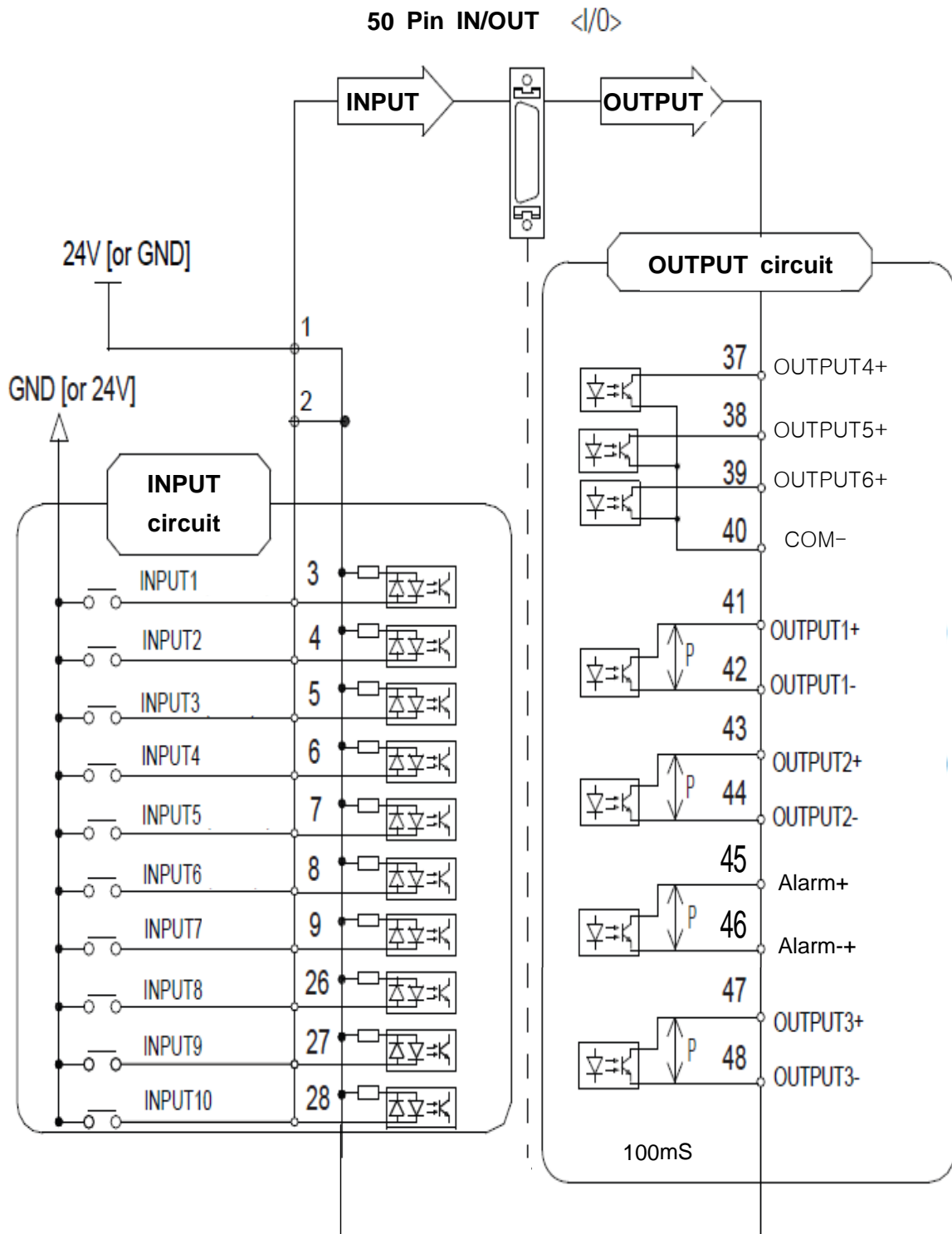
7.10 50 pin I/O circuit



7.11 50 pin I/O details (Factory setting)

PIN no.	Description (factory setting)	IN / OUT	
1	Input COM (24V+ or GND)	<p style="text-align: center;">Input</p> 	
2			
3	Input 1 (Torque select 1)		
4	Input 2 (Torque select 2)		
5	Input 3 (Torque select 3)		
6	Input 4 (Start)		
7	Input 5 (Fasten/Loosen)		
8	Input 6 (Multi sequence)		
9	Input 7 (Reset)		
26	Input 8 (not use)		
27	Input 9 (not use)		
28	Input 10 (not use)		
37	Output 4(+) (Status F/L)	<p style="text-align: center;">Output</p> 	
38	Output 5(+) (Torque up) - without verifying result		
39	Output 6(+) (Warning)		
40	Output 4,5,6 COM (-)		
41	Output 1(+)		(Ready)
42	Output 1(-)		
43	Output 2(+)		(Run)
44	Output 2(-)		
45	Alarm (+)		Alarm (fixed)
46	Alarm (-)		
47	Output 3(+)	(Fastening OK)	
48	Output 3(-)	- Verifying OK	

7.12 Error code output

In order to get error code, Select output 4, 5 and 6 for error code 1, 2 and 3 on parameter P1.13 and P1.14.

The below table shows a example selection of error code outputs.

Pin no. 37, 38 and 39 for output 4,5 and 6 works with pin no. 40 as a COM(-).

Error code	Error code 3 Output4 (pin no. 37)	Error code 2 Output5 (pin no. 38)	Error code 1 Output 6 (pin no. 39)
No use	0	0	0
System error (4,5,23,18,19,35,57,79,101,102,114, 85,75,36,22,60,100)	0	0	1
Fastening error (201,202,203)	0	1	0
Fastening sequence error (84,204,205,205,207,208)	0	1	1
E-stop, watch Dog (56,112)	1	0	0
Motor or Encoder error (28,30,31,86,103,105,106)	1	0	1
Power error (9,10,37)	1	1	0
Farameter error (53,55,58,107,113)	1	1	1

7.13 I/O timing chart

1) Fastening OK

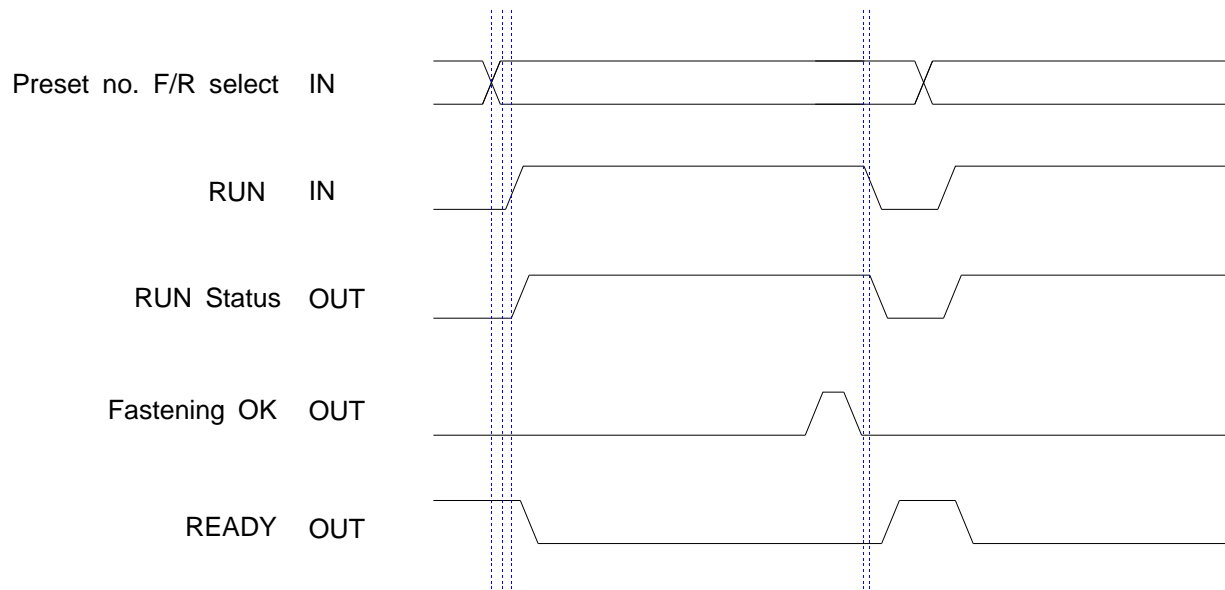

2) Fastening NG

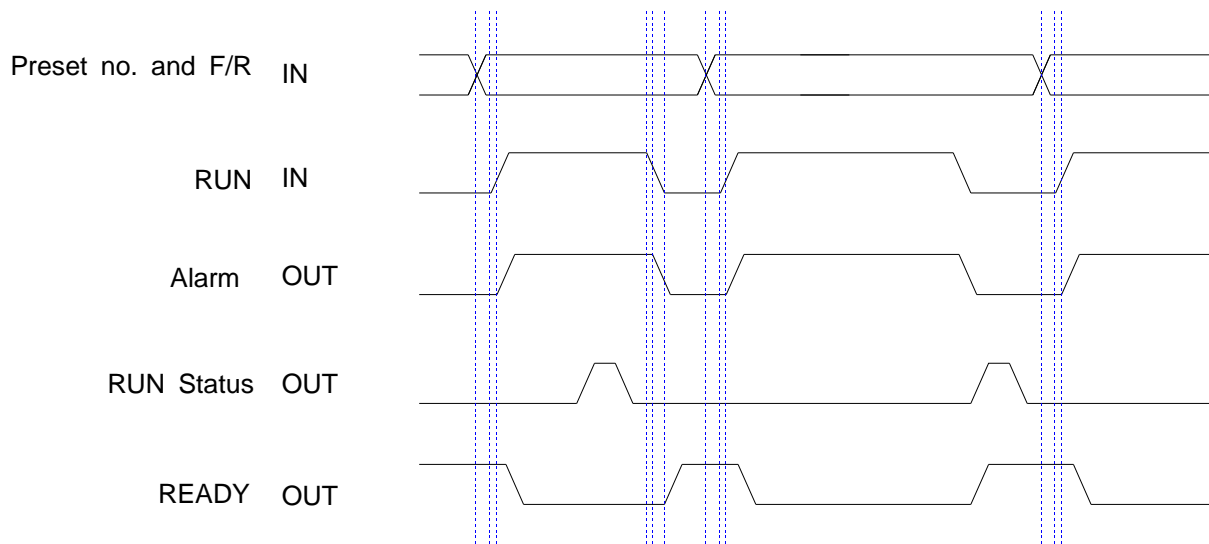

8. PC communication software, *Smart-Manager (for MS Windows)*

With free PC communication software, Smart-Manager, it is easy to set the parameters including torque, speed, fastening monitoring and quality control.

For changing parameters of controller by PC software, it require Log-in password.

For the manager Log-in password of Smart-Manager software, please contact to the distributor or service center. The password can not be open to operators without agreement of managing group. Smart-Manager without Log-in is available by request, too

8.1 Software install

- PC Operating System : MS Windows (2000, XP, Vista)
- Display : 1024 x 768 (Optimized)

The Smart-Manager software require MS Dot Net framework v 4.0 or higher on your OS before install.

Window 2000 and XP can be updated with Dot Net framework on the download center of Microsoft web site. (www.microsoft.com).

Microsoft .NET Framework ver 4.0

8.2 Operation

- Smart-Manager software setup.
- Open the **Smart-Manager** software
- Select the Comport no and click OK
- Click " READ ALL " menu for read all parameters from the connected SHC-XXX controller.
- For changing parameter, it require Manager Log-in password.

If you can find Controller and Driver Information on the opening page as below, the communication is successful.

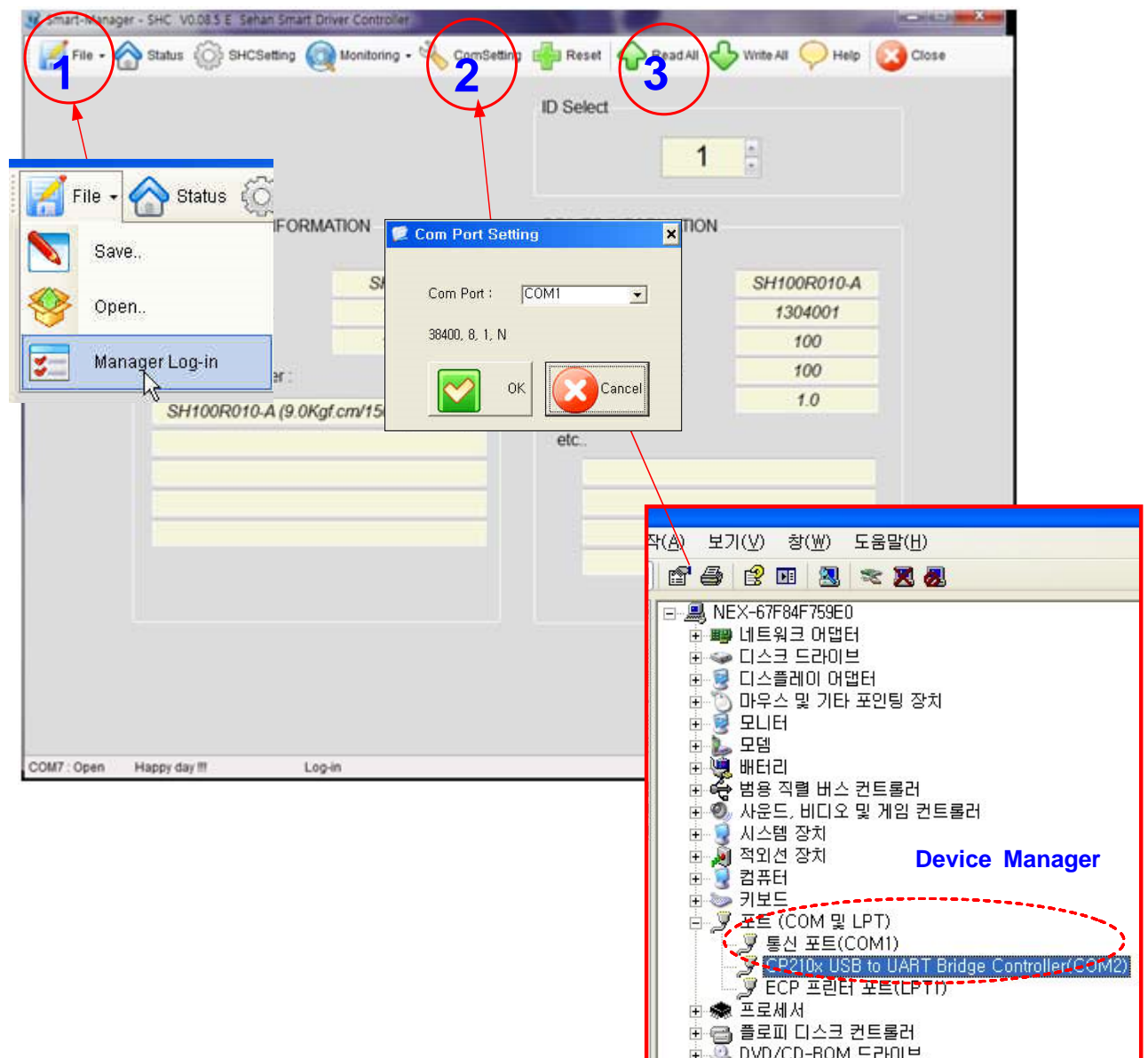

8.3 SHC controller firmware upgrade

The controller firmware can be upgraded on the Smart Manager.

- 1) Click File menu and open " Upgrade Firmware "
- 2) Open the latest firmware
- 3) Click "DOWN"
- 4) Once you upgrade the firmware, power the controller OFF and ON again.

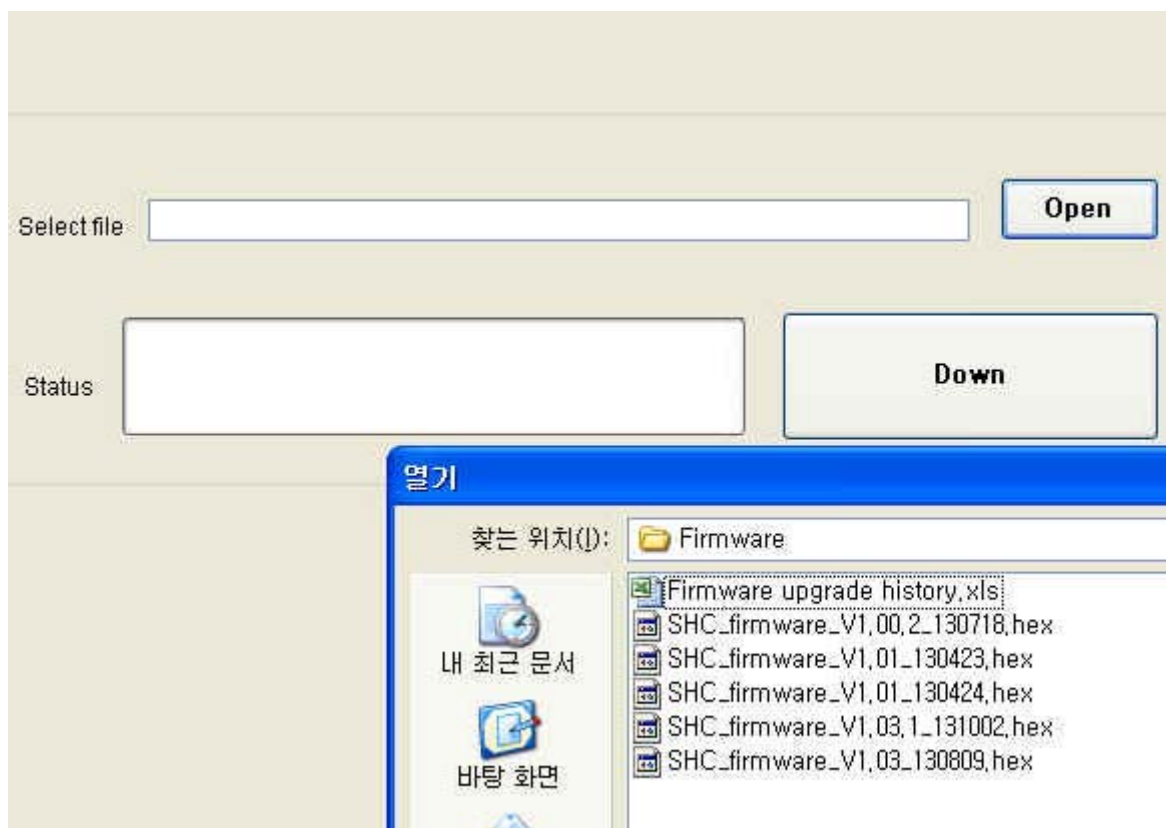
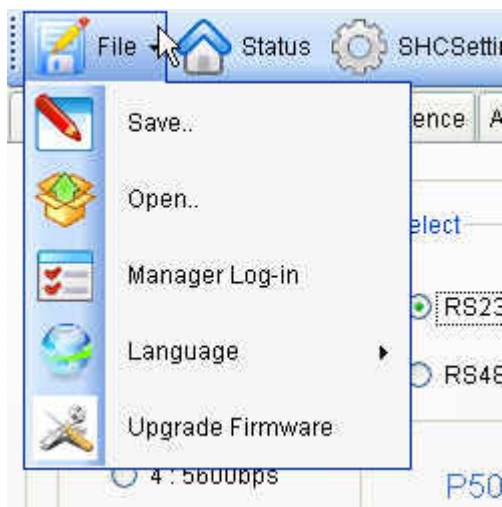

8.4 Parameter setting on *Smart-Manager*

1) Fastening Setting (SHC-xxx Setting -->)

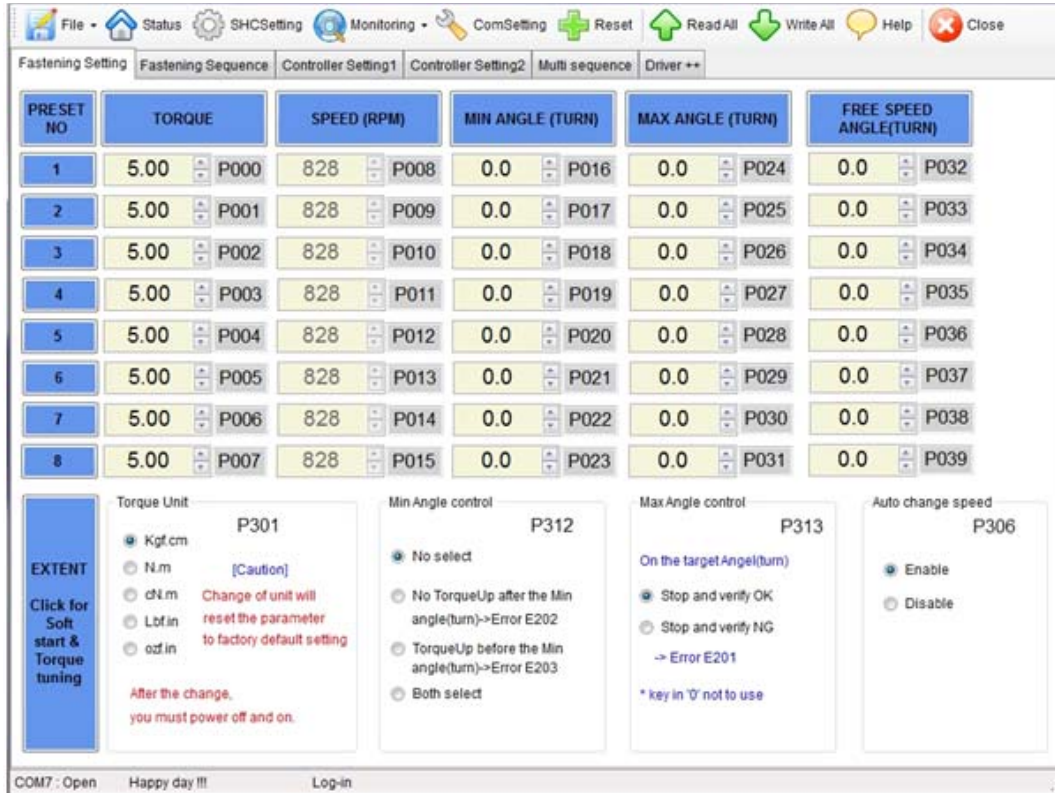

- Select the torque unit before setting other parameters. Otherwise all parameters changed to the factory setting after change of torque unit.
- Change or select parameters, and Click " WRITE ALL" menu to write new settings on the connected SHC-24 controller.
- To allow parameter change, be sure that it require **Manager Log-in** on File menu. Ask to the distributor for the **Log-in password**.
- Monitoring is possible without Manager Log-in.

2) Profile of fastening process

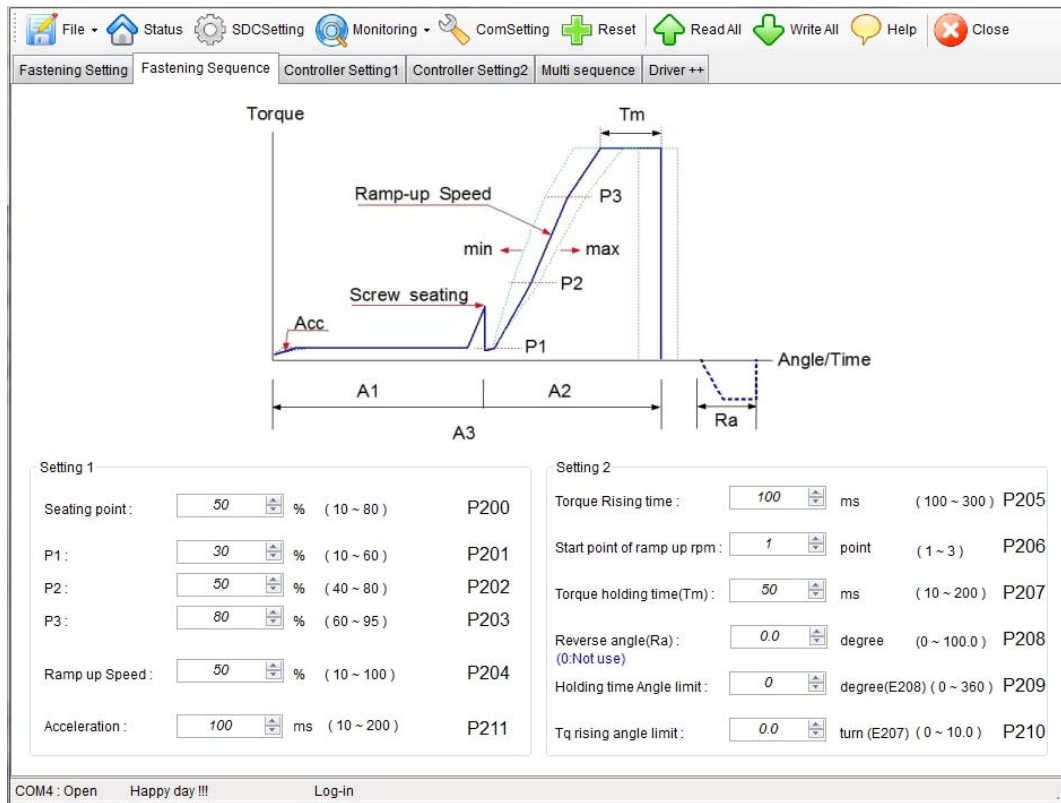

** Refer to 5.6 Parameter details

3) Multi Sequence Setting (SHC Setting -->)

The screenshot shows the 'Multi sequence' window with two modes, Mode A and Mode B, and a help section. The tables are as follows:

Step NO	Command	Parameter
STEP 1	NOP	0
STEP 2	NOP	0
STEP 3	NOP	0
STEP 4	NOP	0
STEP 5	NOP	0
STEP 6	NOP	0
STEP 7	NOP	0
STEP 8	NOP	0
STEP 9	NOP	0
STEP 10	NOP	0

Step NO	Command	Parameter
STEP 1	NOP	0
STEP 2	NOP	0
STEP 3	NOP	0
STEP 4	NOP	0
STEP 5	NOP	0
STEP 6	NOP	0
STEP 7	NOP	0
STEP 8	NOP	0
STEP 9	NOP	0
STEP 10	NOP	0

Command	Explanation
NOP	No operation
Fastening()	Start fastening (Preset no)
End	End of programing
Delay()	Time delay (unit 10ms)
Jump	Jump to the step number
Select Preset#	Select preset number

Command	Explanation
Loosening	Start reverse rotation, if there is target angle(turn), it stop at the set angle (unit: 0.1 turn)
Count Value = A	Count value setting
Sub If (A)	Avalue = A - 1 if A = 0 : 2nd step jump and execution if A != 0 : next step execution

** Mode A, B comes after preset # 8 with displaying of mA, mB.

※ Explanation details of JUMP, COUNT VALUE=A, SUB IF(A) command

■ Example multi sequence program

Step NO	Command	Parameter
STEP 1	Count Value = A	10
STEP 2	Fastening	1
STEP 3	Loosening	5
STEP 4	Fastening	3
STEP 5	Sub If (A)	0
STEP 6	Jump	2
STEP 7	End	0
STEP 8	NOP	0
STEP 9	NOP	0
STEP10	NOP	0

The above multi sequence shows 10 times repeat of steps from 2 to step 5, and finish cycle completely.

- Count value = A

Count number of step selected or operated

- Sub if (A)

If the counted number A (on step 1), is not 10, go to the next step (6)

If the counted number A (on step 1), go the 2nd next step (7).

- Jump

Move to the setting step (2)

Signal output

Fastening OK signal output after all sequence.

Each fastening step - torque up output

4) Driver ++ setting

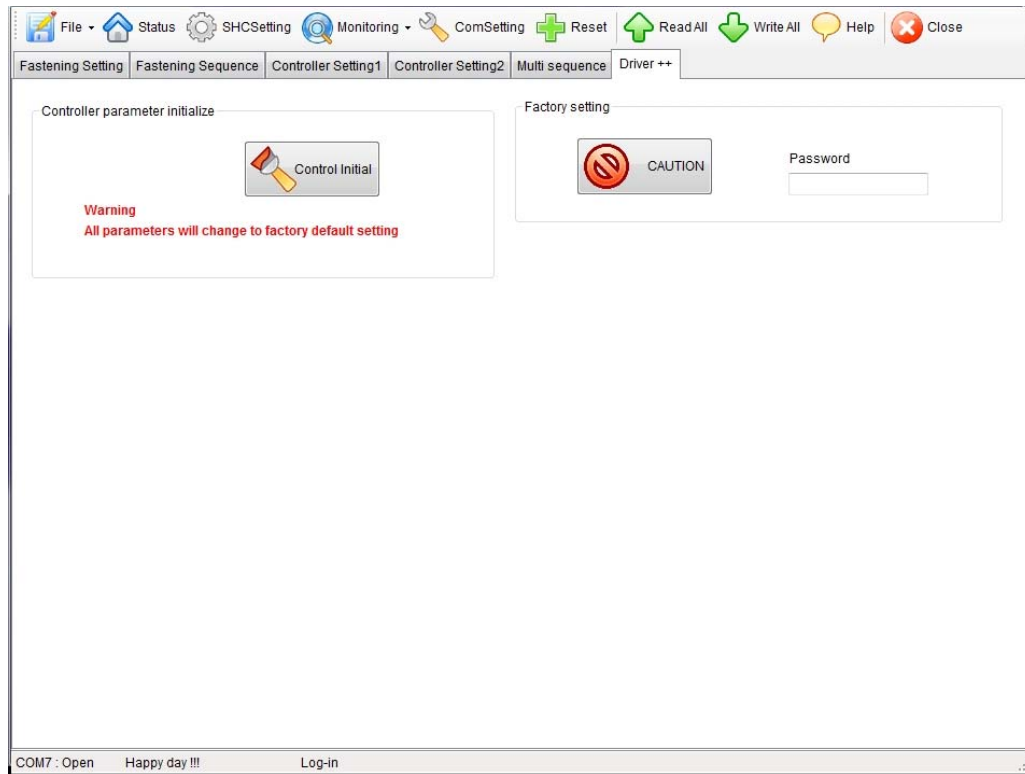

5) Real-time Monitoring data

Number	Time	F_Time	Preset	T/Tq	C/Tq	Speed	A1	A2	Angle(A3)	Error	F/L	Status
1	2013-04-05 오후 ...	0.626	1	1.50	0.000	367	0	0	3.51	-	F	-
2	2013-04-05 오후 ...	0.618	1	1.50	0.000	367	0	0	3.47	-	F	-
3	2013-04-05 오후 ...	0.522	1	1.50	0.000	367	0	0	2.88	-	F	-
4	2013-04-05 오후 ...	0.807	1	1.50	1.506	367	3.68	0.07	3.76	-	F	OK
5	2013-04-05 오후 ...	0.866	1	1.50	1.483	367	4.03	0.09	4.13	-	F	OK
6	2013-04-05 오후 ...	0.768	1	1.50	1.495	367	3.44	0.06	3.5	-	F	OK
7	2013-04-05 오후 ...	4.961	1	1.50	0.000	367	0	0	5.14	-	L	-
8	2013-04-05 오후 ...	4.371	1	1.50	0.000	367	0	0	4.41	-	L	-
9	2013-04-05 오후 ...	0.820	1	1.50	1.490	367	3.76	0.06	3.82	-	F	OK
10	2013-04-05 오후 ...	0.796	1	1.50	1.533	367	3.61	0.07	3.69	-	F	OK
11	2013-04-05 오후 ...	0.856	1	1.50	1.496	367	3.98	0.05	4.03	-	F	OK
12	2013-04-05 오후 ...	0.880	1	1.50	1.500	367	4.12	0.07	4.19	-	F	OK

COM7 : Open Happy day!! Log-in

** The data can be saved in CSV format file.

6) Real-time Torque & speed curve

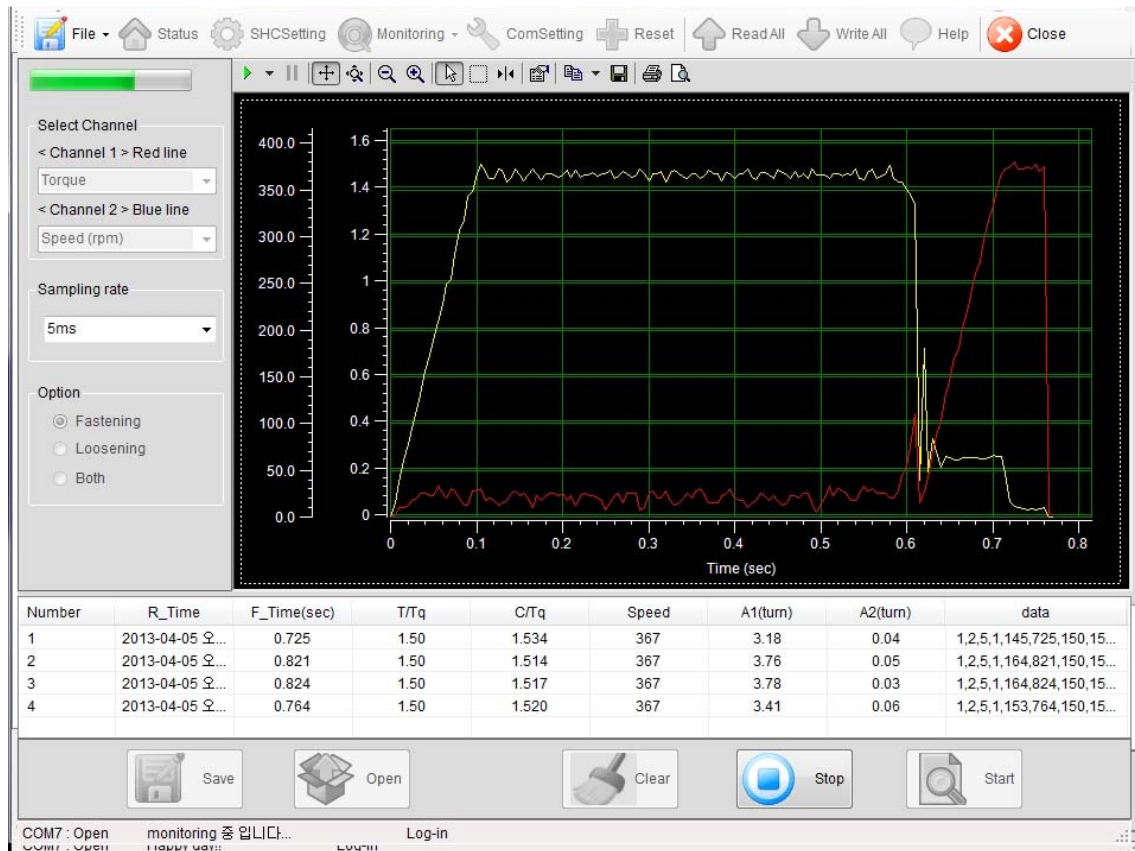

- Data sampling rate : 1 ~ 20mS (selectable)
- Data and curve can be saved in a file (*.cgd).
- Graph data select : Torque or current, Angle, Speed etc.

7) Alarm history

NO	ERR NO	Error History
1	80	E,201 FATMT Fastening Max Turn
2	80	E,201 FATMT Fastening Max Turn
3	82	E,203 FATM2 Fastening Min2
4	80	E,201 FATMT Fastening Max Turn
5	80	E,201 FATMT Fastening Max Turn
6	80	E,201 FATMT Fastening Max Turn
7	80	E,201 FATMT Fastening Max Turn
8	31	E,030 ENCOP Encoder open

SAVE CLOSE

8.5 COM port and cable specification

1) RS232 cable pin details

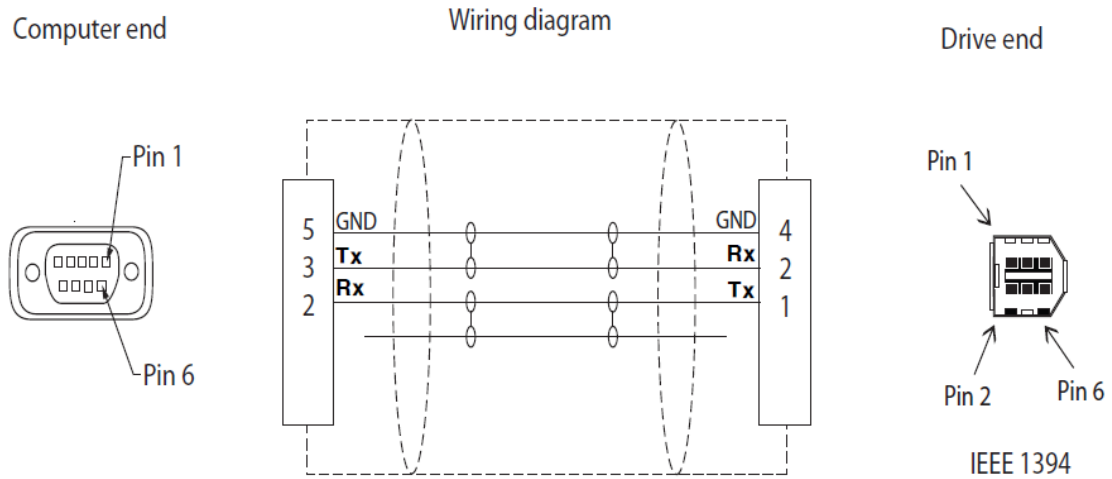

2) RS485 cable pin details

Controller	signal
5	DX+
6	DX-
4	GND

3) RS232C Baud rate change

■ **Change Baud rate of SHC controller first, then change Baud rate on Smart Manager**

- Before you change the Baud rate on the Smart Manager, please check the Baud rate on the controller.
- On the COM port menu of Smart Manager, the Baud rate can be selected. Be sure that you have to select the same Baud rate with the controller setting. **Lower Baud rate than 57600 bps can not support the real time torque curve display.**

- Once you change Baud rate on the Smart Manager, close the program and open it again to communicate with the SHC controller with change Baud rate.

■ Baud rate change of SHC controller

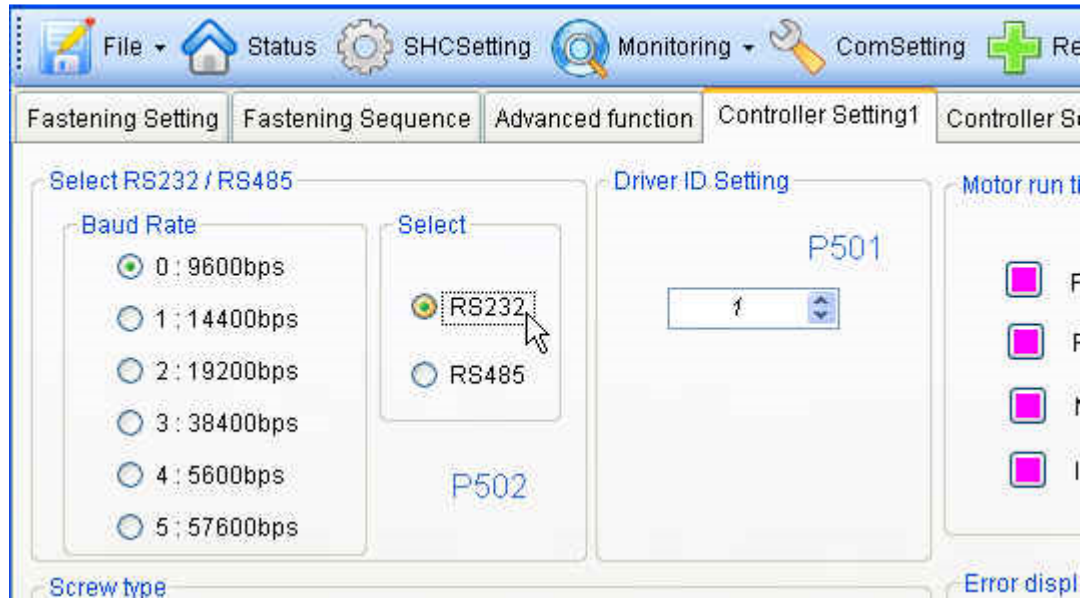

■ Baud rate change of Smart Manager

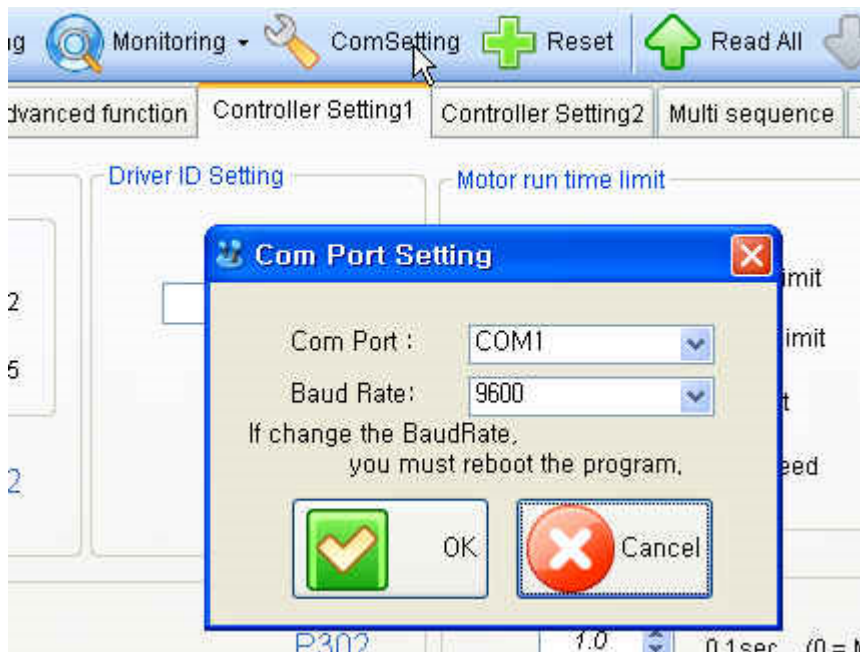

8.6 SHC controller communication Protocol

1) Protocol frame

1byte	2byte	1byte	3byte	0 ~ n byte	1byte	1byte	1byte
STX	dd	# or \$	CMD	Data	:	cc	ETX
Start	ID	Host/respond	command	(data)	seperator	Checksum	1byte

- Baud rate : 19200 BPS (selectable)
- Data bit : 8bit
- Parity : None
- Stop Bits : 1

400 bytes are maximum packets. All command start with STX, end with ETX.

2) Communication control letter

Name	Word	Value	Description
Packet start	STX	0x02	Packet start at the first of the message.
Packet finish	ETX	0x03	Packet end at the last of the message.
OK response	ACK	0x06	OK response on the message receipt
System running	GS	0x1D	Parameter can not be changed during running
Over range	RS	0x1E	over setting range
Invalid	US	0x1F	Invalid command
NOK response	NAK	0x15	Communication error (Checksum error)
Command cancel	CAN	0x18	Cancel command

3) Command

The command for data request and response are as below.

no	Description	Command
1	Read parameter	SET
2	Write parameter	STR: Write parameter on RAM and save in flash memory CHP: Write parameter on RAM
3	Alarm reset	RST
4	Read error history	EHY
5	Firmware versin	VER
6	Connection check	LIV
7	Data monitoring	MOR
8	Graph monitoring	MOT

4) Check sum(BCC)

It add all binary number within Check sum range and convert to 1 Byte of ASCII code. The "35H" is check sum result (BCC) in the example shown.

STX	dd	# or \$	CMD	Data	:	cc	ETX
-----	----	---------	-----	------	---	----	-----

Example)

STX	0	1	#	V	E	R	:	B	ETX	----- ASCII code
-----	---	---	---	---	---	---	---	---	-----	------------------

2	30	31	23	56	45	52	3A	42	3	----- Hexa code
---	----	----	----	----	----	----	----	----	---	-----------------

```

30 H
31 H
23 H
56 H
45 H
52 H
+ 3A H
-----
1 A B H ----- Hexa code
    ↓
    B H ----- ASCII code of Hexa value "B"
  
```

5) Command details

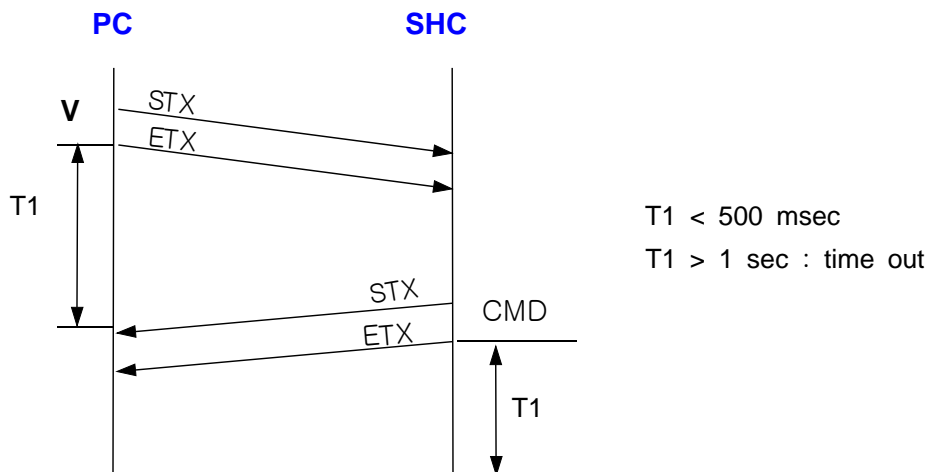

A) Read parameter from controller

Request

STX	ID	#	SET	PPP	:	BSS	ETX
-----	----	---	-----	-----	---	-----	-----

Response

STX	ID	\$	SET	V	:	BSS	ETX
-----	----	----	-----	---	---	-----	-----

ID : (00 - 99)

PPP : 203 (if parameter no. P203)

V : 4 bytes of 16 digits value

B) Write parameter data

- To write parameter on RAM and save on flash memory

Request

STX	ID	#	STR	PPP	V	:	BSS	ETX
-----	----	---	-----	-----	---	---	-----	-----

Response

ACK for OK or GS for impossible by system running

- To check the written parameter,

Request

STX	ID	#	STR	:	BSS	ETX
-----	----	---	-----	---	-----	-----

Response

STX ID \$ BSY : BSS ETX - written Fail

STX ID \$ TOK : BSS ETX - written OK

- To write parameter on RAM.

Request

STX	ID	#	CHP	PPP	V	:	BSS	ETX
-----	----	---	-----	-----	---	---	-----	-----

※The parameter data saved with CHP command will be erased when power OFF

Response

ACK for OK or GS for impossible by system running

C) Alarm reset

Request

STX	ID	#	RST	:	BSS	ETX
-----	----	---	-----	---	-----	-----

Response

ACK

D) Read error history

- To read the history with alarm no.

Request

STX	ID	#	EHY	F1	:	BSS	ETX
-----	----	---	-----	----	---	-----	-----

- Total 8 alarm histories are saved from 0x01 to 0x08.
- The latest history is saved on 0x01

Response

STX	ID	\$	EHYE	FCode	F Chars	:	BSS	ETX
-----	----	----	------	-------	---------	---	-----	-----

- F Code : refer the alarm code details
- F Chars : refer the alarm details

- To read all error histories.

Request

STX	ID	#	EHY	*	:	BSS	ETX
-----	----	---	-----	---	---	-----	-----

Response

STX	ID	\$	EHY	Fcode1&Fcode2&&...Fcode8	:	BSS	ETX
-----	----	----	-----	--------------------------	---	-----	-----

E) Read firmware version

Request

STX	ID	#	VER	:	BSS	ETX
-----	----	---	-----	---	-----	-----

Response

STX	ID	\$	VER	V	:	BSS	ETX
-----	----	----	-----	---	---	-----	-----

example) STX01\$VER 1.00:BSS ETX ver 1.00

F) Check controller connection

Request

STX	ID	#	LIV	:	BSS	ETX
-----	----	---	-----	---	-----	-----

Response

ACK ... Connection is OK

G) Request monitoring data output

Request

STX	ID	#	MOR	:	BSS	ETX
-----	----	---	-----	---	-----	-----

- Request should be repeated within 1 sec. to continue receiving data.
- If P304 is enabled, data output is continued without Request.
Data output can be stopped by ESC command.

Response

STX	ID	\$	MOR	V1,V2,V3,.....V12	:	BSS	ETX
-----	----	----	-----	-------------------	---	-----	-----

- V1 : Serial no. (only if P304 is enabled)
- V2 : Fastening / Loosening time (ms)
- V3 : Preset No.
- V4 : Target torque (unit : 0.01)
- V5 : Converted torque (unit : 0.01)
- V6 : RPM
- V7 : A1
- V8 : A2
- V9 : Rotation angle (unit : 0.01 turn)
- V10 : Error
- V11 : Fastening / Loosening status
- V12 : Complete or Not (OK or -)

H) Request monitoring graph data output

Request

STX	ID	#	MOT	Ch1	Ch2	SP	Opt	:	BSS	ETX
-----	----	---	-----	-----	-----	----	-----	---	-----	-----

Ch1, Ch2	0:Torque, 1:Speed, 3:Current order, 4:Turn, 7:current, 8:Angle
SP	Sampling rate (1 ~ 20ms)
Opt	Option 1: Fastening only, 2: Loosening only, 3:both

- Request should be repeated within 1 sec. to continue receiving data.
 Data output can be stopped by ESC command.

Response

STX	ID	\$	MOT	V1,V2,V3,.....Vn	:	BSS	ETX
-----	----	----	-----	------------------	---	-----	-----

- V1 : Channel 1
- V2 : Channel 1
- V3 : Sampling rate
- V4 : option
- V5 : number of data
- V6 : fastening time
- V7 : target torque
- V8 : Converted torque (cTq)
- V9 : RPM
- V10 : A1
- V11 : A2
- V12 ~ data no. : data of Channel 1
- Vn ~ data no. : Data of Channel 2 (if Channel 2 is selected)